

ACTIVE CUBE

Application manual - Crane drives
Brake control and load detection
Configurations 160, 260 and 460



General points on the documentation

The present documentation supplements the manual for hoisting and lift applications with extended brake control and the function for automatic load detection. The application manual documents the additional functionality of the frequency inverter in the software configurations 160, 260 and 460. These configurations extend the configurations 110, 210 and 410, which are described in the associated manual.

For better clarity, the user documentation is structured according to the customer-specific demands made of the frequency inverter.

Brief instructions

The brief instructions "Quick Start Guide" describe the fundamental steps for mechanical and electrical installation of the frequency inverter. The guided commissioning supports you in the selection of necessary parameters and the software configuration of the frequency inverter.

Operating instructions

The operating instructions document the complete functionality of the frequency inverter. The parameters necessary for specific applications for adaptation to the application and the extensive additional functions are described in detail.

Application manual

The application manual supplements the documentation for purposeful installation and commissioning of the frequency inverter. Information on various subjects connected with the use of the frequency inverter are described specific to the application.

Installation Instructions

Complementing the Brief Instructions and the Operating Instructions, the Installation Instructions provide information on how to install and use the additional/optional components.

The documentation and additional information can be requested via your local representation of the firm of BONFIGLIOLI. The following pictograms and signal words are used for the purposes of the present documentation:



Danger!

means a directly threatening danger. Death, serious damage to persons and considerable damage to property will occur if the precautionary measure is not taken.



Warning!

marks a possible threat. Death, serious damage to persons and considerable damage to property can be the consequence if attention is not paid to the text.



Caution!

refers to an indirect threat. Damage to people or property can be the result.

Attention!

refers to a possible operational behavior or an undesired condition that can occur in accordance with the reference text.

Note

marks information that facilitates handling for you and supplements the corresponding part of the documentation.



Warning! In installation and commissioning, comply with the information in the documentation. You as a qualified person must read the documentation carefully before the start of the activity and obey the safety instructions. For the purposes of the instructions, "qualified person" designates a person acquainted with the erection, assembly, commissioning and operation of the frequency inverters and possessing the qualification corresponding to the activity.

Table of contents

1	General safety and application information	4
1.1	General information.....	4
1.2	Proper use.....	4
1.3	Transport and storage	5
1.4	Handling and positioning.....	5
1.5	Electrical connection.....	5
1.6	Operation information	5
1.7	Maintenance and upkeep.....	5
2	Technical data	6
2.1	Requirements	6
2.2	Control inputs and outputs.....	7
2.2.1	VCB frequency inverter series	7
2.2.2	ACU frequency inverter series	8
3	Commissioning of the frequency inverter.....	8
3.1	Switch mains voltage on.....	8
3.2	Setup with the control unit.....	9
4	Activation of a holding brake	10
4.1	Control inputs and outputs.....	10
4.1.1	Digital outputs.....	10
4.2	Sequence control	11
4.2.1	Current monitoring	12
4.2.2	Frequency monitoring	12
4.2.3	Starting the drive.....	13
4.2.4	Stopping the drive	14
4.2.5	Interrupting the start or stop process	15
4.2.6	Occurrence of a malfunction	15
5	Load detection for hoist application and luffing jib cranes	16
5.1	Load detection for hoist application	16
5.1.1	Mechanical time constant	17
5.1.2	Turns per meter	18
5.1.3	Load estimate	19
5.1.4	Speed switch-off limit.....	20
5.2	Load detection for luffing jib cranes	21
5.2.1	Torque-forming current Isq	23
5.3	Limitation of the speed by fixed frequencies	25
5.4	Temperature adjustment.....	25
6	Parameter list.....	26
6.1	Actual value menu (VAL)	26
6.2	Parameter menu (PARA)	26

1 General safety and application information

This documentation has been produced with the greatest of care and extensively and repeatedly checked. For reasons of clarity, not all the detailed information on all types of the product and also not every imaginable case of erection, operation or maintenance have been taken into account. If you require further information or if specific problems which are not dealt with extensively enough in the documentation exist, you can request the necessary information via the local representation of the firm of BONFIGLIOLI.

We would also point out that the contents of this documentation are not part of a previous or existing agreement, assurance or legal relationship and are not intended to amend the same. All obligations of the manufacturer result from the underlying purchase contract, which also contains the complete and solely valid warranty regulation. These contractual warranty provisions are neither extended nor limited by the production of this documentation.

The manufacturer reserves the right to correct or amend the contents and the product information as well as omissions without prior notification and assumes no kind of liability for damage, injuries or expenditure to be put down to the aforementioned reasons.

1.1 General information

Depending on their protection class, BONFIGLIOLI VECTRON frequency inverters can have live, also moving parts as well as hot surfaces during operation.

In the event of inadmissible removal of the necessary covers, improper use, wrong installation or operation, there is the risk of serious damage to persons or property.

In order to avoid serious physical damage or considerable damage to property, only qualified trained personnel may carry out the work for transport, installation, commissioning and maintenance. The norms EN 50178, IEC 60364 (Cenelec HD 384 or DIN VDE 0100), IEC 60664-1 (Cenelec HD 625 or VDE 0110-1), BGV A2 (VBG 4) and national provisions are to be complied with. Qualified persons within the meaning of this principal safety information are people acquainted with the erection, fitting, commissioning and operating of frequency inverters or in possession of qualifications matching their activities.

1.2 Proper use

The frequency inverters are electrical drive components intended for installation in industrial plant or machines. Commissioning and start of intended operation are not allowed until it has been established that the machine corresponds to the provisions of the EC machine directive 98/37/EEC and EN 60204. According to the CE sign, the frequency inverters additionally fulfill the requirements of the low-voltage directive 73/23/EEC and the norms EN 50178 / DIN VDE 0160 and EN 61800-2. Responsibility for compliance with the EMC directive 89/336/EEC is with the user. Frequency inverters are available in a limited way and as components exclusively intended for professional use within the meaning of the norm EN 61000-3-2.

With the issue of the UL test sign according to UL508c, the requirements of the CSA Standard C22.2-No. 14-95 have also been fulfilled.

The technical data and the information on connection and ambient conditions can be seen from the rating plate and the documentation and are to be complied with at all costs.

1.3 Transport and storage

Transport and storage are to be done in an adequate way in the original packaging. Storage shall be in dry rooms protected against dust and moisture with slight temperature fluctuations. Please observe the climatic conditions according to EN 50178 and the marking on the packaging.

The duration of storage without connection to the admissible reference voltage may not exceed one year.

1.4 Handling and positioning

The frequency inverters are to be used according to the documentation, the directives and the norms. Ensure careful handling and avoid mechanical overloading. In transport and handling, do not bend the construction elements or alter the insulation distances. Do not touch any electronic construction elements and contacts. The devices contain construction elements with a risk of electrostatic, which can easily be damaged by improper handling. Damaged or destroyed components may not be put into operation as they can be a risk to your health and compliance with the applied norms is not guaranteed.

1.5 Electrical connection

In work on the frequency inverters, please observe the applicable norms BGV A2 (VBG 4), VDE 0100 and other national directives. The information in the documentation on electrical installation and the relevant directives are to be observed. Responsibility for compliance with and examination of the limit values of the EMC product norm EN 61800-3 for variable-speed electrical drive mechanisms is with the manufacturer of the industrial plant or machine.

The documentation contains information on installation correct for EMC. The wires connected to the frequency inverters may not be subjected to an insulation test with a high-test voltage without prior wiring measures.

1.6 Operation information

The frequency inverter may be connected to power supply every 60 s. Consider this for a jog operation of a mains contactor. For commissioning or after an emergency stop, a non-recurrent, direct restart is permissible.

After a failure and restoration of the power supply, the motor may start unexpectedly if the AutoStart function is activated. Install protective equipment if personal injury or material damage is possible.

Before commissioning and the start of the intended operation, all the covers are to be attached and the terminals checked. Check additional monitoring and protective devices pursuant to EN 60204 and the safety directives applicable in each case (e.g. Working Machines Act, Accident Prevention Directives etc.). Before working on the frequency inverter, the latter must be switched off, and you are not allowed to touch live connections immediately as the capacitors can be charged up. Please observe the information and markings on the frequency inverter.

1.7 Maintenance and upkeep

Unauthorized opening and improper interventions can lead to physical injury or damage to property. Repairs on the frequency inverters may only be done by the manufacturer or persons authorized by the latter. Check protective equipment regularly.

2 Technical data

The technical data of the brief instructions and the operating instructions refer to the reference point of the frequency inverter. The reference point of the frequency inverter is defined at the admissible mains voltage and a switching frequency of 2 kHz. This reference point is to be checked according to the requirements and redefined for the operating points of the application if need be.

2.1 Requirements

The functionality in the software configurations 160, 260 and 460 described in this application manual requires a distinct selection of the frequency inverters to be used. The criteria for the design of the frequency inverter relevant for the applications are listed below.

Overload reserve

In these applications, in particular with high-quality hoist application, there is the requirement that the frequency inverter provides an increased overload reserve. The reference points of the frequency inverters and the matching overload for 60 seconds are described in the matching brief instructions and operating instructions.

Holding moment

The change between the raising and lower operating points is to be done without the holding brake, with a low speed of lowering being demanded for the positioning. In addition, an increased holding moment is necessary in order to vent (open) and close the brake free of wear and tear. In the design of the drive system, the available reference current of the frequency inverter at a standstill (rotary frequency zero) is to be taken into account.

Brake transistor

The generator operating point (braking operation) occurring in the applications in which energy flows back into the frequency inverter leads to a rise in the DC link voltage. In order to limit the direct voltage, the frequency inverter adds an external brake resistor via the brake chopper transistor from a certain adjustable threshold value. The latter converts the excess energy into heat. The brake chopper transistor in the frequency inverter and the external resistor are to be dimensioned according to the braking energy to be expected.

Absolute figure or incremental speed sensor

The software configurations described in the application manual differ in the controller structure and the resultant operational behavior. According to the requirements, sensor-less control (configuration 110), sensor-less field-oriented control (configuration 410) or field-oriented control with speed sensor (configuration 210) is to be selected. Thanks to the modular hardware and software, the frequency inverters enable connection of the customary absolute figure or incremental speed sensors.



Warning! This information cannot take every imaginable case of erection, operation or maintenance into account. If you require further information or if specific requirements not treated extensively enough in the application manual exist, you can request the necessary information from the local representation of the firm of VECTRON Elektronik.

2.2 Control inputs and outputs

The modular structure of the frequency inverters enables a wide range of applications on the basis of the available hardware and software functionality. The functionality of the control inputs and outputs described in the brief manual and the operating instructions are extended in the configurations 160, 460 and 260.

2.2.1 VCB frequency inverter series

The following illustration shows a possible solution of connecting the control terminals of the VCB frequency inverter in hoist and lift application.

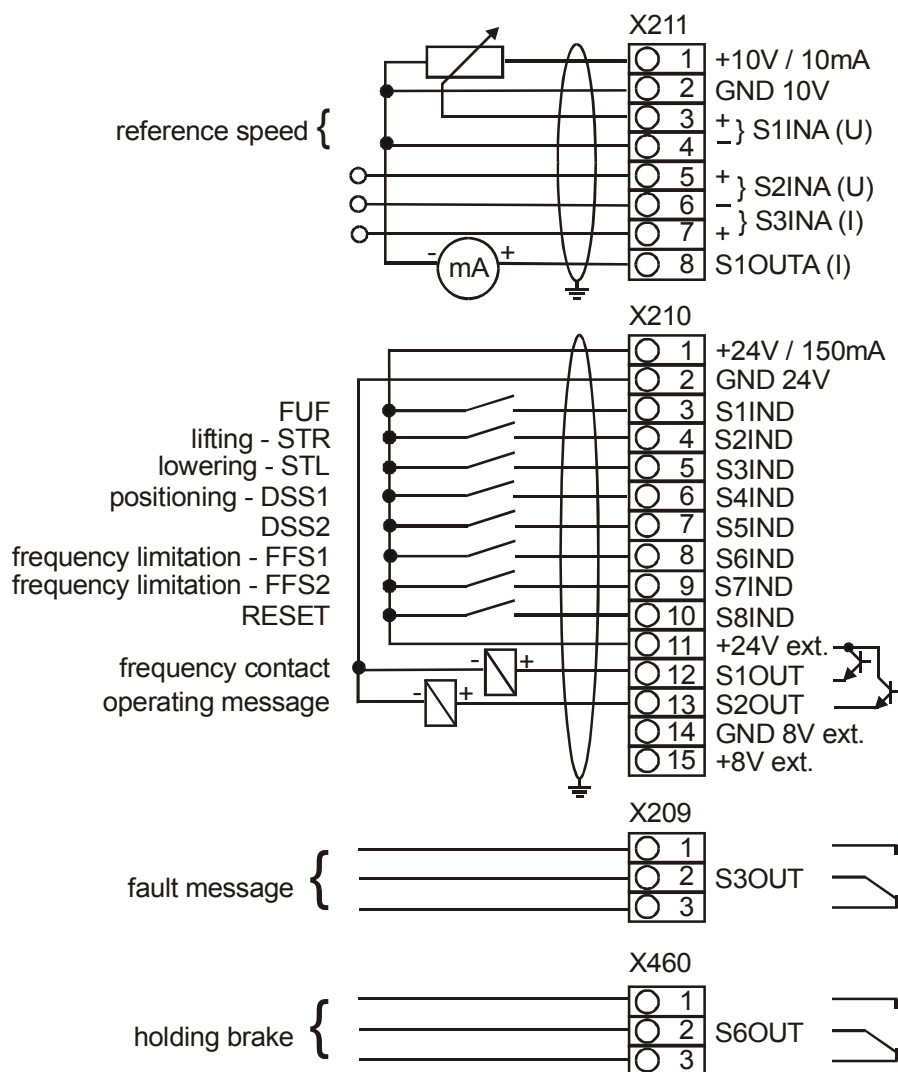

Note: The connection diagram describes the standard configuration of the control terminals. According to the requirements in the application deviating connection possibilities are to be configured by the freely programmable combinations.

In the above connection diagram the holding brake is connected for example with the strip X460 of the extension module EAL-1.

2.2.2 ACU frequency inverter series

The following illustration shows a possible solution of connecting the control terminals of the ACU frequency inverter in hoist and lift application.

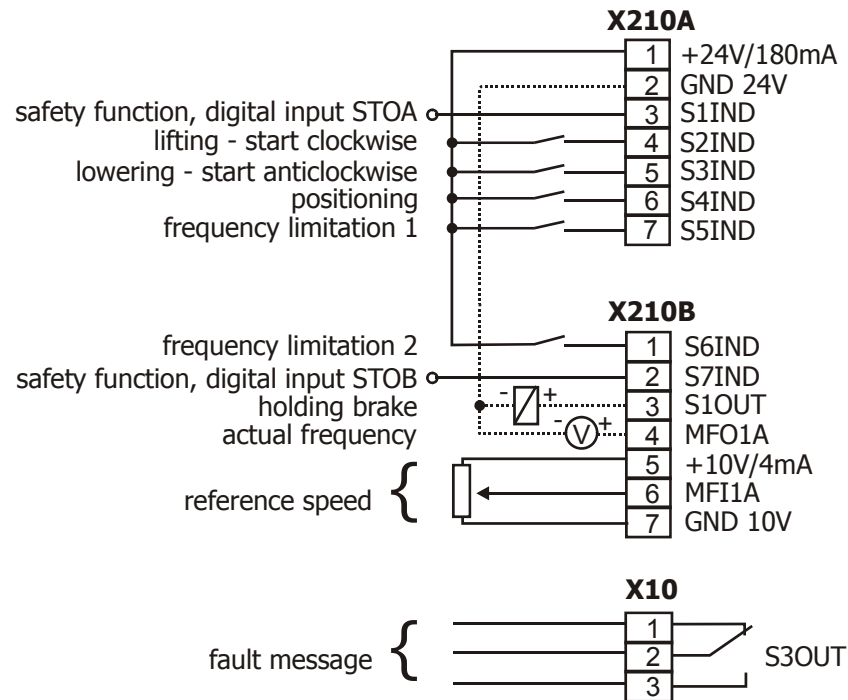

Note: The connection diagram describes the standard configuration of the control terminals. According to the requirements in the application deviating connection possibilities are to be configured by the freely programmable combinations.

The control signals at the terminals X210A.6 and X210A.7 in the above connection diagram are for example linked with the software module for speed sensor evaluation in the configuration 260.

3 Commissioning of the frequency inverter

3.1 Switch mains voltage on

After the installation work has been completed, all the control and power connections should be checked again before the mains voltage is switched on. If all the electrical connections are correct, please ensure that the release of the frequency inverter has been switched off (control inputs S1IND/STOA and S7IND/STOB open). After the mains voltage has been switched on, the frequency inverter makes a self-test and the relay output reports "Fault".

After a few seconds, the frequency inverter completes the self-test, the relay reacts and reports "no fault".

In the state upon delivery and after the setting of the factory settings, the guided commissioning is automatically triggered. The control unit shows the menu point "SETUP" from the menu branch CTRL.



Danger! The functionality of the extended brake control described in this application manual and the connection of the holding brake to the control terminals of the frequency inverter are to be checked at the start of the commissioning. The guided commissioning is to be done with the holding brake closed.

3.2 Setup with the control unit

The guided commissioning of the frequency inverter is described in the operating instructions among others for the configurations 110, 210 and 410. According to the operating instructions, the guided commissioning is to be done observing the safety information and further directives to be observed.

Attention! The guided commissioning contains the function for parameter identification. The parameters are determined and set accordingly by a measurement. Before the start of the measurement, the motor should not have been operated, as a part of the machine data is dependent upon the operating temperature.

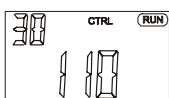

Configuration 110, sensor-less regulation

Configuration 110 contains the functions for variable-speed controls of a 3-phase machine in a large number of standard applications. The motor speed is set according to the V/f characteristic in accordance with the ratio of voltage and frequency.

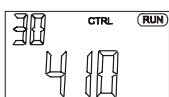

Configuration 410, sensor-less field-oriented control

Configuration 410 contains the functions for sensor-less, field-oriented control of a 3-phase machine. The current motor speed is determined from the present currents and voltages in combination with the machine parameters. Parallel switching of 3-phase motors is only restrictedly possible in this configuration.

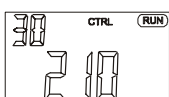

Configuration 210, field-oriented control

Configuration 210 contains the functions for speed-controlled, field-oriented control of a 3-phase machine with speed sensor feedback. The separate control of torque and flux-forming current enables a high drive dynamic with a high torque of load. The necessary speed sensor feedback leads to a precise speed and torque behavior.

After successful completion of the SETUP routine, the matching configuration 160, 260 or 460 for the extended activation of a holding brake and the function for automatic load detection in hoist application is selected via the parameter *Configuration 30* from the menu branch PARA.

4 Activation of a holding brake

In some applications, for example hoist application, elevators or for some machine tools, activation of a holding brake demands an extended functionality for wear-free control of the brake.

In addition, some applications demand, according to directives, that the motor is electrically separated from the frequency inverter by a safety contactor at a standstill. These function modules of the software are activated by the configurations 160, 260 or 460 and supplement the control functions of configurations 110, 210, 410.

The order of events during the start or stop process can be set with the help of the parameters described in the following chapters.



Danger! If a dysfunction of the brake control can lead to major damage, in particular damage to persons, a second independent device for closing the brake must exist. It cannot be ruled out that, for example by damage to the frequency inverter, the brake is released although the frequency inverter has been switched off.

4.1 Control inputs and outputs

The modular structure of the frequency inverters enables a broad spectrum of applications on the basis of the available hardware and software functionality. The functionality of the control inputs and outputs described in the brief instructions and operating instructions is extended in configurations 160, 260 and 460.

4.1.1 Digital outputs

The function "Brake open" in the operating modes 40 and 140 of the digital outputs enables activation of a corresponding unit via the digital control outputs. The function uses not only the control commands via the contact inputs but also the set starting and stopping behavior to control the parameterized digital output. These operating modes of the digital outputs are replaced by the **Operation mode 41** for the extended brake control in configurations 160, 260 and 460.

The function for the activation of the safety switch is to be assigned to one of the digital control outputs with **Operation mode 42**.

Operation mode	Function
41 - Brake open	The digital output becomes active (an open contact closes) when the brake is released.
42 - Safety contactor	The digital output becomes active when the frequency inverter is connected to the motor (safety contactor on).

Attention! For safety reasons, the inverted **Operation mode 141** is not available. In this operation mode, the brake is not released with the digital output active. For example, this would also be the case with a voltage-free frequency inverter or during the initialization phase.

4.2 Sequence control

The logic signals to start and stop the drive can be specified by varying sources. The illustration shows the order of events during starting and stopping the drive with the time constants to be configured and the monitoring functionality to activate the safety switch and the holding brake.

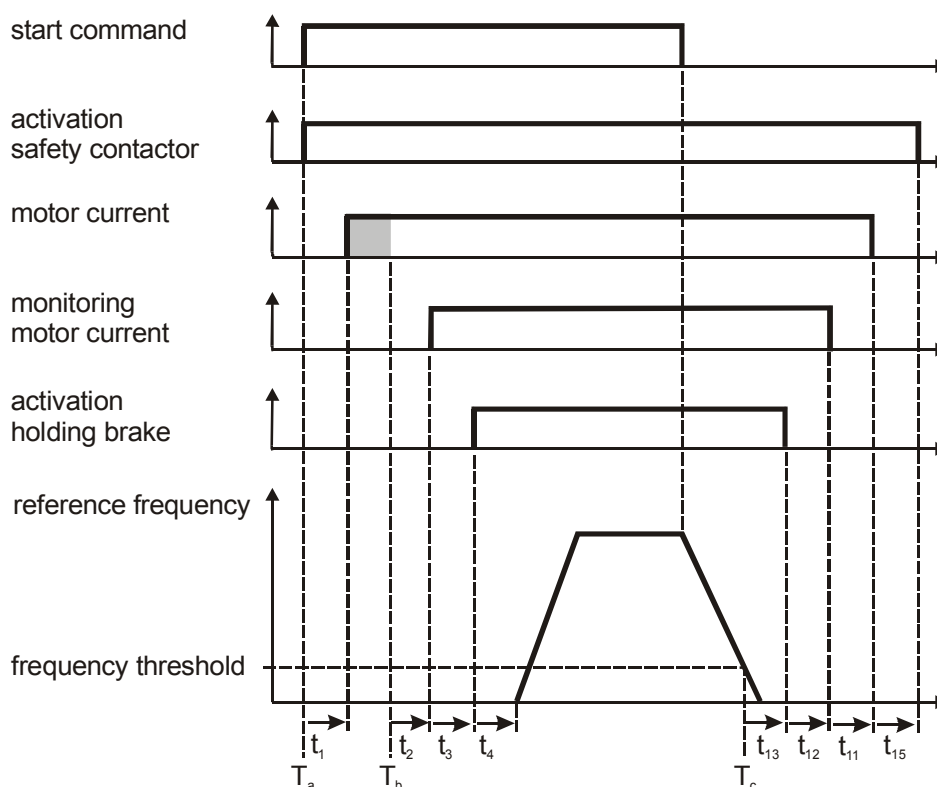

Parameter		Setting		
No.	Description	Min.	Max.	Fact. sett.
800	Time t1 – start of the current impression into the motor	0.0 s	200.0 s	0.0 s
801	Time t2 – start of the motor current monitoring	0.0 s	200.0 s	0.0 s
802	Time t3 – control signal to open the holding brake	0.0 s	200.0 s	0.0 s
803	Time t4 – acceleration of the drive	0.0 s	200.0 s	0.0 s
804	Time t11 – blocking the output signals	0.0 s	200.0 s	0.0 s
805	Time t12 – end of the current monitoring	0.0 s	200.0 s	0.0 s
806	Time t13 – control signal to close the holding brake	0.0 s	200.0 s	0.0 s
807	Time t15 – control signal to open the safety switch	0.0 s	200.0 s	0.0 s

The monitoring of the operation points to activate the holding brake and the safety switch can be set via trigger limits, the lower limit for the motor current monitoring with the *Monitoring current* **808** and the standstill detection with the *Frequency threshold* **809**. The setting is relative to the rated values of the motor and is to be selected by the set *Configuration* **30**.

4.2.1 Current monitoring

The monitoring of the motor current supplements the functionality for the activation of a holding brake. Applications demanding a holding brake accelerate the motor by the specific load behavior when the brake is opened.

The asynchronous motor must be supplied with sufficient current in all operation points in order to provide the necessary torque to avoid damage to property and persons. Possible reasons for a lack of torque on the motor shaft can be a defective motor, a lack of or incorrect motor connection, a defect in the frequency inverter or wrong parameterization. This is why the output current is monitored. If the absolute value of the output current drops below the set threshold *Monitoring current* **808**, the fault "F1310 minimum current monitoring" is triggered. In the event of a fault, the holding brake is closed and the safety switch opened by the frequency inverter or an external monitoring

Parameter		Setting		
No.	Description	Min.	Max.	Fact. sett.
808	Monitoring current	0.0 A	$0 \cdot I_{FIN}$	$0.2 \cdot I_R$

4.2.2 Frequency monitoring

The output frequency of the frequency inverter and the rotary frequency of the motor shaft vary as a function of the load point. The selected control functions and methods contain an estimate of the load point and thus the slip speed or a precise measurement thanks to a speed sensor feedback. The standstill of the drive can thus be determined precisely or also only estimated.

Reliable activation of the holding brake thus demands a *Frequency threshold* **809** relative to the *Maximum frequency* **419**, from which the time t_{13} for the closing of the holding brake is measured.

Parameter		Setting		
No.	Description	Min.	Max.	Fact. sett.
809	Frequency threshold	0.0 %	100.0%	1.0 %

4.2.3 Starting the drive

The order of events until the actual start of the drive can be parameterized via various time constants.

1. The inverter gets the start command via digital input or serial bus.
2. With the start command (time T_a) the safety contactor is switched without delay.
3. After expiry of *Time t1* **800** the magnetizing of the motor starts. If a safety contactor is used, this time must be set longer than its reaction time.
4. After the end of the magnetizing (time T_b) and the expiry of *Time t2* **801** the current monitoring is activated.
5. After expiry of *Time t3* **802** the signal for the release of the brake becomes active.
6. After expiry of *Time t4* **803** the drive starts. The reference speed is increased with the set ramp gradient. This time should be set to the reaction time when releasing the mechanical brake.

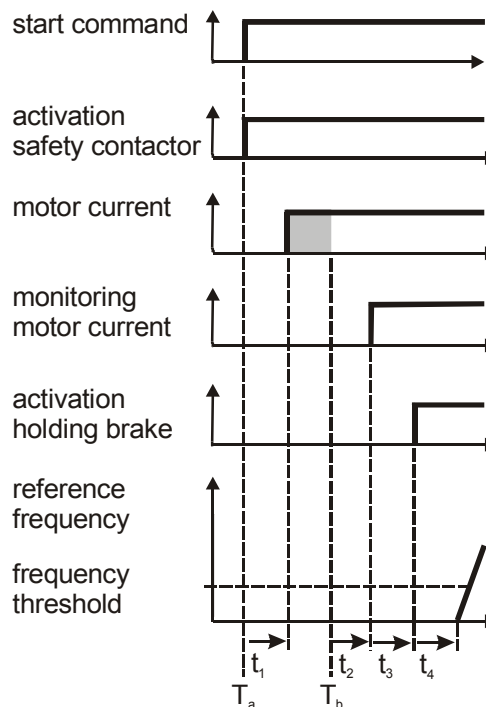

4.2.4 Stopping the drive

Stopping the drive up to standstill of the drive can be parameterized via various time constants. The parameterized *Stopping behavior* **630** as a function of the digital signals *Start clockwise* **STR** and *Start Anti-clockwise* **STL** is to be observed.

1. If the internal reference frequency (output of the ramp function) is smaller than the *Frequency threshold* **809** (time T_c), the sequence of the shutdown function starts. The percentage is set relative to the *Maximum frequency* **419**.
2. After *Time t13* **806** the signal of the holding brake is deactivated. To reduce wear and tear, this time should be set in such a way that the drive is at a standstill before the brake closes. If the signal is to be deactivated when the drive is still rotating, this time is to be set to zero and the *Frequency threshold* **809** increased if need be. A long reaction time of the mechanical brake in closing can thus be compensated.
3. After expiry of *Time t12* **805** the current monitoring is deactivated. This time constant should be at least equal to the reaction time of the mechanical brake in closing.
4. After expiry of *Time t11* **804** the power parts of the frequency inverter are blocked. The current in the motor goes to zero.
5. After expiry of *Time t15* **807** the signal to close the safety switch is deactivated. As the deceleration time of a relay is normally distinctly longer than the time needed for the current reduction, this time can remain at the figure zero (factory setting) in most cases.

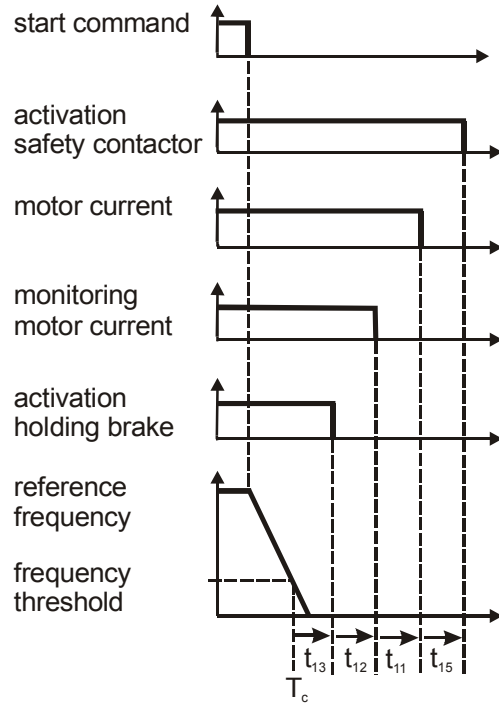

4.2.5 Interrupting the start or stop process

If the start command is deactivated again before the start sequence has been completed, the last step of the start sequence is canceled again immediately. After this, the sequence for stopping commences, starting with this condition.

Example:

If the start command is deactivated (current monitoring is active, waiting for the release of the brake) during the expiry of time t_3 , the minimum current monitoring is deactivated straight away. After expiry of time t_{11} the power parts are blocked.

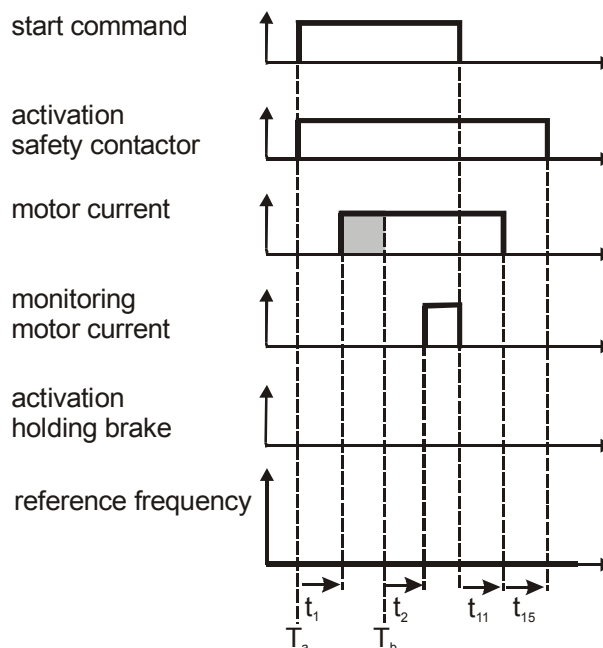

If a new start command is given before the sequence for stopping has ended, the last step of the sequence is canceled immediately. The described start sequence then commences, starting with this condition.

4.2.6 Occurrence of a malfunction

If the frequency inverter switches off due to a malfunction, the signals to release the brake and close the safety switch are deactivated immediately. After acknowledgment of the malfunction, the drive can be started again. The same steps take place as in the start process.

5 Load detection for hoist application and luffing jib cranes

The present documentation supplements the operating instructions for applications with an extended activation of a holding brake and the function for automatic load detection in hoist application and luffing jib cranes.

The application manual documents the additional functionality of the frequency inverters in the software configurations 160, 260 and 460. These configurations supplement the configurations 110, 210 and 410, which are described in detail in the operating instructions.

5.1 Load detection for hoist application

The function for load detection for hoist application is activated by the parameter *Operation mode LS* **822**. In the factory setting, the Load Estimate (LE) operating mode is set to zero, i.e. switched off. To activate the load detection for hoist application, operation mode 1 or 3 must be selected.

Operation mode	Function
1 - Load estimate hoist application	The permitted maximum frequency will be adjusted by the detected load and the <i>Current Limit</i> 818 . The current after the acceleration will be observed.
2 - Load estimate luffing jib crane	Like 1 to start with. Then modification of the permitted maximum frequency, with the result that the adjustable maximum torque-forming reference currents of the parameters 819, 820 and 821 are complied with.
3 - Load estimate hoist application	The permitted maximum frequency will be adjusted by the detected load and the <i>Current Limit</i> 818 . The current during the acceleration will be observed.
4 - Load estimate luffing jib crane	Like 3 to start with. Then modification of the permitted maximum frequency, with the result that the adjustable maximum torque-forming reference currents of the parameters 819, 820 and 821 are complied with.

For the load estimate, the *Mechanical time constant* **811** and the system constant *Turns per meter* **812** must be known. With the help of these parameter figures, the load estimate calculates the load in the lifting application during the acceleration. It is related to the rated torque of the machine and displayed by the actual figure *Estimated load* **243**.

In the basic speed area, the current load or torque relative to the rated torque is additionally displayed with the actual figure *Load* **242**. The permitted maximum speed is determined from the estimated load.

The maximum speed can be scaled via two parameters.

- **Parameter *I limit* 818**
Current with which the load detection calculates the permitted maximum speed.
- **Parameter *Pull-out torque at Fmax* 816**
The pull-out torque relative to the rated torque of the asynchronous machine admissible at the maximum frequency.

5.1.1 Mechanical time constant

The *mechanical time constant* **811** is the time which the drive needs to accelerate from a standstill to rated speed with rated current.

Neglecting the friction,

$$T = J \cdot \frac{d\omega}{dt}$$

T is the rated torque of the machine, J the entire mass moment of inertia of the drive.

$$dt = J \cdot \frac{d\omega}{T}$$

$$\frac{n}{60} \cdot 2 \cdot \pi = \omega$$

n is the no load speed of the machine, thus resulting in the mechanical time constant t_m :

$$t_m = \frac{J \cdot n \cdot 2 \cdot \pi}{T \cdot 60}$$

If the entire mass moment of inertia J is not exactly known, the mechanical time constant t_m can also be determined by an acceleration test.

For this, the plant constant *Turns per meter* **812** must be set first. After this, the lifting application is to be run without load at a constant speed (half rated speed of the machine) (clockwise, lifting).

The actual value *Load* **242** is noted.

Now, the lifting application is accelerated from standstill with the *Acceleration (clockwise)* **420** required in operation to a speed above the rated speed of the machine (clockwise, lifting). Now, the actual value *Estimated load* **243** is evaluated.

If the value displayed for the estimated load is larger than the figure established before, the parameter value *mechanical time constant* **811** must be increased. In the opposite case, this figure must be reduced.

Parameter		Setting		
No.	Description	Min.	Max.	Fact. sett.
811	Mech. time constant	0.000 s	65.000 s	0.190 s

5.1.2 Turns per meter

The number of mechanical turns of the motor per meter of lifting (Δh) must be input in lifting applications via the parameter *Turns/m* **812**.

For load estimation in a luffing jib crane, the number of mechanical turns of the motor for the alteration of length (Δl) of one meter of rope for the luffing jib must be input. In this, the step-down of the pulley must also be taken into account.

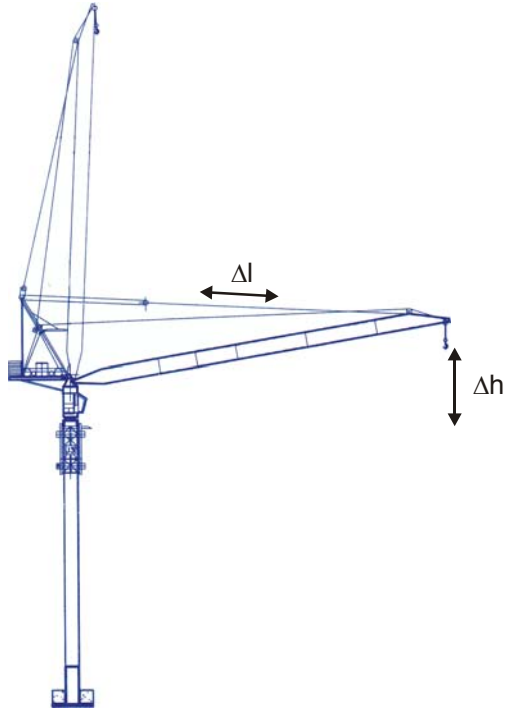

Parameter		Setting		
No.	Description	Min.	Max.	Fact. sett.
812	Turns/m	0.01 U/m	650.00 U/m	20.00 U/m

5.1.3 Load estimate

The load estimate is done in the basic speed area. In order to avoid faults at a stand-still and very low speeds, the load estimate is only done above a rotary frequency limit, which can be set with the parameter *Fm lower value LE* **813**. The value is input in per cent and is relative to the rated frequency of the machine.

Parameter		Setting		
No.	Description	Min.	Max.	Fact. sett.
813	Fm lower value LE	0 %	100 %	10 %

The load estimate starts above the rotary frequency given by the parameter *Fm lower value LS* **813**. The maximum time of the load estimate can be set with the parameter *Max Time LE* **815**. If the set time has been exceeded or if the basic speed area is left, the determined *Load* **243** is displayed. From it, the maximum admissible speed is calculated.

Parameter		Setting		
No.	Description	Min.	Max.	Fact. sett.
815	Max time LE	0.001 s	65.000 s	2.000 s

With a constant stator current, the torque of the asynchronous machine is constant in the basic speed area. Above it, it drops at $1/x$, the output power remains constant. The pull-out torque (T_{break}) drops by $1/x^2$ in the field-weakening area. With the required stator current (Parameter *I limit* **818**) the permitted rotary frequency is calculated from the P_{const} characteristic. In addition, the limitation of the maximum speed can be done with the pull-out torque, for which purpose a percentage relative to the rated torque is entered in parameter *Pull-out torque at Fmax* **816**, this torque being permitted at the *Maximum Frequency* **419**.

The permitted maximum speed is calculated in such a way that the characteristic given by the Parameter *Pull-out torque at Fmax* **816** is not exceeded.

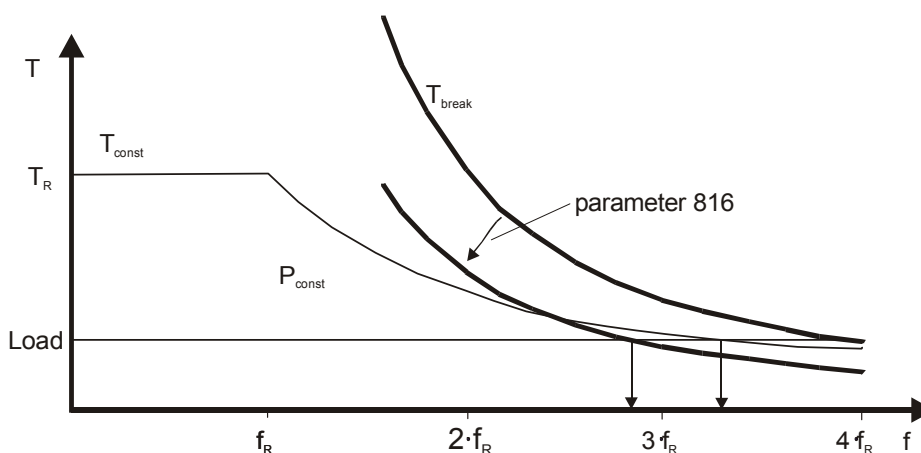

Parameter		Setting		
No.	Description	Min.	Max.	Fact. sett.
816	Pull-out torque at Fmax	0 %	100 %	100 %

If the parameter *Operation mode LE* **822** is set to 1 or 2, the stationary end figure at the maximum frequency then allowed is used for the calculation.

If the parameter *Operation mode LE* **822** is set to 3 or 4, the additional torque for the acceleration is taken into account. As the deceleration is regarded as being particularly critical, the set *Deceleration Anti-clockwise* **423** is evaluated here.

5.1.4 Speed switch-off limit

As an additional security element in the lowering of a load, a further monitoring has been implemented. The reference value of the speed is compared with the actual value of the speed. If the absolute value of the speed is larger than the actual speed by the value entered in the parameter *Speed switch-off limit 817*, the fault "F1110 overspeed" is triggered.

If the direction of rotation deviates from the nominal direction, the fault is output as soon as the absolute value of the speed exceeds the adjustable threshold.

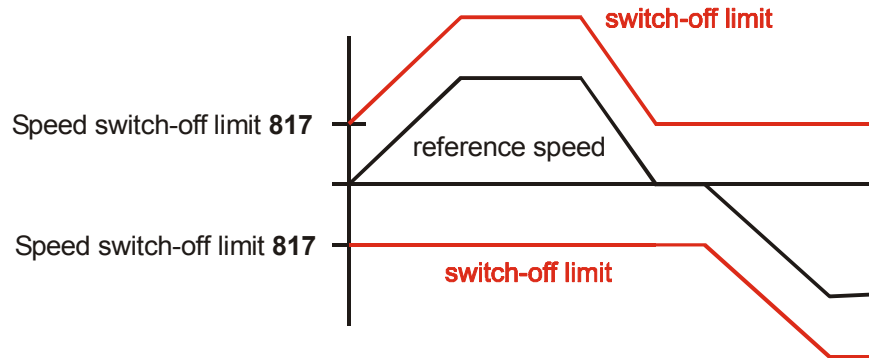

Parameter		Setting		
No.	Description	Min.	Max.	Fact. sett.
817	Speed switch-off limit	0.00 Hz	999.99 Hz	10.00 Hz

With the *I limit* parameter, the maximum permitted speed at the detected load is scaled.

- If the parameter *I limit 818* is enlarged, a larger maximum speed is permitted at the same load.
- If the *I limit 818* is reduced, the maximum speed is reduced accordingly. As a minimum, the rated speed is permitted.

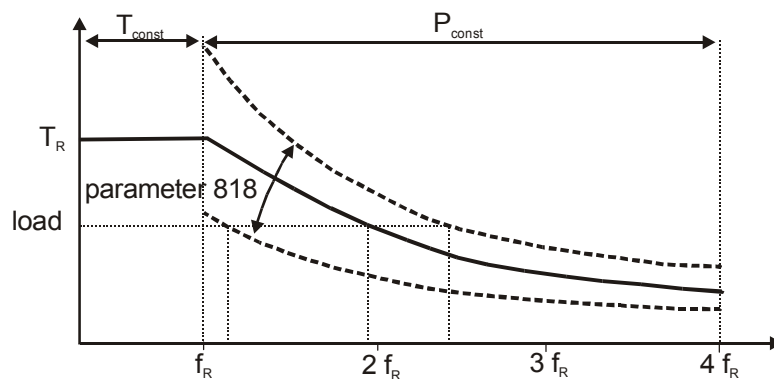

Parameter		Setting		
No.	Description	Min.	Max.	Fact. sett.
818	<i>I limit</i>	$0.01 \cdot I_{FIN}$	$3 \cdot 0 \cdot I_{FIN}$	I_{FIN}

If the parameter *Operation mode LE 822* has been set to 1 or 2, the limit is the effective value of the stator current which sets after the acceleration at the permitted maximum speed.

The torque-forming current available in the acceleration phase is a function of the rated current and the torque of the asynchronous machine resulting from it.

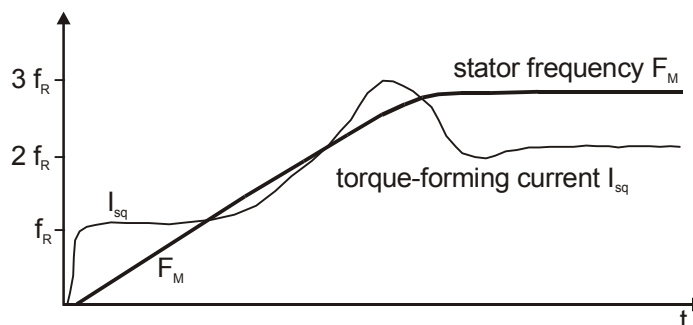

If the parameter *Operation mode LE 822* is set to 3 or 4, the additional current for the acceleration is taken into account. In this, the limit current is the effective value of the stator current which can be set for a short time during the set maximum acceleration. As the deceleration is regarded as being particularly critical, the set *Deceleration Anti-clockwise 423* is taken into account here.

5.2 Load detection for luffing jib cranes

The function for load detection for hoist applications activated by the parameter *Operation mode LS 822*. In the factory setting, the Load Estimate (LE) operating mode is set to zero, i.e. switched off. To activate the load detection for hoist application, operation mode 1 or 3 must be selected.

Operation mode	Function
1 - Load estimate hoist application	The permitted maximum frequency will be adjusted by the detected load and the <i>Current Limit 818</i> . The current after the acceleration will be observed.
2 - Load estimate luffing jib crane	Like 1 to start with. Then modification of the permitted maximum frequency, with the result that the adjustable maximum torque-forming reference currents of the parameters 819, 820 and 821 are complied with.
3 - Load estimate hoist application	The permitted maximum frequency will be adjusted by the detected load and the <i>Current Limit 818</i> . The current during the acceleration will be observed.
4 - Load estimate luffing jib	Like 3 to start with. Then modification of the permitted maximum frequency, with the result that the adjustable maximum torque-forming reference currents of the parameters 819, 820 and 821 are complied with.

For the load estimate, the *Mechanical time constant 811* and the system constant *Turns per meter 812* must be known. With the help of these parameter figures, the load estimate calculates the sum of the loads in the lifting application (load of the luffing jib and load on the hook) during the acceleration. They are related to the rated torque of the machine and displayed as a percentage by the actual value *Load Estimate 243*.

In the basic speed area, the current load and the torque relative to the rated torque are additionally displayed by the actual figure *Load 242*. The permitted maximum speed is determined from the estimated load.

The maximum speed can be scaled via two parameters.

- **Parameter *I limit* 818**
Current with which the load detection calculates the permitted maximum speed.
- **Parameter *Pull-out torque at Fmax* 816**
The pull-out torque relative to the rated torque of the asynchronous machine admissible at the maximum frequency.

After this, the permitted maximum speed is modified as a function of the position of the luffing jib.

The parameters *Mech. time constant* **811**, *Turns/m* **812**, *Fm lower value LE* **813**, *Max time LE* **815**, *Pull-out torque at Fmax* **816**, *Speed switch-off limit* **817** and *I limit* **818** are parameterized in a way comparable with the described settings for the load detection for the lifting crane.

In a crane with a luffing jib, the torque acting on the motor changes with the angle of the luffing jib. In order not to overload the motor in the field weakening area, the maximum permitted speed of the motor must therefore be adapted as a function of the angle of the luffing jib.

These settings for the luffing jib are to be done via the parameters described below: *Desired Isq up* **819**, *Desired Isq down at FsR* **820** and *Desired Isq down at Fmax* **821**.

5.2.1 Torque-forming current I_{sq}

The maximum permitted speed during the lifting of the luffing jib is changed in such a way that the torque-forming current I_{sq} corresponds to the figure set with parameter *Desired Isq up* **819** in the field weakening area. The permitted maximum speed is a function of the angle of the luffing jib.

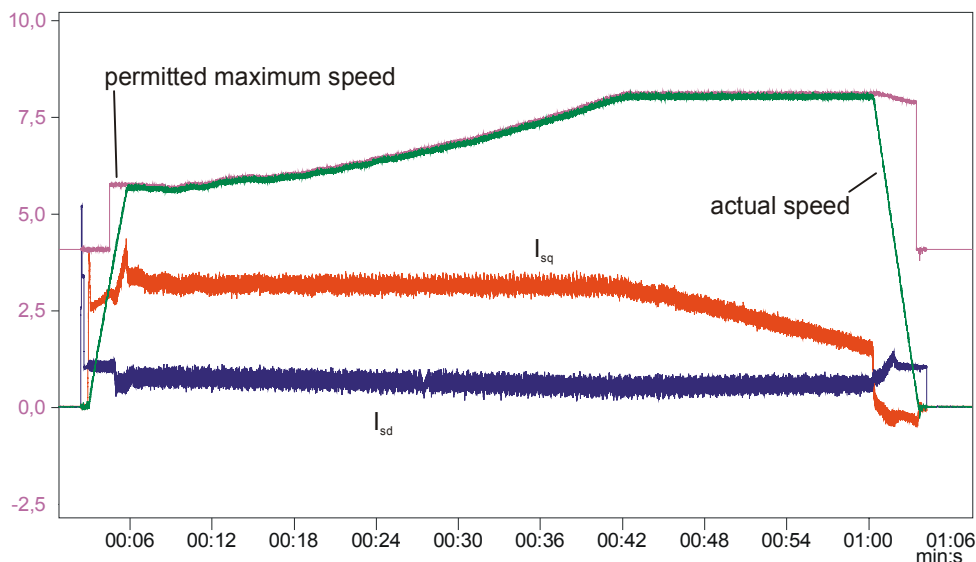

The rise of the torque-forming current I_{sq} at the 6 s point in time is needed for the acceleration.

If the value *Desired Isq up* **819** is increased, the absolute current value and the maximum permitted speed for the lifting of the luffing jib increase. If the value *Desired Isq up* **819** is reduced, both are reduced accordingly.

The effective value of the current is composed of the vector addition of I_{sq} and I_{sd} . If the effective value of the current is to be equal to the rated current during the lifting in stationary operation, the value in parameter 819 must be input some percent smaller than the rated current.

Parameter		Setting		
No.	Description	Min.	Max.	Fact. sett.
819	Desired Isq up	$0.01 \cdot I_{FIN}$	$0 \cdot I_{FIN}$	$0.8 \cdot I_{FIN}$

During the lowering of the luffing jib, the machine works as a generator. Thanks to the properties of the machine, the frequency inverter and the mechanics, the effective value of the current is distinctly lower than in lifting, in particular in the field weakening area, with the same speed and load. If the speed is additionally increased, this leads to a further reduction of the current.

Two further parameters, with which the reference value for the torque-forming current I_{sq} is stated in the lowering of the luffing jib arm, have been created for these operation points for the synchronization of the permitted maximum speed.

With the parameter *Desired I_{sq} down at F_{sR}* **820** the current is specified in the operation points with rated frequency.

With the parameter *Desired I_{sq} down at F_{max}* **821** the current at the frequency limit set with the parameter *Maximum Frequency* **419** is specified.

The reference value used for the calculation is subjected to linear interpolation within these frequency limits.

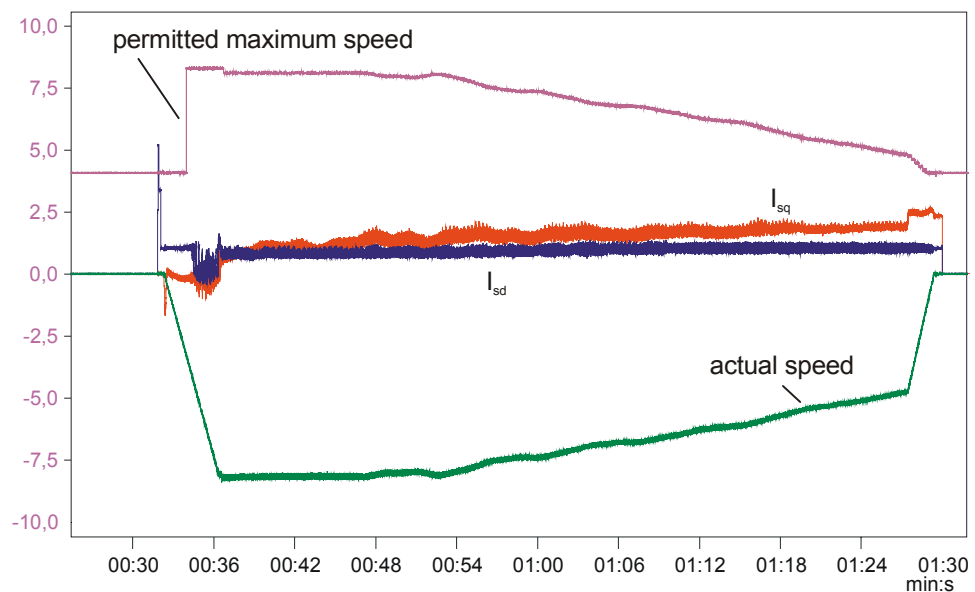

The permitted maximum speed is displayed in the above illustration with the negative speed in an anti-clockwise direction.

It can clearly be seen that the torque-forming current increases as the absolute value of the speed decreases.

Parameter		Setting		
No.	Description	Min.	Max.	Fact. sett.
820	Desired I_{sq} down at F_{sR}	$0.01 \cdot I_{FIN}$	$0 \cdot I_{FIN}$	$0.80 \cdot I_{FIN}$
821	Desired I_{sq} down at F_{max}	$0.01 \cdot I_{FIN}$	$0 \cdot I_{FIN}$	$0.55 \cdot I_{FIN}$

5.3 Limitation of the speed by fixed frequencies

The maximum permitted speed can be limited by the parameters *Fixed Frequency 1 480*, *Fixed Frequency 2 481*, *Fixed Frequency 3 482* and *Fixed Frequency 3 483*. For this, the parameter *Frequency upper limit source 769* is to be set to the operation mode 110.

If the additional limitation has been activated, the maximum frequency (maybe permitted by the load detection or its modification during the movement of a luffing jib) is limited to the current fixed frequency. The limitation is effective for both clockwise and anti-clockwise.

Operation mode	Function
0 - Off	There is no additional speed limitation
110 - Fixed limit	The selected fixed frequencies are taken into account for limitation

5.4 Temperature adjustment

The properties of the asynchronous machine change with the temperature and can be taken into account via a suitable measurement or estimate. Various methods and sources of actual values for temperature detection are to be selected via the parameter *Operation mode Temperature adjustment 465*.

The parameter *Operation mode Temperature adjustment 465* is pre-set to the operation mode 4-temperature estimate in the configurations 260 and 460. In switching on, the temperature of the asynchronous machine is estimated and taken into account for correct calculation.

If this is not required, the parameter *Operation mode Temperature adjustment 465* must be parameterized to the operation mode 0-Off.



Operation mode	Function
0 - Off	The function is deactivated
1 - Temp. Detect. At AE1	Temperature synchronization (0 ... 200°C => 0/2 ... 10V), actual temperature value to multifunctional input 1
2 - Temp. Detect. At AE2	Temperature synchronization (0 ... 200°C => 0/2 ... 10V), actual temperature value to multifunctional input 2
3 - Temp. Detect. At AE3	Temperature synchronization (0 ... 200°C => 0/2 ... 10V), actual temperature value to multifunctional input 3
4 - Temperature estimate	Temperature synchronization by estimation
11 to 13	Operation modes 1 to 3 with the VECTRON extension temperature synchronization (-26.0 ... 207.8°C => 0 ... 10V)

The *Adjusting temperature 467* is to be set to the temperature at which the optimization of the extended machine data has been carried out. The temperature can be read out via the actual value parameter *Winding temperature 226* and can be used in the optimization for the parameter.

Parameter		Setting		
No.	Description	Min.	Max.	Fact. sett.
467	Adjusting temperature	-50.0 °C	300.0 °C	100.0 °C

6 Parameter list

























The parameter list is structured according to the menu branches of the operating unit. For better clarity, the parameters have been marked with pictograms:

-  The parameter is available in the four data sets
-  The parameter value is set by the SET-UP routine
-  This parameter cannot be written in the operation of the frequency inverter.

6.1 Actual value menu (VAL)

Actual values of the system				
No.	Description	Unit	Display range	Chapter
242	Load	%	0.0 ... 999.9	5.1
243	Estimated load	%	0.0 ... 999.9	5.1

6.2 Parameter menu (PARA)

Temperature adjustment					
No.	Description	Unit	Display range	Chapter	
	465	Operation mode	-	Selection	5.4
	467	Adjusting temperature	°C	-50.0 ... 300.0	5.4
Speed controller					
	769	Frequency Upper Limit Source	-	Selection	5.3
Brake control					
	800	Time t1	s	0.0 ... 20.0	4.2
	801	Time t2	s	0.0 ... 20.0	4.2
	802	Time t3	s	0.0 ... 20.0	4.2
	803	Time t4	s	0.0 ... 20.0	4.2
	804	Time t11	s	0.0 ... 20.0	4.2
	805	Time t12	s	0.0 ... 20.0	4.2
	806	Time t13	s	0.0 ... 20.0	4.2
	807	Time t15	s	0.0 ... 20.0	4.2
	808	Monitoring current	A	0.0 ... $0 \cdot I_{FIN}$	4.2.1
	809	Frequency threshold	%	0.0 ... 100.0	4.2.2
Load estimation					
	811	Mech. time constant	s	0.000 ... 65.000	5.1.1
	812	Turn/m	U/m	0.01 ... 650.00	5.1.2
	813	Fm lower value LE	%	0 ... 100	5.1.3
	815	Max time LE	s	0.001 ... 65.000	5.1.3
	816	Pull-out torque at Fmax	%	0 ... 100	5.1.3
	817	Speed switch-off Limit	Hz	0.00 ... 999.99	5.1.3
	818	I limit	A	$0.01 \cdot I_{FIN}$... $3 \cdot 0 \cdot I_{FIN}$	5.1.3
	819	Desired Isq up	A	$0.01 \cdot I_{FIN}$... $0 \cdot I_{FIN}$	5.2.1
	820	Desired Isq down at FsR	A	$0.01 \cdot I_{FIN}$... $0 \cdot I_{FIN}$	5.2.1
	821	Desired Isq down at Fmax	A	$0.01 \cdot I_{FIN}$... $0 \cdot I_{FIN}$	5.2.1
	822	Operation mode LE	-	Selection	5.1



Bonfiglioli has been designing and developing innovative and reliable power transmission and control solutions for industry, mobile machinery and renewable energy applications since 1956.

www.bonfiglioli.com

Bonfiglioli Riduttori S.p.A.
Via Giovanni XXIII, 7/A
40012 Lippo di Calderara di Reno
Bologna, Italy

tel: +39 051 647 3111
fax: +39 051 647 3126
bonfiglioli@bonfiglioli.com
www.bonfiglioli.com

VEC 557 R0