

ACTIVE and ACTIVE Cube

Expansion Module EM-IO-03
Frequency Inverter 230V / 400V



General points on the documentation

The present supplement of the documentation is valid for the frequency inverter series ACT and ACU. The information necessary for the assembly and application of the EM-IO-03 expansion module is documented in this guidance.

For better clarity, the user documentation is structured according to the customer-specific demands made of the frequency inverter.

Brief instructions

The brief instructions describe the fundamental steps for mechanical and electrical installation of the frequency inverter. The guided commissioning supports you in the selection of necessary parameters and the software configuration of the frequency inverter.

Operating instructions

The operating instructions document the complete functionality of the frequency inverter. The parameters necessary for specific applications for adaptation to the application and the extensive additional functions are described in detail.

Application manual

The application manual supplements the documentation for purposeful installation and commissioning of the frequency inverter. Information on various subjects connected with the use of the frequency inverter is described specific to the application.

Installation Instructions

Complementing the Brief Instructions and the Operating Instructions, the Installation Instructions provide information on how to install and use the additional/optional components.

The documentation and additional information can be requested via your local representation of the company of BONFIGLIOLI.

The following pictograms and signal words are used for the purposes of the present documentation:



Danger!

means a directly threatening danger. Death, serious damage to persons and considerable damage to property will occur if the precautionary measure is not taken.



Warning!

marks a possible threat. Death, serious damage to persons and considerable damage to property can be the consequence if attention is not paid to the text.



Caution!

refers to an indirect threat. Damage to people or property can be the result.

Attention!

refers to a possible operational behavior or an undesired condition, which can occur in accordance with the reference text.

Note

marks information, which facilitates handling for you and supplements the corresponding part of the documentation.



Warning! In installation and commissioning, comply with the information in the documentation. You as a qualified person must have read the documentation carefully and understood it. Comply with the safety instructions. For the purposes of the instructions, "qualified person" designates a person acquainted with the erection, assembly, commissioning and operation of the frequency inverters and possessing the qualification corresponding to the activity.

TABLE OF CONTENTS

General points on the documentation	1
1 General safety and application information	5
1.1 General information.....	5
1.2 Proper use.....	5
1.3 Transport and storage	6
1.4 Handling and positioning.....	6
1.5 Electrical connection.....	6
1.6 Operation information	6
1.7 Maintenance and service	6
2 Introduction	7
3 Installation of the EM-IO-03 expansion module	8
3.1 General	8
3.2 Mechanical installation.....	8
3.3 Electrical installation	10
3.3.1 Circuit diagram	10
3.3.2 Control terminals	11
4 System bus interface.....	12
4.1 Bus termination	12
4.2 Cables	13
4.3 Socket X410B.....	13
4.4 Baud rate setting/line length	14
4.5 Setting node address.....	14
4.6 Functional overview	15
4.7 Network management.....	15
4.7.1 SDO channels (parameter data)	16
4.7.2 PDO channels (process data)	17
4.8 Master functionality.....	18
4.8.1 Control boot-up sequence, network management.....	18
4.8.2 SYNC telegram, generation.....	20
4.8.3 Emergency message, reaction.....	21
4.8.4 Client SDO (system bus master).....	22
4.9 Slave functionality	23
4.9.1 Implement boot-up sequence, network management.....	23
4.9.1.1 Boot-up message	23
4.9.1.2 Status control	23
4.9.2 Process SYNC telegram	24
4.9.3 Emergency message, fault switch-off.....	25
4.9.4 Server SDO1/SDO2.....	26

TABLE OF CONTENTS

4.10	Communication channels, SDO1/SDO2	28
4.10.1	SDO telegrams (SDO1/SDO2)	28
4.10.2	Communication via field bus connection (SDO1).....	30
4.10.2.1	Profibus-DP	30
4.10.2.2	RS232/RS485 with VECTRON bus protocol	30
4.11	Process data channels, PDO	32
4.11.1	Identifier assignment process data channel.....	32
4.11.2	Operation modes process data channel.....	33
4.11.3	Timeout monitoring process data channel.....	34
4.11.4	Communication relationships of the process data channel	35
4.11.5	Virtual links	36
4.11.5.1	Input parameters of the TxPDO's for data to be transmitted	39
4.11.5.2	Source numbers of the RxPDO's for received data.....	41
4.11.5.3	Examples of virtual links	42
4.12	Control parameters	43
4.13	Handling of the parameters of the system bus	44
4.14	Utilities	46
4.14.1	Definition of the communication relationships.....	47
4.14.2	Production of the virtual links.....	48
4.14.3	Capacity planning of the system bus.....	49
5	Control inputs and outputs	51
5.1	Analog input EM-S1INA	51
5.1.1	General.....	51
5.1.2	Configuration voltage/current input.....	51
5.1.3	Characteristic	52
5.1.4	Operation modes	52
5.1.4.1	Examples.....	53
5.1.5	Scaling.....	55
5.1.6	Tolerance band and hysteresis.....	56
5.1.7	Error and warning behavior	57
5.1.8	Adjustment	58
5.1.9	Filter time constant.....	58
5.2	Analog output EM- S1OUTA (voltage output)	59
5.2.1	General.....	59
5.2.2	Operation modes	59
5.2.3	Adjustment	59
5.2.4	Zero adjustment and amplification	60
5.2.4.1	Examples.....	60
5.3	Analog output EM- S2OUTA (current output)	61
5.3.1	General.....	61
5.3.2	Operation modes	61
5.3.3	Adjustment	61
5.3.4	Zero adjustment and amplification	62
5.3.4.1	Examples.....	62
5.4	Digital output EM-S1OUTD	63
5.4.1	General.....	63
5.4.2	Operation modes	63

TABLE OF CONTENTS

5.5	Digital inputs EMS2IND and EMS3IND	63
5.5.1	Fixed reference values and fixed value switch-over.....	63
5.6	Digital inputs for speed sensor 2	64
5.6.1	Division marks speed sensor 2.....	64
5.6.2	Actual speed source.....	65
5.6.3	Actual value comparison.....	65
5.7	Frequency and percentage reference channel	66
5.8	Actual value display	66
5.9	Status of the digital signals	67
5.10	Motor temperature	68
6	Parameter list	70
6.1	Actual value menu (VAL).....	70
6.2	Parameter menu (PARA).....	70
7	Annex	73
7.1	Error messages.....	73

1 General safety and application information

This documentation has been created with greatest care and has been extensively and repeatedly checked. For reasons of clarity, we have not been able to take all detailed information on all the types of the products and also not every imaginable case of positioning, operation or maintenance into account. If you require further information or if particular problems not treated extensively enough in the operating instructions occur, you can obtain the necessary information via the local representation of the company BONFIGLIOLI.

In addition, we would point out that the contents of these operating instructions are not part of an earlier or existing agreement, assurance or legal relationship, nor are they intended to amend them. All the manufacturer's obligations result from the purchase contract in question, which also contains the completely and solely valid warranty regulation. These contractual warranty provisions are neither extended nor limited by the implementation of these operating instructions.

The manufacturer reserves the right to correct or amend the contents and product information as well as omissions without specific announcement and assumes no kind of liability for damage, injuries or expenditure to be put down to the aforementioned reasons.

1.1 General information



Warning! BONFIGLIOLI VECTRON frequency inverters have high voltage levels during operating, depending on their protection class, drive moving parts and have hot surfaces.

In the event of inadmissible removal of the necessary covers, improper use, wrong installation or operation, there is the risk of serious damage to persons or property.

To avoid the damage, only qualified staff may carry out the transport, installation, setup or maintenance work required. Comply with the standards EN 50178, IEC 60364 (Cenelec HD 384 or DIN VDE 0100), IEC 60664-1 (Cenelec HD 625 or VDE 0110-1), BGV A2 (VBG 4) and national provisions. Qualified persons within the meaning of this principal safety information are people acquainted with the erection, fitting, commissioning and operating of frequency inverters and the possible hazards and in possession of qualifications matching their activities.

1.2 Proper use



Warning! The frequency inverters are electrical drive components intended for installation in industrial plant or machines. Commissioning and start of intended operation are not allowed until it has been established that the machine corresponds to the provisions of the EC machine directive 98/37/EEC and EN 60204. According to the CE sign, the frequency inverters additionally fulfill the requirements of the low-voltage directive 73/23/EEC and the standards EN 50178 / DIN VDE 0160 and EN 61800-2. Responsibility for compliance with the EMC directive 89/336/EEC is with the user. Frequency inverters are available in a limited way and as components exclusively intended for professional use within the meaning of the standard EN 61000-3-2.

With the issue of the UL certificate according to UL508c, the requirements of the CSA Standard C22.2-No. 14-95 have also been fulfilled.

The technical data and the information on connection and ambient conditions stated on the rating plate and the documentation must be complied with. The instructions must have been read and understood before starting work at the device.

1.3 Transport and storage

Transport and storage are to be done appropriate in the original packing. Store the units only in dry rooms, which are protected against dust and moisture and are subjected to little temperature deviations only. Observe the climatic conditions according to standard EN 50178 and to the information on the label of the original packing. The duration of storage without connection to the admissible reference voltage may not exceed one year.

1.4 Handling and positioning



Warning! Damaged or destroyed components may not be put into operation because they may be a health hazard.

The frequency inverters are to be used according to the documentation, the directives and the standards. Handle carefully and avoid mechanical overload. Do not bend the components or change the isolation distances. Do not touch electronic components or contacts. The devices contain construction elements with a risk of electrostatic, which can easily be damaged by improper handling. Any use of damaged or destroyed components shall be considered as a non-compliance with the applicable standards. Do not remove any warning signs from the device.

1.5 Electrical connection



Warning! Before any assembly or connection work, de-energize the frequency inverter.

Do not touch the sockets, because the capacitors may still be charged.

Make sure that the frequency inverter is de-energized.

Comply with the information given in the operating instructions and on the frequency inverter label.

While working on the frequency inverters, obey the applicable standards BGV A2 (VBG 4), VDE 0100 and other national directives. Comply with the information in the documentation on electrical installation and the relevant directives. Responsibility for compliance with and examination of the limit values of the EMC product standard EN 61800-3 for variable-speed electrical drive mechanisms is with the manufacturer of the industrial plant or machine.

The documentation contains information on installation correct for EMC. The cables connected to the frequency inverters may not be subjected to an isolation test with a high test voltage without previous circuit measures.

1.6 Operation information



Warning! Before commissioning and the start of the intended operation, attach all the covers and check the sockets. Check additional monitoring and protective devices pursuant to EN 60204 and the safety directives applicable in each case (e.g. Working Machines Act, Accident Prevention Directives etc.).

No connection work may be performed, while the system is in operation.

1.7 Maintenance and service



Warning! Unauthorized opening and improper interventions can lead to physical injury or damage to property. Repairs on the frequency inverters may only be done by the manufacturer or persons authorized by the latter.

2 Introduction

This document describes the possibilities and the properties of the EM-IO-03 expansion module for the frequency inverters of the ACT and ACU series of devices.

Note: This document exclusively describes the EM-IO-03 expansion module. It does not provide basic information on the operation of the ACT and ACU series frequency inverters.

The EM-IO-03 expansion module is an optional hardware component to extend the functionality of the frequency inverter. It enables the data exchange within the network and between the components which have been directly connected, for example control elements.

The EM-IO-03 expansion module is supported from device series ACU and as from software version 4.1.0 of device series ACT.

The module extends the functionality of the frequency inverters of the ACT and ACU series of devices by the following additional functions:

- **CAN system bus**
(CAN interface ISO-DIS 11898; CAN High Speed; max. 1 Mbaud)
- **analog input, adjustable voltage/current input**
(second bipolar analog input)
- **two analog outputs: one voltage output and one current output**
(second and third bipolar analog output)
- **two digital inputs**
(can be used as second incremental speed sensor input, for example)
- **one relay output**
(make contacts)
- **one motor PTC connection**

The EM-IO-03 expansion module has been enclosed with the frequency inverter as a separate component and must be fitted by the user. This is described in detail in the "Mechanical Installation" chapter.

The expansion module is assembled simply by plugging on without tools being needed thanks to the modular set-up of the frequency inverters of the ACT and ACU series.



Warning! The assembly is done before the frequency inverter is put into operation, and only in a voltage-free state.

The terminals of the expansion module, which are also to be plugged, enable economical overall fitting with a safe function.

3 Installation of the EM-IO-03 expansion module

3.1 General

The mechanical and electrical installation of the EM-IO-03 expansion module is to be carried out by qualified personnel according to the general and regional safety and installation directives. Safe operation of the frequency inverter presupposes that the documentation and the device specification are complied with in installation and start of operation. If specific areas of application exist, further provisions and guidelines must possibly be complied with.

The frequency inverters are designed according to the requirements and limit values of product standard EN 61800-3 with an interference immunity factor (EMI) for operation in industrial applications. The electromagnetic interference is to be avoided by expert installation and observation of the specific product information.

For further information, refer to the chapter "Electrical Installation" of the frequency inverter operating instructions.



Warning! All connection terminals where dangerous voltage levels may be present (e.g. motor connection terminals, mains terminals, fuse connection terminals, etc.), must be protected against direct contact.

3.2 Mechanical installation



Danger! If the following instructions are not complied with, there is direct danger with the possible consequences of death or severe injury by electrical current. Further, failure to comply can cause the destruction of the frequency inverter and/or of the expansion module.

- Before assembly or disassembly of the EM-IO-03 expansion module, the frequency inverter must be de-energized. Take appropriate measures to make sure it is not energized unintentionally.
- Make sure that the frequency inverter is de-energized.



Danger! The mains, direct voltage and motor terminals can be live with dangerous voltage after disconnection of the frequency inverter. Work may only be done on the device after a waiting period of some minutes until the DC link capacitors have discharged.

The EM-IO-03 expansion module is supplied in a housing for assembly on the lower slot of the frequency inverter.

- Remove the lower cover (1) of the frequency inverter.
The slot for the EM-IO-03 expansion module becomes accessible.

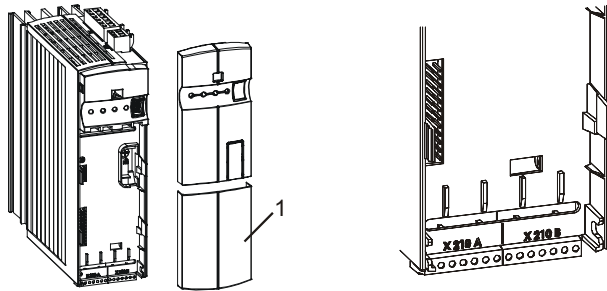

Caution! The EM-IO-03 expansion module (2) is pre-fitted in a housing. Do NOT touch the PCB visible on the back, as modules may be damaged.

- Plug the EM-IO-03 expansion module (2) onto the slot (3).

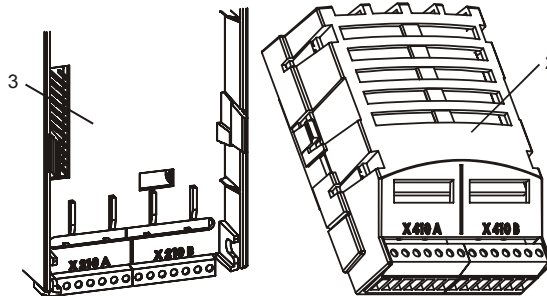

- Re-install the lower cover (1).
This completes the assembly procedure.

When the supply voltage of the frequency inverter is switched on, the EM-IO-03 expansion module is ready for operation.

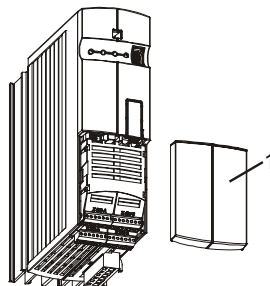

3.3 Electrical installation



Danger! If the following instructions are not complied with, there is direct danger with the possible consequences of death or severe injury by electrical current. Further, failure to comply can lead to destruction of the frequency inverter and/or of the expansion module.

- Before electrical installation of the EM-IO-03 expansion module, the frequency inverter must be de-energized. Take appropriate measures to make sure it is not energized unintentionally.
- Make sure that the frequency inverter is de-energized.



Danger! The mains, direct voltage and motor sockets can have dangerous voltages even after disconnection of the frequency inverter. Work may only be done on the device after a waiting period of some minutes until the DC link capacitors have been discharged.

3.3.1 Circuit diagram

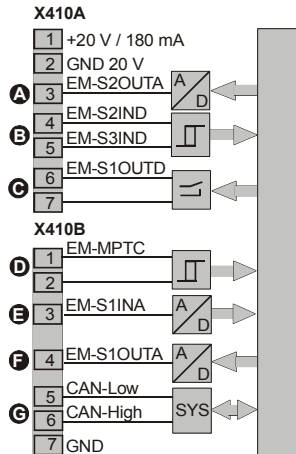

A Analog current output EM-S2OUTA

Analog signal, $I_{out} = 0(4) \dots 20$ mA, $U_{max} = 10$ V, overload and short-circuit proof

B Digital inputs EM-S2IND ... EM-S3IND

Digital signal, response time approx. 16 ms, $U_{max} = 30$ V, 10 mA at 24 V, PLC compatible, frequency signal, 0...30 V, 10 mA at 24 V, $f_{max} = 150$ kHz

C Relay connection EM-S1OUTD

Make contact, response time approx. 40 ms, 24 V AC / 1 A, 24 V DC / 1 A (ohmic)

D Motor PTC Resistor Connection EM-MPTC

Rated response resistance 2.85 k Ω (PTC) according to DIN 44081, PTC or bimetal temperature sensor (break contact)

E Analog input EM-S1INA

Analog signal, resolution 12 Bit, $U_{max} = \pm 10$ V ($R_i = 100$ k Ω), $I_{max} = \pm 20$ mA ($R_i = 250$ Ω)

F Analog voltage output EM- S1OUTA

Analog signal, $U_{max} = \pm 10$ V, $I_{max} = 2$ mA, overload and short-circuit proof

G Communication interface system bus

CAN actuation of the system bus according to ISO-DIS 11898 (CAN High Speed)



3.3.2 Control terminals

The control and software functionality can be freely configured for economical operation with a safe function.

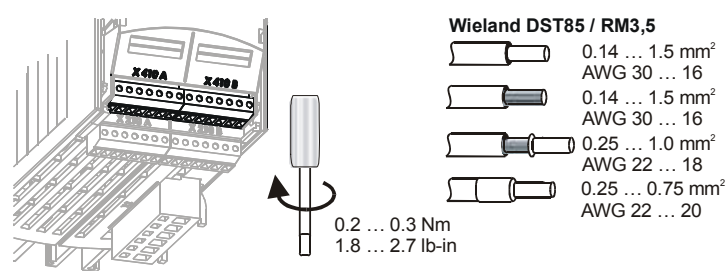
Expansion module EM-IO-03

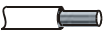

Wieland DST85 / RM3,5

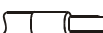
-  0.14 ... 1.5 mm²
AWG 30 ... 16
-  0.14 ... 1.5 mm²
AWG 30 ... 16
-  0.25 ... 1.0 mm²
AWG 22 ... 18
-  0.25 ... 0.75 mm²
AWG 22 ... 20

0.2 ... 0.3 Nm
1.8 ... 2.7 lb-in



Caution! The control inputs and outputs must be connected and disconnected free of electrical power. Otherwise components may be damaged.

- The unit may only be connected with the power supply switched off.
- Make sure that the frequency inverter is de-energized.

Socket X410A	
Ter.	Description
1	Voltage output 20 V, $I_{\max} = 180 \text{ mA}$ ¹⁾
2	Earth / GND 20 V
3	Analog current output EM-S2OUTA, $I_{\text{out}} = 0(4) \dots 20 \text{ mA}$, $U_{\max} = 10 \text{ V}$, overload and short-circuit proof
4	Digital input EM-S2IND, $U_{\max} = 30 \text{ V}$, 10 mA at 24 V, PLC compatible, response time approx. 16 ms
5	Digital input EM-S3IND, $U_{\max} = 30 \text{ V}$, 10 mA at 24 V, PLC compatible, response time approx. 16 ms
6-7	Digital output EM-S1OUTD, make contact, $U_{\max} = 24 \text{ V AC/DC}$, 1 A (ohmic)

Socket X410B	
Ter.	Description
1-2	Motor PTC connection EM-MPTC, rated response resistance > 2.85 k Ω (PTC) according DIN 44081
3	Analog input EM-S11NA, resolution 12 bit, $U_{\max} = \pm 10 \text{ V}$ ($R_i = 100 \text{ k}\Omega$), $I_{\max} = \pm 20 \text{ mA}$ ($R_i = 250 \Omega$)
4	Analog voltage output EM-S1OUTA, $U_{\max} = \pm 10 \text{ V}$, $I_{\max} = 2 \text{ mA}$, overload and short circuit proof
5	System bus, CAN low
6	System bus, CAN high
7	Earth / GND

¹⁾ The power supply at terminal X210A.1 may be loaded with a maximum current of $I_{\max} = 180 \text{ mA}$. Relative to the application, the maximum current available will be reduced by the further control outputs in the basic device and the expansion module.

4 System bus interface

The CAN connection of the system bus is physically designed according to **ISO-DIS 11898** (CAN High Speed). The bus topology is the line structure.

In the default version, the frequency inverter support a CAN protocol controller, which may exist in **either** the CM-CAN communication module with CANopen interface **OR** in an expansion module for the system bus, such as the EM-IO-03 expansion module.

Attention! Installation of two optional components with CAN-Protocol controller results in a deactivation of the system bus interface in the EM-IO-03 expansion module!

4.1 Bus termination

The necessary bus terminator at the physically first and last node can alternatively be activated via the two DIP switches **S1** and **S2** on the EM-IO-03 expansion module.

- Either set **S1** to ON and **S2** to OFF for a regular passive termination.
- or set **S1 and S2** to ON for an active termination. This results in an improved edge shape of the CAN signals, which causes an improvement of the signal shapes, in particular in extended systems.

Note: Switch **S3** is used to configure the analog input (see chapter "Analog input EM-S1INA").

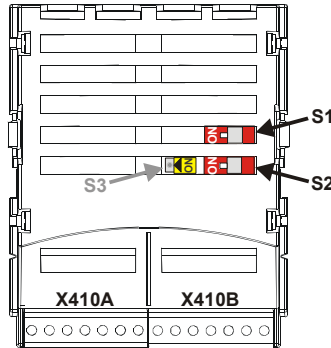

Attention! The factory setting for the bus termination is OFF.

The active termination via the DIP switches **S1** and **S2** may only be activated in **one** expansion module. The other bus termination must be passive.

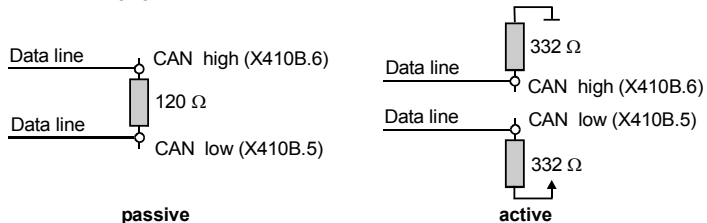

4.2 Cables

For the bus line, use twisted a cable with harness shield (**no foil shield**).

Attention! The control and communication lines are to be laid physically separate from the power lines. The harness screen of the data lines is to be connected to ground (PE) on both sides on a large area and with good conductivity.

4.3 Socket X410B

The system bus is connected via the terminals **5**, **6** and **7** of the socket **X410B** on the EM-IO-03 expansion module.

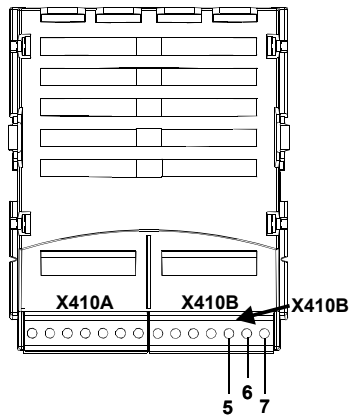

Socket X410B		
Terminals	Input/Output	Description
(5): X410B.5	CAN-Low	CAN-Low (System bus)
(6): X410B.6	CAN-High	CAN-High (System bus)
(7): X410B.7	GND	CAN-GND (System bus)

4.4 Baud rate setting/line length

The setting of the baud rate must be identical in all nodes on the system bus. The maximum possible baud rate is based on the necessary overall line length of the system bus. The baud rate is set via the parameter *Baud-Rate* **903** and thus defines the possible line length.

Operation mode	Function	max. line length
3 - 50 kBaud	Transmission rate 50 kBaud	1000 meters
4 - 100 kBaud	Transmission rate 100 kBaud	800 meters
5 - 125 kBaud	Transmission rate 125 kBaud	500 meters
6 - 250 kBaud	Transmission rate 250 kBaud	250 meters
7 - 500 kBaud	Transmission rate 500 kBaud	100 meters
8 - 1000 kBaud	Transmission rate 1000 kBaud	25 meters

A baud rate under 50 kBaud, as defined according to CANopen, is not sensible for the system bus as the data throughput is too low.

The maximum line lengths stated are guidelines. If they are made complete use of, the admissible length is to be calculated on the basis of the line parameters and the bus driver (PCA82C250T)

4.5 Setting node address

A maximum of 63 slaves or frequency inverters with system bus can be operated on the system bus. Each frequency inverter is given a node ID, which may only exist once in the system, for its unambiguous identification. The setting of the system bus node ID is done via the parameter *Node-ID* **900**.

Parameter		Setting		
No.	Description	Min.	Max.	Factory setting
900	Node-ID	-1	63	-1

Thus, the system bus possesses a maximum number of 63 nodes (Network nodes), plus one frequency inverter as a master.

Note: With the factory setting of parameter *Node-ID* **900** = -1, the system bus is deactivated for this frequency inverter.
If the *Node-ID* **900** = 0 is set, the frequency inverter is defined as a master. Only one frequency inverter on the system bus may be defined as a master.

4.6 Functional overview

The system bus produces the physical connection between the frequency inverters. Logical communication channels are produced via this physical medium. These channels are defined via the identifiers. As CAN does not possess a node-oriented, but a message-oriented addressing via the identifiers, the logical channels can be displayed via it.

In the basic state (factory setting) the identifiers are set according to the Predefined Connection Set of CANopen. These settings are aimed at one master serving all the channels. In order to be able to build up process data movement via the PDO channels between individual or a number of inverters (transverse movement), the setting of the identifiers in the nodes has to be adapted.

Note: The exchange of data is done message-oriented. An frequency inverter can transmit and receive a number of messages, identified via various identifiers.

As a special feature, the properties of the CAN bus mean that the messages transmitted by one node can be received by a number of nodes simultaneously. The error monitoring methods of the CAN bus result in the message being rejected by all recipients and automatically transmitted again if there is a faulty reception in one receiver.

4.7 Network management

The network management controls the start of all the nodes on the system bus. Nodes can be started or stopped individually or together. For node recognition in a CAL or CAN open system, the slaves on the system bus generate a starting telegram (boot-up report).

In the event of a fault, the slaves automatically transmit a fault report (emergency message).

For the functions of the network management, the methods and NMT telegrams (network management telegrams) defined according to CAN open (CiA DS 301) are used.

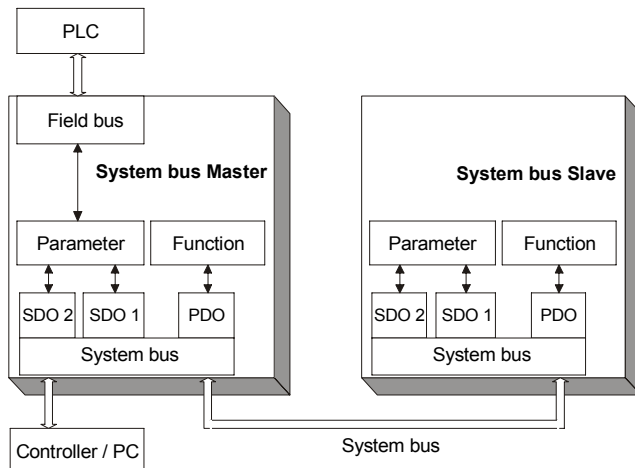

4.7.1 SDO channels (parameter data)

Each frequency inverter possesses two SDO channels for the exchange of parameter data. In a slave device, these are two server SDO's, in a device defined as a master a client SDO and a server SDO. Attention must be paid to the fact that only one master for each SDO channel may exist in a system.

Note: Only one master can initiate by the system bus an exchange of data via its client SDO.

The identifier assignment for the SDO channels (Rx/Tx) is done according to the Pre-defined Connection Set.

This assignment can be amended by parameterization, in order to solve identifier conflicts in a larger system in which further devices are on the CAN bus alongside the frequency inverters.

Attention! If a system in which an frequency inverter works as a master is produced, the identifier allocations for the SDO channel may not be altered. In this way, an addressing of individual nodes via the field bus/system bus path of the master frequency inverter is possible.

Parameters are read/written via the SDO channels. With the limitation to the SDO Segment Protocol Expedited, which minimizes the requirements of the parameter exchange, the transmittable data are limited to the uint / int / long types. This permits complete parameterization of the frequency inverters via the system bus, as all the settings and practically all the actual values are displayed via these data types.

4.7.2 PDO channels (process data)

Each frequency inverter possesses three PDO channels (Rx/Tx) for the exchange of process data.

The identifier assignment for the PDO channel (Rx/Tx) is done by default according to the Predefined Connection Set. This assignment corresponds to an alignment to a central master control.

In order to produce the logical channels between the devices (transverse movement) on the system bus, the amendment of the PDO identifiers for Rx/Tx is necessary.

Each PDO channel can be operated with time or SYNC control. In this way, the operation behavior can be set for each PDO channel:

The setting of the operation mode is done via the following parameters:

TxPDO1 Function **930**, *TxPDO2* Function **932** und *TxPDO3* Function **934**

RxPDO1 Function **936**, *RxPDO2* Function **937** und *RxPDO3* Function **938**

Operation mode	Function
0 -deactivated	no exchange of data via the PDO channel (Rx and/or Tx)
1 -time-controlled	Tx-PDO's cyclically transmit according to the time specification Rx-PDO's are read in with $T_a = 1$ ms and forward the data received to the application
2 -SYNC controlled	Tx-PDO's transmit the data from the application that are then current after the arrival of the SYNC telegram. Rx-PDO's forward the last data received to the application after the arrival of the SYNC telegram.

For synchronous PDO's, the master (PC, PLC or frequency inverter) generates the SYNC telegram. The identifier assignment for the SYNC telegram is done by default according to the Predefined Connection Set. This assignment can be altered by parameterization.

4.8 Master functionality

An external control or an frequency inverter defined as a master (node ID = 0) can be used as a master. The fundamental tasks of the master are controlling the start of the network (boot-up sequence), generating the SYNC telegram and evaluating the emergency messages of the slaves.

Further, there can be access to the parameterization of all the frequency inverters on the system bus by means of a field bus connection via the client SDO of the master frequency inverter.

4.8.1 Control boot-up sequence, network management

The Minimum Capability Boot-Up method defined according to CANopen is used for the state control of the nodes (nodes).

This method knows the pre-operational, operational and stopped states.

After the initialization phase, all the nodes are in the pre-operational state. The system bus master transmits the NMT command **Start-Remote-Node**. With this command, individual nodes or all the nodes can be started together. An frequency inverter defined as a master starts **all** the nodes with **one** command. After receipt of the Start Remote Node command, the nodes change into the Operational state. From this time on, process data exchange via the PDO channels is activated.

A master in the form of a PLC/PC can start the nodes on the system bus individually and also stop them again.

As the slaves on the system bus need different lengths of time to conclude their initialization phases (especially if external components exist alongside the frequency inverters), an adjustable delay for the change to Operational is necessary. The setting is done in an frequency inverter defined as a system bus master via *Boot-Up Delay 904*.

Parameter		Setting		
No.	Description	Min.	Max.	Factory setting
904	Boot-Up Delay	3500 ms	50000 ms	3500 ms

Properties of the states:

State	Properties
Pre-Operational	Parameterization via SDO channel possible Exchange of process data via PDO channel not possible
Operational	Parameterization via SDO channel possible Exchange of process data via PDO channel possible
Stopped	Parameterization via SDO channel not possible Exchange of process data via PDO channel not possible

Note: Start-Remote-Node is cyclically transmitted with the set delay time by an frequency inverter defined as a system bus master, in order to put slaves added with a delay or temporarily separated from the network back into the Operational state.

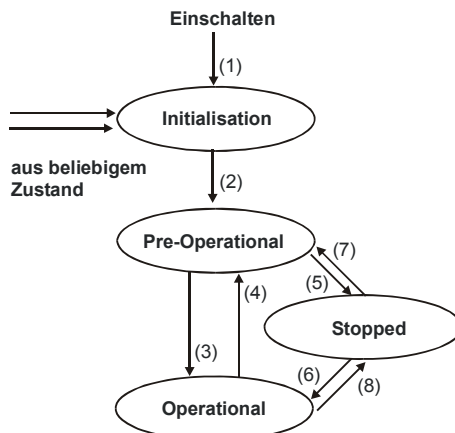

After Power On and the initialization, the slaves are in the Pre-Operational state. The transition (2) is automatic. The system bus master (frequency inverter or PLC/PC) triggers the transition (3) to Operational state. The transitions are controlled via NMT telegrams.

The identifier used for the NMT telegrams is "0" and may only be used by the system bus master for NMT telegrams. The telegram contains two data bytes.

Byte 0	Byte 1
CS (Command Specifier)	Node-ID

Identifier = 0

With the statement of the node ID $\neq 0$, the NMT command acts on the node selected via the node ID. If node ID = 0, **all** the nodes are addressed. If Node-ID = 0, **all** nodes are addressed.

Transition	Command	Command Specifier
(3) , (6)	Start Remote Node	1
(4) , (7)	Enter Pre-Operational	128
(5) , (8)	Stop Remote Node	2
-	Reset Node	129
-	Reset Communication	130

Note: A frequency inverter defined as a system bus master only transmits the command "Start Remote Node" with node ID = 0 (for all nodes). Transmission of the command is done after completion of the initialization phase and the time delay *Boot-Up Delay* **904** following it.

4.8.2 SYNC telegram, generation

If synchronous PDO's have been created on the system bus, the master must send the SYNC telegram cyclically. If an frequency inverter has been defined as a system bus master, the latter must generate the SYNC telegram. The interval for the SYNC telegram of an frequency inverter defined as the system bus master is adjustable. The SYNC telegram is a telegram without data.

The default identifier = 128 according to the Predefined Connection Set.

If a PC or PLC is used as a master, the identifier of the SYNC telegrams can be adapted by parameterization on the frequency inverter.

The identifier of the SYNC telegram must be set identically in all nodes on the system bus.

The setting of the identifier of the SYNC telegram is done via the parameter *SYNC-Identifier* **918**.

Parameter		Setting		
No.	Description	Min.	Max.	Fact. sett.
918	SYNC-Identifier	0	2047	0

The setting "0" results in identifier assignment according to the Predefined Connection Set.

Attention! The identifier range 129...191 may not be used as the emergency telegrams can be found there.

The temporal cycle for the SYNC is set on an frequency inverter defined as a system bus master via the parameter *SYNC-Time* **919**.

Note: A setting of 0 ms for the parameter *SYNC-Time* 919 means "no SYNC telegram".

4.8.3 Emergency message, reaction

If a slave on the system bus suffers a fault, it transmits the emergency telegram. The emergency telegram marks the node ID for the identification of the failed node via its identifier and the existing fault message via its data contents (8 bytes).

After a fault has been acknowledged on the slave, the latter again transmits an emergency telegram with the data content zero.

The emergency telegram has the identifier $128 + \text{node ID}$ (= 129 ... 191)

The system bus master evaluates the emergency telegrams of the slaves. Its reaction to an emergency telegram can be set with *Emergency Reaction* **989**.

Operation mode	Function
0 -Error	The system bus master receives the emergency telegram and switches-off
1 -No Error	Das Emergency Telegram is displayed as a warning

Operation mode - parameter 989 = 0 – Error

Behavior of the system bus master in *Emergency Reaction* **989** = 0 / Error:

As soon as the system bus master receives an emergency telegram, it also switches to failure mode and reports the failed node on the basis of its ID via the kind of error. Only the node is reported, not the cause of the error.

The fault message on the system bus master via *Current error* **260** is **21nn** with **nn** = **node ID** (hexadecimal) of the slave in which a fault switch-off exists. In addition, the system bus master reports the warning Sysbus (0x2000) via the parameter *Warnings* **270** Bit 13.

If a fault switch-off occurs on a number of slaves, the first slave to transmit its emergency telegram is displayed on the system bus master.

Operation mode - parameter 989 = 1 – No Error

Behavior of system bus master in the case of *Emergency Reaction* **989** = 1 / No Error:

As soon as the system bus master receives an emergency telegram, it reports the warning Sysbus (0x2000) via the parameter *Warnings* **270** Bit 13.

Note: In both cases, the Boolean variable SysbusEmergency with source number 730 is set to TRUE in the system bus master. It can be used in the system bus master and (in transmission via a TxPDO) in the slaves for a defined shutdown. SysbusEmergency is also set if the system bus master breaks down. Resetting of SysbusEmergency is done with the fault acknowledgment.

4.8.4 Client SDO (system bus master)

Each node on the system bus can be addressed via the SDO channels. In this way, each node can be addressed and parameterized by one master via its client SDO1. All the parameters of the data types uint/int/long are accessible. String parameters can **not** be processed. If an frequency inverter has been defined as a system bus master, each node on the system bus in this frequency inverter can be addressed by means of a field bus connection (RS232, RS485, Profibus-DP) via its client SDO1.

Note: The second SDO channel SDO2 of the frequency inverters is planned for the parameterization of the frequency inverters via a visualization tool on the system bus.

The service used is SDO Segment Protocol Expedited according to CANopen. An frequency inverter defined as a system bus master automatically generates the correct telegrams. If the SDO channel is operated via a PLC/PC on the system bus, the telegrams must be generated according to the specification.

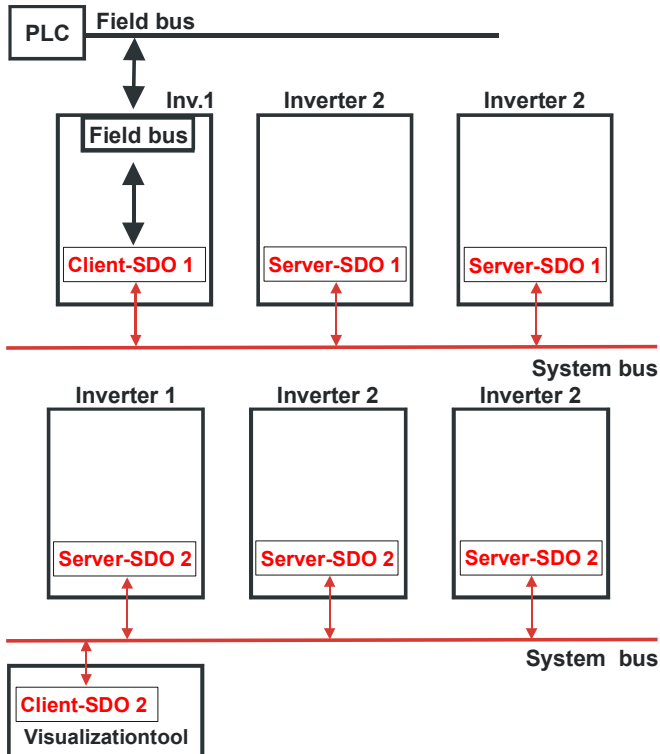

4.9 Slave functionality

4.9.1 Implement boot-up sequence, network management

4.9.1.1 Boot-up message

After the initialization, each slave on the system bus transmits its boot-up message (heartbeat message).

Note: The boot-up telegram has the identifier 1792 + node ID and a data byte with contents = 0x00.

This telegram is of importance if a PLC/PC with CANopen functionality is used as a master. An frequency inverter defined as a system bus master does **not** evaluate the boot-up message.

4.9.1.2 Status control

The identifier used for the NMT telegrams is "0" and may only be used by the system bus master for NMT telegrams. The telegram contains two data bytes.

Byte 0	Byte 1
CS (Command Specifier)	Node-ID

Identifier = 0

With the statement of the node ID $\neq 0$, the NMT command acts on the node selected via the node ID. If node ID = 0, **all** the nodes are addressed. If Node-ID = 0, **all** nodes are addressed.

Transition	Command	Command Specifier
(3),(6)	Start Remote Node	1
(4),(7)	Enter Pre-Operational	128
(5),(8)	Stop Remote Node	2
-	Reset Node	129
-	Reset Communication	130

Attention! The reset node and reset communication command specified according to DS 301 lead to a change to Pre-Operational via Initialization in the frequency inverters. There is a new boot-up message.

After a slave has received the command "Start Remote Node", it activates the PDO channels and is ready for the exchange of process data.

4.9.2 Process SYNC telegram

If synchronous PDO's have been created in an frequency inverter, their processing is synchronized with the SYNC telegram. The SYNC telegram is generated by the system bus master and is a telegram without data.

The identifier is 128 according to the Predefined Connection Set.

If a PC or PLC is used as a master, the identifier of the SYNC telegrams can be adapted by parameterization on the frequency inverter. The identifier of the SYNC telegram must be set identically in all nodes on the system bus.

Attention! The identifier range 129 ... 191 may not be used as the emergency telegrams can be found there.

The setting of the identifier of the SYNC telegram is done via the parameter *SYNC-Identifier* **918**.

Parameter		Setting		
No.	Description	Min.	Max.	Factory setting
918	SYNC-Identifier	0	2047	0

The setting "0" results in identifier assignment according to the Predefined Connection Set.

The data of the Rx-PDO's are forwarded to the application after the arrival of the SYNC telegram. At the same time, the Tx-PDO's with the currently available data from the application are sent.

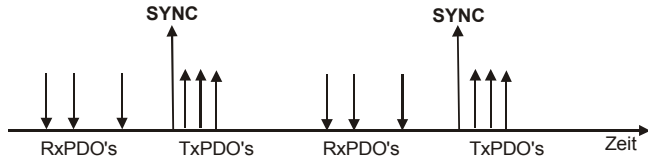

This method enables pre-occupancy of set points in the system bus nodes and a synchronous / parallel take-over of the data.

4.9.3 Emergency message, fault switch-off

As soon as a fault switch-off occurs in a slave frequency inverter, the emergency telegram is transmitted. The emergency telegram marks the node ID for the identification of the failed node via its identifier and the existing fault message via its data contents (8 bytes).

The emergency telegram has the identifier 128 + node ID.

After a fault acknowledgment, another emergency telegram is transmitted, with the data content (Byte 0 ...7) being set to "0" this time. This identifies the node's repeated readiness for operation. If a further fault occurs subsequently, it is transmitted in a new emergency telegram.

The acknowledgment sequence is based on the definitions according to CANopen.

Data contents of the emergency telegram:

Emergency telegram		
Byte	Value	Meaning
0	0x00	low-byte Error-Code
1	0x10	high-byte Error-Code
2	0x80	Error-Register
3	0x00	-
4	0x00	-
5	0x00	-
6	0xnn	internal Error-Code, low-byte
7	0xmm	internal Error-Code, high-byte

Bytes 0, 1 and 2 are firmly defined and compatible with CANopen.
 Bytes 6/7 contain the product specific VECTRON error code.

Error-Code = 0x1000 = general error
 Error-Register = 0x80 = manufacturer-specific error

The explanation and description of the product-specific VECTRON error code can be found in the annex "Error messages".

4.9.4 Server SDO1/SDO2

The communication channel for the exchange of parameter data is the SDO channel. Communication works according to the client/server model. The server is the node holding the data (here the frequency inverter), the client the node requesting or wanting to alter the data (PLC, PC or frequency inverter as system bus master).

For the frequency inverter, two server SDO channels have been implemented. The first SDO channel **SDO1** is used for the parameterization of the PLC/PC as a master or frequency inverter with field bus connection as a system bus master. The second SDO channel **SDO2** is reserved for a visualization tool for parameterization. An exchange of data can only be implemented by the master via a client SDO.

The SDO channels are stipulated for the server SDO's via identifiers according to the Predefined Connection Set to CANopen. As CANopen only provides for and defines one SDO channel in the Predefined Connection Set, the second SDO channel can be deactivated.

In addition, the number of system bus nodes and the adjustable node ID are limited to 63.

Identifier assignment according to the Predefined Connection Set:

Identifier Rx-SDO = 1536 + Node-ID (Node-ID = 1 ... 127, Identifier = 1537 ... 1663)

Identifier Tx-SDO = 1408 + Node-ID (Node-ID = 1 ... 127, Identifier = 1409 ... 1535)

Identifier assignment for SDO1/SDO2 compatible with the Predefined Connection Set:

Identifier Rx-SDO1 = 1536 + Node-ID (Node-ID = 1 ... 63, Identifier = 1537 ... 1599)

Identifier Tx-SDO1 = 1408 + Node-ID (Node-ID = 1 ... 63, Identifier = 1409 ... 1471)

Identifier Rx-SDO2 = 1600 + Node-ID (Node-ID = 0 ... 63, Identifier = 1600 ... 1663)

Identifier Tx-SDO2 = 1472 + Node-ID (Node-ID = 0 ... 63, Identifier = 1472 ... 1535)

This corresponds to the factory settings of the frequency inverters for the SDO's. The node ID = 0 for SDO2 is the system bus master.

Attention! The SDO2 must be deactivated in a CANopen system in order not to generate any compatibility problems.

If an frequency inverter has been defined as the system bus master, the above settings for the SDO1 must be maintained in all the frequency inverters. In this way, access to the parameterization of the frequency inverters via a field bus connection on the master frequency inverter is possible.

The client SDO1 in the master frequency inverter addresses the server SDO1 of the slaves via the above identifiers.

Attention! The identifiers for a visualization tool on the second SDO channel SDO2 cannot be changed.

If a PC or a PLC is used as a master, the identifiers of the **Rx/Tx-SDO1** can be adapted by parameterization on the frequency inverter.

Attention! In free assignment of identifiers, there may not be any double occupancy !

The identifier range 129...191 may not be used as the emergency telegrams can be found there.

The setting of the identifiers of the RxSDO1 is done via the parameter *RxSDO1-Identifier* **921**.

Parameter		Setting		
No.	Description	Min.	Max.	Fact. sett.
921	RxSDO1-Identifier	0	2047	0

The setting of the identifiers of the TxSDO1 is done via parameter number **922**.

Parameter		Setting		
No.	Description	Min.	Max.	Fact. sett.
922	TxSDO1-Identifier	0	2047	0

The setting "0" results in identifier assignment according to the Predefined Connection Set.

The second SDO channel can be deactivated via the *SDO2 Set Active* **923**.

Operation mode	Function
0 -SDO2 deactivated	Communication channel deactivated
1 -SDO2 activated	Communication channel activated for the visualization tool

The identifier assignment for the second SDO channel is always to the specification:

Identifier Rx-SDO2 = 1600 + Node-ID
 Identifier Tx-SDO2 = 1472 + Node-ID

Note: In this way, firm identifiers via which communication takes place are available for the visualization tool.

4.10 Communication channels, SDO1/SDO2

4.10.1 SDO telegrams (SDO1/SDO2)

The service used for the exchange of parameter data is **SDO Segment Protocol Expedited**. The data (type uint, int, long) are exchanged in a telegram.

Access to the parameters in the frequency inverters with a statement of parameter number and data set is displayed via the addressing defined for object access pursuant to the specifications of CANopen via Index/Sub-Index.

Index = parameter number / Sub index = data set.

The data to be transmitted have a length of 2 bytes for uint/int and 4 bytes for long. As standardization and simplification, 4 bytes are always transmitted.

The data are on bytes 4...7 of the SDO telegram.

- uint/int variables are transmitted in bytes 4 and 5 with bytes 6 und 7 = 0.
- long variables are transmitted in bytes 4...7.

Writing parameters:

Client → Server SDO Download (expedited)

0	1	2	3	4	5	6	7
Ctrl. byte	Parameter number		Data set	Data			
0x22	LSB	MSB	0xnn	LSB			MSB
uint/int				LSB	MSB	0x00	0x00
long				LSB	MSB

Server → Client Download Response → Writing process free of errors

0	1	2	3	4	5	6	7
Ctrl. byte	Parameter number		Data set	Data			
0x60	LSB	MSB	0xnn	0			

Server → Client Abort SDO Transfer → Writing process faulty

0	1	2	3	4	5	6	7
Ctrl. byte	Parameter number		Data set	Data			
0x80	LSB	MSB	0xnn	Code	0	0	0

The error code is stated in byte 4 in a faulty reading process.
(see Table, failure codes).

Attention! Control byte 0x22 for the identification "SDO Download expedited" does not consider the bits "s" (data size indicated) and "n" (number of bytes not containing data). If set, they are ignored. The user is responsible for the number of bytes matching the type of data.

Reading parameters:

Client → Server SDO Upload (expedited)

0	1	2	3	4	5	6	7
Ctrl. byte	Parameter number		Data set	Data			
0x40	LSB	MSB	0xnn	0			

Server → Client Upload Response → Reading process free of errors

0	1	2	3	4	5	6	7
Ctrl. byte	Parameter number		Data set	Data			
0x42	LSB	MSB	0xnn	LSB			MSB
uint/int				LSB	MSB	0x00	0x00
long				LSB	MSB

Server → Client Abort SDO Transfer → Reading process faulty

0	1	2	3	4	5	6	7
Ctrl. byte	Parameter number		Data set	Data			
0x80	LSB	MSB	0xnn	Code	0	0	0

The error code is stated in byte 4 in a faulty reading process.
(see Table, failure codes).

failure codes	
Code	Description
1	inadmissible parameter figure
2	inadmissible data set
3	parameter not readable
4	parameter not writable
5	reading error EEPROM
6	writing error EEPROM
7	checksum error EEPROM
8	parameter cannot be written during running drive
9	values of the data sets differ
10	parameter of wrong type
11	unknown parameter
12	BCC error in VECTRON bus protocol
15	unknown error
20	system bus node not available only in access via field bus connection
21	string parameter not admissible only in access via VECTRON bus protocol

Errors marked in the table are generated by the field bus side, not in the Abort SDO Transfer of the system bus.

4.10.2 Communication via field bus connection (SDO1)

If an frequency inverter has been defined as the system bus master and equipped with a field bus interface, access to the parameterization of all the nodes in existence on the system bus is possible by means of this field bus interface via the first SDO channel (SDO1). An expansion has been created in the protocol frame of the field buses for this purpose.

Attention! The prerequisite for this mechanism is that the identifier setting for the first SDO channel (SDO1) corresponds to the Predefined Connection Set. The parameter addressed must also be existent in the system bus master.

4.10.2.1 Profibus-DP

If an object with communication channel (PKW) is used in Profibus-DP, access to all the other nodes on the system bus can be done via it. The structure of the communication channel permits an additional addressing of a system bus node. This is done by the use of an unused byte in the communication channel.

Communication channel PKW

0	1	2	3	4	5	6	7
PKE		Index	-	Data			
AK/SPM	Parameter number	Data set	Node-ID system bus				

Byte 3 is used to transmit the node ID of the required node on the system bus. If byte 3 = 0, the master inverter of the system bus is addressed. The display is binary (0...63).

4.10.2.2 RS232/RS485 with VECTRON bus protocol

In the VECTRON bus protocol, there is a byte in the telegram header that is always transmitted with 0 as a standard feature.

ENQUIRY

0	1	2	3	4	5	6
Address	0	p	n	n	n	ENQ
	Node-ID system bus	Data set	Parameter number			

SELECT

0	1	2	3	4			
Address	STX	0	p	n	n	n	...
		Node-ID System bus	Data set	Parameter number			

Byte 1 in the enquiry and byte 2 in the select telegram are not defined and are used to transmit the node ID of the required node on the system bus. If this byte = 0, the master inverter of the system bus is addressed. The display is ASCII corresponding to the conventions for the display of the address in the VECTRON bus protocol.

Note: If there is an NAK fault message, the error is to be read out from the system bus master with node ID = 0 via parameter 11.

Display of node ID system bus in the VECTRON bus protocol:

System bus Node-ID					
System bus address	(ASCII-) character	HEX value	System bus address	(ASCII-) character	HEX value
1	A	41	31		5F
2	B	42	32		60
3	C	43	33	a	61
4	D	44	34	b	62
5	E	45	35	c	63
6	F	46	36	d	64
7	G	47	37	e	65
8	H	48	38	f	66
9	I	49	39	g	67
10	J	4A	40	h	68
11	K	4B	41	i	69
12	L	4C	42	j	6A
13	M	4D	43	k	6B
14	N	4E	44	l	6C
15	O	4F	45	m	6D
16	P	50	46	n	6E
17	Q	51	47	o	6F
18	R	52	48	p	70
19	S	53	49	q	71
20	T	54	50	r	72
21	U	55	51	s	73
22	V	56	52	t	74
23	W	57	53	u	75
24	X	58	54	v	76
25	Y	59	55	w	77
26	Z	5A	56	x	78
27	[5B	57	y	79
28	\	5C	58	z	7A
29]	5D	59	{	7B
30	^	5E	60		7C
			61	}	7D
			62	~	7E
			63	□	7F

4.11 Process data channels, PDO

4.11.1 Identifier assignment process data channel

The process channel for the exchange of process data under CANopen is the PDO channel. Up to three PDO channels with differing properties can be used in one device.

The PDO channels are defined via identifiers according to the Predefined Connection Set to CANopen:

Identifier 1. Rx-PDO = 512 + Node-ID
Identifier 1. Tx-PDO = 384 + Node-ID

Identifier 2. Rx-PDO = 768 + Node-ID
Identifier 2. Tx-PDO = 640 + Node-ID

Identifier 3. Rx-PDO = 1024 + Node-ID
Identifier 3. Tx-PDO = 896 + Node-ID

This corresponds to the factory settings of the frequency inverters for the Rx/Tx-PDO's. This occupancy is aligned to an external master (PLC/PC) serving all the channels.

If the PDO channels are used for a connection of the frequency inverters amongst one another, the identifiers are to be set accordingly by parameterization.

Attention! In free assignment of identifiers, there may not be any double occupancy !

The identifier range 129...191 may not be used as the emergency telegrams can be found there.

Setting of the identifiers of the Rx/TxPDO's:

Parameter		Setting		
No.	Description	Min.	Max.	Fact. sett.
924	RxPDO1 Identifier	0	2047	0
925	TxPDO1 Identifier	0	2047	0
926	RxPDO2 Identifier	0	2047	0
927	TxPDO2 Identifier	0	2047	0
928	RxPDO3 Identifier	0	2047	0
929	TxPDO3 Identifier	0	2047	0

The setting "0" results in identifier assignment according to the Predefined Connection Set.

4.1.1.2 Operation modes process data channel

The transmit/receive behavior can be time controlled or controlled via a SYNC telegram. The behavior can be parameterized for each PDO channel.

Tx-PDO's can work time controlled or SYNC controlled. A time controlled TxPDO transmits its data at the interval of time set. A SYNC controlled TxPDO transmits its data after the arrival of a SYNC telegram.

RxPDO's in the time controlled setting forward the received data to the application immediately. If an RxPDO has been defined as SYNC controlled, its forwards its received data to the application after the arrival of a SYNC telegram.

Settings TxPDO1/2/3

Parameter		Setting		
No.	Description	Min.	Max.	Fact. sett.
931	TxPDO1 Time	1 ms	50000 ms	8 ms
933	TxPDO2 Time	1 ms	50000 ms	8 ms
935	TxPDO3 Time	1 ms	50000 ms	8 ms

The setting of the operation mode is done via the following parameters:
TxPDO1 Function 930, TxPDO2 Function 932 und TxPDO3 Function 934

Operation mode	Function
0 -Not Active	No data are sent.
1 -Controlled by time	In the cycle of the adjusted time interval the data are sent.
2 -Controlled by SYNC	To arrival of a SYNC telegram the data are sent.

Settings RxPDO1/2/3

The setting of the operation mode is done via the following parameters:
RxPDO1 Function 936, RxPDO2 Function 937 und RxPDO3 Function 938

Operation mode	Function
0 -Controlled by time	The received data are passed on immediately.
1 -Controlled by SYNC	After arrival of a SYNC telegram the received data are passed on.

Note: In the "controlled by time" operation mode, there is a polling of the received data with the trigger cycle of $T_a = 1$ ms.

4.11.3 Timeout monitoring process data channel

Each frequency inverter monitors its received data for whether they are updated within a defined time window.
The monitoring is done onto the SYNC telegram and the RxPDO channels.

Monitoring SYNC / RxPDO's

No.	Parameter Description	Setting		
		Min.	Max.	Fact. sett.
939	SYNC Timeout	0 ms	60000 ms	0 ms
941	RxPDO1 Timeout	0 ms	60000 ms	0 ms
942	RxPDO2 Timeout	0 ms	60000 ms	0 ms
945	RxPDO3 Timeout	0 ms	60000 ms	0 ms

Setting "0" means no timeout monitoring.

Attention! There is only monitoring for the SYNC telegram if at least one RxPDO or one TxPDO channel is defined as SYNC controlled.

If a timeout period is exceeded, the frequency inverter switches to failure mode and reports one of the faults:

F2200 System bus Timeout SYNC

F2201 System bus Timeout RxPDO1

F2202 System bus Timeout RxPDO2

F2203 System bus Timeout RxPDO3

4.11.4 Communication relationships of the process data channel

Regardless of the process data to be transmitted, the communication relationships of the process data channels must be defined. The connection of PDO channels is done via the assignment of the identifiers. The identifiers of Rx-/Tx-PDO must match in each case.

There are two principal possibilities:

- **one** Rx-PDO to **one** Tx-PDO (one to one)
- connect **several** Rx-PDO's to **one** TxPDO (one to many)

This process is documented in a tabular form via a **communication relationship list**.

Example:

Frequency inverter 1		Frequency inverter 2		Frequency inverter 3	
PDO	Identifier	PDO	Identifier	PDO	Identifier
TxPDO1	385	TxPDO1		TxPDO1	
RxPDO1		RxPDO1	385	RxPDO1	385
TxPDO2	641	TxPDO2		TxPDO2	642
RxPDO2		RxPDO2	641	RxPDO2	
TxPDO3		TxPDO3		TxPDO3	
RxPDO3		RxPDO3	642	RxPDO3	

Attention! All the TxPDO's used must have different identifiers!
The Identifier must be clear in the system bus network.

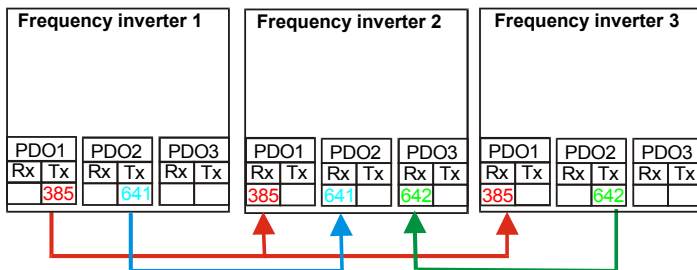

4.11.5 Virtual links

A PDO telegram contains 0 ... 8 data bytes according to CANopen. A mapping for any kind of objects can be done in these data bytes.

For the system bus, the PDO telegrams are firmly defined with 8 data bytes. The mapping is not done via mapping parameters as with CANopen, but via the method of sources and links.

Each function provides its output data via a source. These sources are defined via source numbers. The input data of functions are defined via parameters. The link of a data input to a data output is done via the assignment of parameters to source numbers.

Example 1:

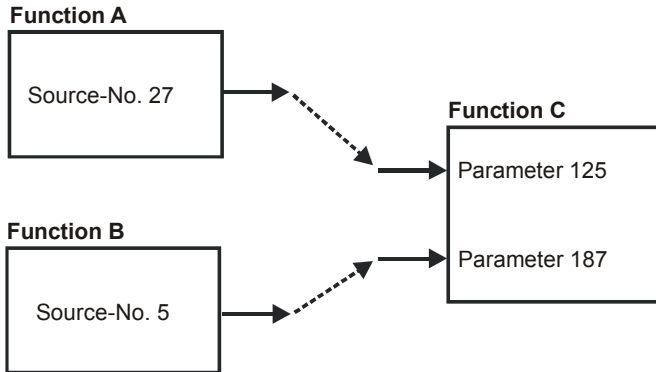

In example 1, the two inputs of function C are connected to the outputs of functions A and B. The parameterization for this connection is thus:

Function C

Parameter 125 = Source-No. 27
Parameter 187 = Source-No. 5

Example of a virtual link in VPlus:

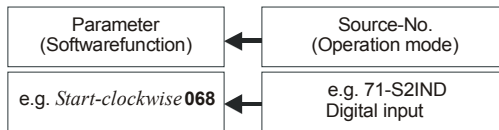

The assignment of the operation modes to the software functions available can be adapted to the application in question.

For the system bus, the input data of the TxPDO's are also displayed as input parameters and the output data of the RxPDO's as sources.

Example 2:

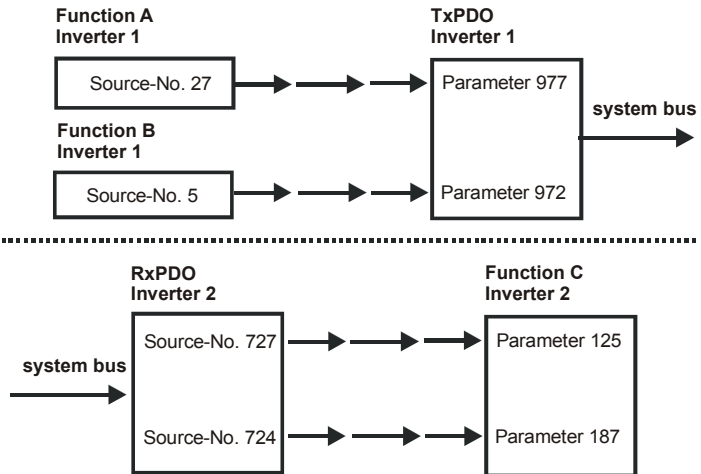

Example 2 displays the same situation as Example 1. But now, the functions A and B are in frequency inverter 1 and function C in frequency inverter 2. The connection is done via a TxPDO in frequency inverter 1 and a RxPDO in frequency inverter 2. Thus, the parameterization for this connection is:

Frequency inverter 1

Parameter 977 = Source-No. 27
Parameter 972 = Source-No. 5

Frequency inverter 2

Parameter 125 = Source-No. 727
Parameter 187 = Source-No. 724

As the links with the system used exceed the device limits, they are termed "virtual links".

The virtual links with the possible sources are related to the Rx/TxPDO channels. For this purpose, the eight bytes of the Rx-/TxPDO's are defined structured as inputs and sources. This exists for each of the three PDO channels.

Each transmit PDO and receive PDO can be occupied as follows:

4 Boolean variables

or

4 uint/int variables

or

2 long variables

or

a mixture paying attention to the eight bytes available

Assignment data type / number of bytes:

Assignment	
Data type	Length
Boolean	2 Bytes
uint/int	2 Bytes
long	4 Bytes

4.11.5.1 Input parameters of the TxPDO's for data to be transmitted

The listed parameters can be used to stipulate the data that are to be transported there for each position in the TxPDO telegrams. The setting is done in such a way that a source number is entered for the required data in the parameters.

TxPDO1	P. No. Boolean input	TxPDO1	P. No. uint/int input	TxPDO1	P. No. long input
Byte		Byte		Byte	
0	946	0	950	0	954 Long1
1	Boolean1	1	Word1	1	
2	947	2	951	2	
3	Boolean2	3	Word2	3	955 Long2
4	948	4	952	4	
5	Boolean3	5	Word3	5	
6	949	6	953	6	
7	Boolean4	7	Word4	7	

TxPDO2	P. No. Boolean input	TxPDO2	P. No. uint/int input	TxPDO2	P. No. long input
Byte		Byte		Byte	
0	956	0	960	0	964 Long1
1	Boolean1	1	Word1	1	
2	957	2	961	2	
3	Boolean2	3	Word2	3	965 Long2
4	958	4	962	4	
5	Boolean3	5	Word3	5	
6	959	6	963	6	
7	Boolean4	7	Word4	7	

TxPDO3	P. No. Boolean input	TxPDO3	P. No. uint/int input	TxPDO3	P. No. long input
Byte		Byte		Byte	
0	966	0	972	0	976 Long1
1	Boolean1	1	Word1	1	
2	967	2	973	2	
3	Boolean2	3	Word2	3	977 Long2
4	968	4	974	4	
5	Boolean3	5	Word3	5	
6	969	6	975	6	
7	Boolean4	7	Word4	7	

Note: Depending on the selected data information the percentages values are displayed via the uint/int inputs.

With this method, there are up to three possibilities for a meaning of the contents of the individual bytes. Each byte may only be used for one possibility.

To ensure this, the processing of the input links is derived from the setting. If an input link has been set to the fixed value of zero, it is **not** processed.

The settings for the fixed value zero are:

Source = 7 (FALSE) for Boolean variables
 Source = 9 (0) for uint, int, long variables

This is simultaneously the factory setting.

Examples Boolean source

Boolean source	
Source	Data
6	TRUE
7	FALSE
70	Contact input 1
71	Contact input 2
72	Contact input 3
161	Running message
163	Nominal figure reached
164	Set frequency reached (P. 510)

Examples uint/int source

unit/int source	
Source	Data
9	0
63	Reference percentage 1
64	Reference percentage 2
52	Percentage MFI1
133	Output percentage ramp
137	Output reference percentage channel
138	Output actual percentage channel
740	Control word
741	State word

Examples long source

long source	
Source	Data
9	0
0	Output frequency ramp
1	Fixed frequency 1
5	Reference line value
62	Output frequency reference value channel
50	Reference frequency MFI1

4.11.5.2 Source numbers of the RxPDO's for received data

Equivalent to the input links of the TxPDO's, the received data of the RxPDO's are displayed via sources or source numbers. The sources existing in this way can be used in the frequency inverter via the local input links for the data targets.

RxPDO1	Source No.	RxPDO1	Source No.	RxPDO1	Source No.
Byte	Boolean value	Byte	uint/int value	Byte	long-Value
0	700	0	704	0	708 Long1
1	Boolean1	1	Word1	1	
2	701	2	705	2	
3	Boolean2	3	Word2	3	709 Long2
4	702	4	706	4	
5	Boolean3	5	Word3	5	
6	703	6	707	6	
7	Boolean4	7	Word4	7	

RxPDO2	Source No.	RxPDO2	Source No.	RxPDO2	Source No.
Byte	Boolean value	Byte	uint/int value	Byte	long value
0	710	0	714	0	718 Long1
1	Boolean1	1	Word1	1	
2	711	2	715	2	
3	Boolean2	3	Word2	3	719 Long2
4	712	4	716	4	
5	Boolean3	5	Word3	5	
6	713	6	717	6	
7	Boolean4	7	Word4	7	

RxPDO3	Source No.	RxPDO3	Source No.	RxPDO3	Source No.
Byte	Boolean value	Byte	uint/int value	Byte	long value
0	720	0	724	0	728 Long1
1	Boolean1	1	Word1	1	
2	721	2	725	2	
3	Boolean2	3	Word2	3	729 Long2
4	722	4	726	4	
5	Boolean3	5	Word3	5	
6	723	6	727	6	
7	Boolean4	7	Word4	7	

With this method, there are up to three possibilities for a meaning of the contents of the individual bytes. Each byte may only be used for one possibility.

Note: Depending on the selected data information the percentages values are displayed via the **uint/int** inputs.

4.11.5.3 Examples of virtual links

Example 1:

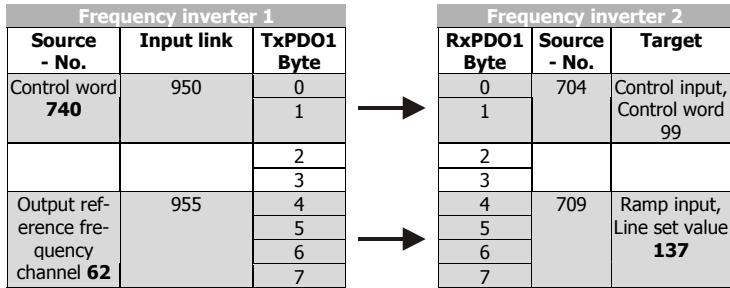

Parameter 950 = Source-No. 740
Parameter 955 = Source-No. 62

Parameter 99 = Source-No. 704
Parameter 137 = Source-No. 709

The control word of frequency inverter 1 is linked with the control word of frequency inverter 2. In this way, both frequency inverters can be operated synchronously via the remote control. The output of the reference value channel of frequency inverter 1 is laid onto the output of the ramp of frequency inverter 2. In this way, both frequency inverters have a joint source of reference values and are given reference values in the internal notation.

As an extension, a number of frequency inverters can also exist on the receive side (Rx), these then being supplied with data parallel and simultaneously.

The input link not used in the TxPDO1 of frequency inverter 1 is on ZERO and is thus not served.

Example 2:

Example of a virtual link with transmission via the system bus:

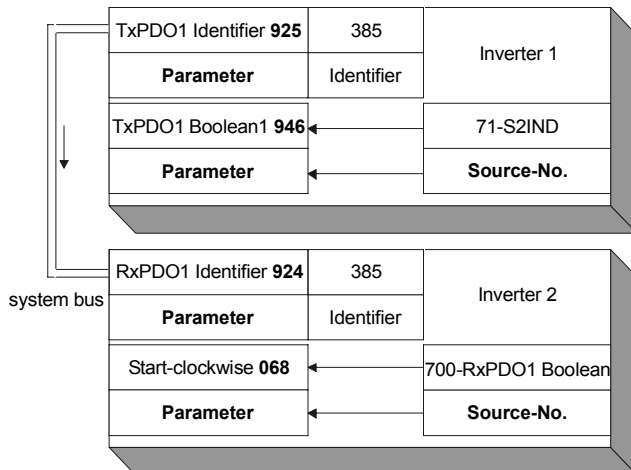

4.12 Control parameters

For the monitoring of the system bus and the display of the internal states, two control parameters are provided. There is a report of the system bus state and a report of the CAN state via two actual value parameters.

The parameter *Node-State* **978** gives information about the Pre-Operational, Operational, Stopped state. A PDO transfer is only possible in the Operational state. The state is controlled by the system bus master (PLC / PC / frequency inverter) via NMT telegrams.

The parameter *CAN-State* **979** gives information about the state of the physical layer. If there are transmission errors, the state changes from OKAY to WARNING until the cancellation of the communication with BUS-OFF. After BUS-OFF, the CAN controller is automatically re-initialized and the system bus started again.

Note: If the BUS-OFF state occurs, the frequency inverter breaks down with "**F2210 BUS-OFF**".

After Bus-OFF, the system bus in the frequency inverter is completely reinitialized. There is a new boot-up message from the node and an emergency telegram with the Bus-OFF message is transmitted. The change of state of the node to Operational is done by the Start-Remote-Node telegram cyclically sent by the system bus master.

Actual values of the system bus		
No.	Description	Display
978	Node-State	1 - Pre-Operational 2 - Operational 3 - Stopped
979	CAN-State	1 - OKAY 2 - WARNING 3 - BUS-OFF

4.13 Handling of the parameters of the system bus

As soon as the system bus expansion module EM-SYS exists in an frequency inverter, the actual value parameters for system state and bus state are activated and can be observed in the actual value menu **VAL** of the control unit KP500 or with the VPlus PC program in the menu **Actual values \ Systembus**.

Note: The actual value parameters are on control level 3 and are thus available for the user at any time.

All the setting parameters for the configuration of the system bus are not directly accessible for the user. For defined customer applications, pre-defined XPI files can be generated by VECTRON for the VPlus PC program, with which the necessary parameters are visible for the user. The application-relevant variables are then available in these XPI files.

Note: XPI files can be read in addition to the loaded parameter information of the frequency inverter into the VPlus PC program.
In the menu of the software under the point "Edit" you find the command "Read in XPI file".

The method of working via an XPI file has its reasoning in the fact that deep interventions in the system are possible via the system bus and can lead to serious problems in the application with an untrained user. Via the XPI files, a user is given a selection list pre-defined by VECTRON.

Attention! The configuration of the necessary parameters for the system bus is accessible by a XPI file with the help of the VPlus PC program.
The control unit KP500 does not support this functionality.
If the expansion module system bus EM-SYS is installed additionally to a communication module for the field bus connection (CM-232, CM-485 or CM-PDP) in the frequency inverter, the parameterization can be made with the interface adapter KP232.

Experienced users have complete access to all the existing sources and possible input links with the XPI file of the active functions. The selection depends on the selected configuration and control procedure.

The display of the parameters when using the XPI file is according to the following structure:

System bus	
Basic Settings	900Node-ID 903Baud-Rate
Master Functions	904Boot-Up Delay 919SYNC-Time
SYNC-Identifier	918SYNC-Identifier
SDO1-Identifier	921RxSDO1-Identifier 922TxSDO1-Identifier
SDO2 Set Active	923SDO2 Set Active
PDO-Identifier	924RxPDO1-Identifier 925TxPDO1-Identifier 926RxPDO2-Identifier 927TxPDO2-Identifier 928RxPDO3-Identifier 929TxPDO3-Identifier

TxPDO-Function	930TxPDO1 Function 931TxPDO1 Time 932TxPDO2 Function 933TxPDO2 Tome 934TxPDO3 Function 935TxPDO3 Time
RxPDO-Function	936RxPDO1 Function 937RxPDO2 Function 938RxPDO3 Function
Timeout	939SYNC Timeout 941RxPDO1 Timeout 942RxPDO2 Timeout 945RxPDO3 Timeout
TxPDO1 Objects	946TxPDO1 Boolean1 947TxPDO1 Boolean2 948TxPDO1 Boolean3 949TxPDO1 Boolean4 950TxPDO1 Word1 951TxPDO1 Word2 952TxPDO1 Word3 953TxPDO1 Word4 954TxPDO1 Long1 955TxPDO1 Long2
TxPDO2 Objects	956TxPDO2 Boolean1 957TxPDO2 Boolean2 958TxPDO2 Boolean3 959TxPDO2 Boolean4 960TxPDO2 Word1 961TxPDO2 Word2 962TxPDO2 Word3 963TxPDO2 Word4 964TxPDO2 Long1 965TxPDO2 Long2
TxPDO3 Objects	966TxPDO3 Boolean1 967TxPDO3 Boolean2 968TxPDO3 Boolean3 969TxPDO3 Boolean4 972TxPDO3 Word1 973TxPDO3 Word2 974TxPDO3 Word3 975TxPDO3 Word4 976TxPDO3 Long1 977TxPDO3 Long2
Actual values	
System bus	978Node-State 979CAN-State

4.14 Utilities

For the planning of the system bus according to the drive tasks in question, there are utilities in the form of tables.

The planning of the system bus is done in three steps:

1. Definition of the communication relationships
2. Production of the virtual links
3. Capacity planning of the system bus

The priority assignment of the identifiers is relevant for the definition of the communication relationships. Data that are to be transmitted with a higher priority must be given low identifiers. This results in the message with the higher priority being transmitted first with a simultaneous access of two nodes to the bus.

Note: The recommended identifier range for the communication relationships via the PDO channels is 385 ... 1407.

The identifiers below 385 are used for the NMT telegrams (boot-up sequence, SYNC telegram) and emergency message.

The identifiers above 1407 are used for the SDO channel for parameterization.

4.14.1 Definition of the communication relationships

The communication relationships are planned and documented with the help of the table. The table is available as a Microsoft Word document "kbl.doc" on the BONFIGLIOLI VECTRON product CD or upon request.

Inverter: _____	Inverter: _____	Inverter: _____	Inverter: _____	Inverter: _____
Node-ID: _____	Node-ID: _____	Node-ID: _____	Node-ID: _____	Node-ID: _____
PDO	Identifier	PDO	Identifier	PDO
TxPDO1		TxPDO1		TxPDO1
RxPDO1		RxPDO1		RxPDO1
TxPDO2		TxPDO2		TxPDO2
RxPDO2		RxPDO2		RxPDO2
TxPDO3		TxPDO3		TxPDO3
RxPDO3		RxPDO3		RxPDO3

4.14.2 Production of the virtual links

The virtual links are planned and documented with the help of the table. The table is available as a Microsoft Word document "vvk.doc" on the BONFIGLIOLI VECTRON product CD or upon request.

Inverter: _____ Node-ID: _____ TxPDO-No.: _____	Identifier: _____ (Tx/RxPDO)	Inverter: _____ Node-ID: _____ RxPDO-No.: _____	Source-No. Input Link/Parameter-No. Boolean uint/int long
			

4.14.3 Capacity planning of the system bus

Each PDO telegram possesses a constant useful data content of 8 Bytes. According to worst case, this results in a maximum telegram length of 140 bits. The maximum telegram run time of the PDO's is thus stipulated via the set baud rate.

Capacity planning	
Baud rate / kBaud	Telegram run time / μ s
1000	140
500	280
250	560
125	1120
100	1400
50	2800

As a function of the set baud rate and the transmission interval of the TxPDO's selected, the following bus loads results:

Capacity of the system bus										
Baud rate / kBaud	Bus load as a function of the transmission for one TxPDO in %									
	1ms	2ms	3ms	4ms	5ms	6ms	7ms	8ms	9ms	10ms
1.000	14	7	4.7	3.5	2.8	2.3	2	1.8	1.6	1.4
500	28	14	9.3	7	5.6	4.7	4	3.5	3.1	2.8
250	56	28	18.7	14	11.2	9.3	8	7	6.2	5.6
125	112	56	37.3	28	22.4	18.7	16	14	12.4	11.2
100	140	70	46.7	35	28	23.3	20	17.5	15.6	14
50	280	140	93.3	70	56	46.7	40	35	31.1	28

Attention! A bus load >100% means that a telegram cannot be dispatched completely between two transmission times.

Such a setting is not admissible!

This observation must be done for each TxPDO. The sum of all the TxPDO's decides on the entire bus load. The bus load must be designed in such a way that any telegram repetitions for transmission errors are possible without exceeding the bus capacity.

Note: To facilitate capacity planning, an Microsoft Excel file with the name "Load_Systembus.xls" is available.

The capacity planning are planned and documented with the help of the table. The work sheet is available as a Microsoft Excel document "Load_Systembus.xls" on the VECTRON product CD or by request.

Load system bus			
Baud rate [kBaud]: 50, 100, 125, 250, 500, 1000			1000
Frequency inverter	TxPDO Number	Ta [ms]	Workload [%]
1	1	0	0
	2	0	0
	3	0	0
2	1	0	0
	2	0	0
	3	0	0
3	1	0	0
	2	0	0
	3	0	0
4	1	0	0
	2	0	0
	3	0	0
5	1	0	0
	2	0	0
	3	0	0
6	1	0	0
	2	0	0
	3	0	0
7	1	0	0
	2	0	0
	3	0	0
8	1	1	14
	2	1	14
	3	1	14
9	1	1	14
	2	1	14
	3	0	0
10	1	0	0
	2	0	0
	3	0	0
Total workload [%]			70

In the table, the set baud rate is entered from the parameter *Baud-Rate* **903** in kBaud. For each frequency inverter, the set time for the transmission interval (e. g. *TxPDO1 Time* **931**) in ms is entered for the TxPDO being used at the time. In the column **Load** the bus load caused by the individual TxPDO appears, under **Total Load** the entire bus load.

For the bus load (Total load) the following limits have been defined:

≤ 80 % → OKAY
 80 ... 90 % → CRITICAL
 > 90 % → NOT POSSIBLE

5 Control inputs and outputs

5.1 Analog input EM-S1INA

5.1.1 General

The analog input of the EM-IO-03 expansion module can optionally be configured as a voltage or a current input. Parameterization of the input signal is done by the definition of a linear characteristic and assignment as a

- reference value source
(can be selected via the parameter *Reference frequency source 475*),
- reference percentage source
(can be selected via the parameter *Reference percentage source 476*),
- actual percentage source
(can be selected via the parameter *Actual percentage source 478*, in configuration **x11**) or
- limit value source
(can be selected via the parameter *Limit Source 734...737*).

5.1.2 Configuration voltage/current input

The analog input of the EM-IO-03 expansion module has been configured in the factory setting for a voltage signal of +/-10 V.

Switch **S3** enables a switch-over of the operation mode for an analog current signal of +/-20 mA.

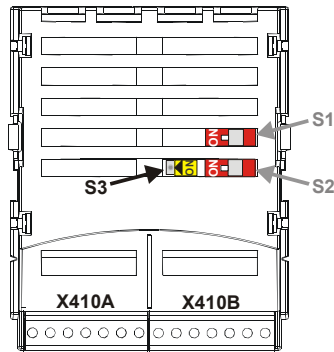

Operation mode – switch S3	Function
OFF -Voltage input	OFF (to the right) – analog input EM-S1INA is configured for a voltage signal.
ON -Current input	ON (to the left) – analog input EM-S1INA is configured for a current signal.

Note: With the two switches **S1** and **S2**, the bus connection of the system bus interface is configured (refer to chapter "System Bus Interface").

5.1.3 Characteristic

The mapping of the analog input signals onto a frequency or percentage reference value is possible for various demands. The parameterization is to be done via two points of the linear characteristic of the reference channel.

The characteristic point 1, with the coordinates X1 and Y1, and the characteristic point 2, with the coordinates X2 and Y2, are to be set in the four data sets.

The characteristic points X1 and X2 are stated as percentages, as the analog input can be switched as a current or voltage input via switch S3.

Parameter		Setting		
No.	Description	Min.	Max.	Fact. sett.
564	Characteristic point X1	-100.00 %	100.00 %	-98.00 %
565	Characteristic point Y1	-100.00 %	100.00 %	-100.00 %
566	Characteristic point X2	-100.00 %	100.00 %	98.00 %
567	Characteristic point Y2	-100.00 %	100.00 %	100.00 %

The coordinates of the characteristic points are related as a percentage to the analog signal, with 10 V or 20 mA, and the parameter *Maximum Frequency* **419** or parameter *Maximum reference percentage* **519**. The change of direction of rotation can be done via the digital inputs and/or by selecting the characteristic points.

The definition of the analog input characteristic can be calculated via the two-point form of the straight line equation. The speed Y of the drive mechanism is controlled according to the analog control signal X.

$$Y = \frac{Y2 - Y1}{X2 - X1} \cdot (X - X1) + Y1$$

Attention! Monitoring of the analog input signal via the parameter *Error/Warning Behavior* **563** demands a check of the characteristic parameters. Sensible use is only possible if the *Characteristic point X1* **564** is in the positive range.

5.1.4 Operation modes

The operation modes of the analog input characteristic enable application-related scaling as a supplement to the characteristic points stated. One of the four linear types of characteristic is selected for adaptation of the signal for the analog input signal via the parameter *Operation mode* **562**. If the characteristic points are not suited for the type of characteristic selected, the characteristic points are corrected internally.

Operation mode	Function
1 -bipolar	The analog input signal is mapped onto the reference figure according to the characteristic points (X1/Y1) and (X2/Y2).
11 -unipolar	With a negative parameter value of the characteristic points X1 or X2, they are mapped to the reference value zero.
21 -unipolar 2...10 V / 4...20 mA	If the characteristic points X1 or X2 have been set with a negative parameter figure or smaller than 20%, the input characteristic is mapped to the reference value 20%.
101 -bipolar abs. value	Negative parameter values of the characteristic points Y1 or Y2 are mapped as a positive reference value in the characteristic.

Further information on the operation modes stated in the table can be found in the following chapter "Examples".

5.1.4.1 Examples

The analog input signal is mapped onto a reference value as a function of the characteristic. The following examples show the operation modes for an analog voltage signal. The parameter *Minimum Frequency* **418** is set to the value 0.00 Hz. The characteristic point 100% for the Y axis corresponds to the parameter *Maximum Frequency* **419** of 50.00 Hz in the examples

Attention! The various operation modes change the input characteristic as a function of the parameterized characteristic points. In the following examples, the areas of the system of coordinates from which a characteristic point is displaced are marked.

Operation mode "1 – bipolar"

In operation mode "1 – bipolar", the characteristic of the analog input can be freely set by stating two characteristic points.

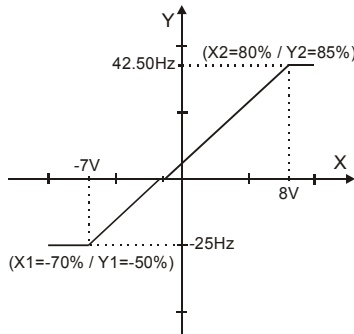

Characteristic point 1:

$$X1 = -70.00\% \cdot 10 \text{ V} = -7.00 \text{ V}$$

$$Y1 = -50.00\% \cdot 50.00 \text{ Hz} = -25.00 \text{ Hz}$$

Characteristic point 2:

$$X2 = 80.00\% \cdot 10 \text{ V} = 8.00 \text{ V}$$

$$Y2 = 85.00\% \cdot 50.00 \text{ Hz} = 42.50 \text{ Hz}$$

Tolerance band:

$$\Delta X = 2.00\% \cdot 10 \text{ V} = 0.20 \text{ V}$$

The change of direction of rotation is done in the example at an analog input signal of -1.44 V, with a tolerance band of ± 0.20 V.

Operation mode "11 – unipolar"

In operation mode "11 – unipolar", the characteristic points are displaced to the origin of the characteristics with a negative value for the X axis.

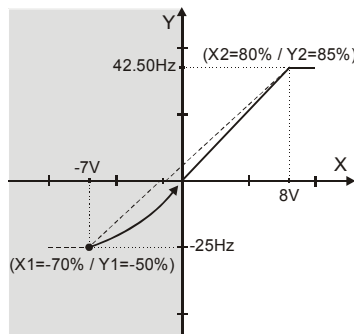

Characteristic point 1:

$$X1 = -70.00\% \cdot 10 \text{ V} = -7.00 \text{ V}$$

$$Y1 = -50.00\% \cdot 50.00 \text{ Hz} = -25.00 \text{ Hz}$$

Characteristic point 2:

$$X2 = 80.00\% \cdot 10 \text{ V} = 8.00 \text{ V}$$

$$Y2 = 85.00\% \cdot 50.00 \text{ Hz} = 42.50 \text{ Hz}$$

Tolerance band:

$$\Delta X = 2.00\% \cdot 10 \text{ V} = 0.20 \text{ V}$$

The characteristic point 1 has been displaced to the origin. The parameter *Tolerance band* **560** is not taken into account in this example, as no change of sign of the reference frequency value takes place.

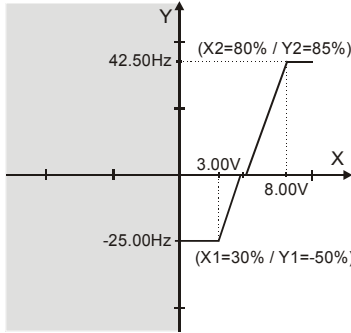

Characteristic point 1:

$$X1 = 30,00\% \cdot 10 \text{ V} = 3.00 \text{ V}$$

$$Y1 = -50,00\% \cdot 50,00 \text{ Hz} = -25.00 \text{ Hz}$$

Characteristic point 2:

$$X2 = 80,00\% \cdot 10 \text{ V} = 8.00 \text{ V}$$

$$Y2 = 85,00\% \cdot 50,00 \text{ Hz} = 42.50 \text{ Hz}$$

Tolerance band:

$$\Delta X = 2,00\% \cdot 10 \text{ V} = 0.20 \text{ V}$$

The change of direction of rotation is done in the example at an analog input signal of 4.85 V, with a tolerance band of $\pm 0.20 \text{ V}$.

Operation mode "21 – unipolar 2...10 V / 4...20 mA"

This operation mode limits the input characteristic to the range between 5% and 100% of the analog input signal. If the value for a characteristic point of the X axis is outside 5%, it is mapped to the characteristic point (2 V / 0 Hz).

The characteristic point on the X axis is calculated according to the following formula:

$$\text{characteristic point X} = \text{parameter value X} \cdot (100,00\% - 20,00\%) + 20,00\%$$

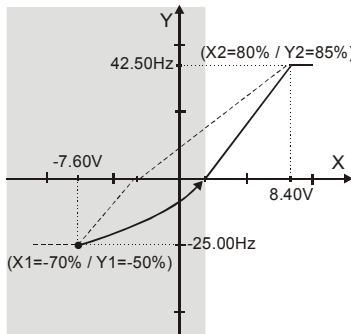

Characteristic point 1:

$$X1 = [-70,00\% \cdot (100,00\% - 20,00\%) + 20,00\%] \cdot 10 \text{ V} = -7.60 \text{ V}$$

$$Y1 = -50,00\% \cdot 50,00 \text{ Hz} = -25.00 \text{ Hz}$$

Characteristic point 2:

$$X2 = [80,00\% \cdot (100,00\% - 20,00\%) + 20,00\%] \cdot 10 \text{ V} = 8.40 \text{ V}$$

$$Y2 = 85,00\% \cdot 50,00 \text{ Hz} = 42.50 \text{ Hz}$$

Tolerance band:

$$\Delta X = [2,00\% \cdot (100,00\% - 20,00\%) \cdot 10 \text{ V}] = 0.16 \text{ V}$$

The characteristic point 1 has been displaced to the point (2.00V / 0.00 Hz). The parameter *Tolerance band 560* is not taken into account in this example, as no change of sign of the reference frequency value takes place.

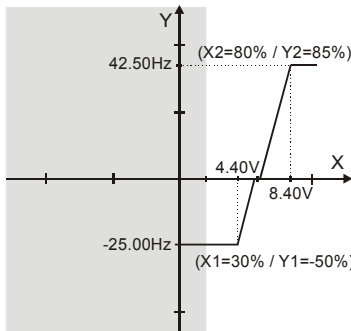

Characteristic point 1:

$$X1 = [30,00\% \cdot (100,00\% - 20,00\%) + 20,00\%] \cdot 10 \text{ V} = 4.40 \text{ V}$$

$$Y1 = -50,00\% \cdot 50,00 \text{ Hz} = -25.00 \text{ Hz}$$

Characteristic point 2:

$$X2 = [80,00\% \cdot (100,00\% - 20,00\%) + 20,00\%] \cdot 10 \text{ V} = 8.40 \text{ V}$$

$$Y2 = 85,00\% \cdot 50,00 \text{ Hz} = 42.50 \text{ Hz}$$

Tolerance band:

$$\Delta X = [2,00\% \cdot (100,00\% - 20,00\%) \cdot 10 \text{ V}] = 0.16 \text{ V}$$

The change of direction of rotation is done in the example at an analog input signal of 5.88 V, with a tolerance band of $\pm 0.16 \text{ V}$.

Operation mode "101 – bipolar abs. value"

The operation mode "101 – bipolar abs. value" maps the bipolar analog signal onto a unipolar input characteristic. The formation of the absolute value takes the characteristic into account comparable to the "bipolar" operation mode, but the characteristic points are reflected on the X axis with a negative value for the Y axis.

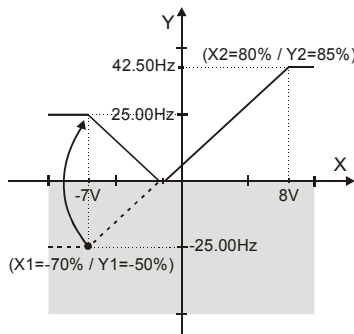

Characteristic point 1:

$$X1 = -70.00\% \cdot 10 \text{ V} = -7.00 \text{ V}$$

$$Y1 = -50.00\% \cdot 50.00 \text{ Hz} = -25.00 \text{ Hz}$$

Characteristic point 2:

$$X2 = 80.00\% \cdot 10 \text{ V} = 8.00 \text{ V}$$

$$Y2 = 85.00\% \cdot 50.00 \text{ Hz} = 42.50 \text{ Hz}$$

Tolerance band:

$$\Delta X = 2.00\% \cdot 10 \text{ V} = 0.20 \text{ V}$$

In this example, the reference value is again increased from an analog input signal of -1.44 V with a tolerance band of $\pm 0.20 \text{ V}$. The theoretical change of sign of the reference value is taken into account and leads to the tolerance band stated. There is no change of the direction of rotation.

5.1.5 Scaling

The analog input signal is mapped to the freely configurable characteristic. The maximum admissible setting range of the drive mechanism is to be set according to the configuration selected via the frequency limits or the percentage value limits. In the parameterization of a bipolar characteristic, the minimum and maximum limit for both directions of rotation are taken over. The percentage values of the characteristic points are relative to the maximum limits selected.

Parameter		Setting		
No.	Description	Min.	Max.	Fact. sett.
418	Minimum Frequency	0.00 Hz	999.99 Hz	3.50 Hz
419	Maximum Frequency	0.00 Hz	999.99 Hz	50.00 Hz

The controls use the maximum value of the output frequency, which is calculated from the parameter *maximum frequency* **419** and the compensated slip of the drive mechanism. The frequency limits define the speed range of the drive mechanism and the reference percentage values supplement the scaling of the input characteristic according to the configured functions.

Parameter		Setting		
No.	Description	Min.	Max.	Fact. sett.
518	Minimum reference percentage	0.00 %	300.00 %	0.00 %
519	Maximum reference percentage	0.00 %	300.00 %	100.00 %

5.1.6 Tolerance band and hysteresis

The analog input characteristic with change of sign of the reference value can be adapted by the parameter *Tolerance band* **560** of the application. The tolerance band to be defined extends the zero crossing of the speed relative to the analog control signal. The percentage parameter value is relative to the maximum current or voltage signal.

Parameter		Setting		
No.	Description	Min.	Max.	Fact. sett.
560	Tolerance band	0.00 %	25.00 %	2.00 %

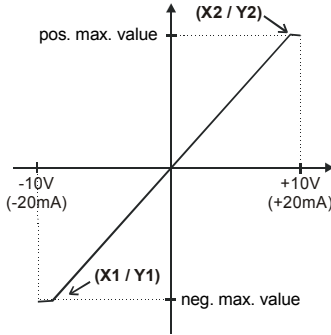

Without tolerance band

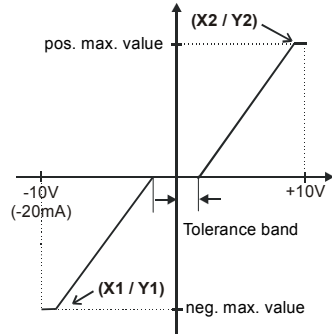

With tolerance band

The *Minimum Frequency* **418** or the *Minimum reference percentage* **518** set in the factory extend the parameterized tolerance band to the hysteresis.

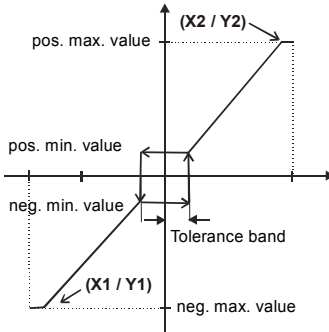

With tolerance band and minimum value

For example, the output variable coming from the positive input signals is kept at the positive minimum value until the input signal becomes smaller than the value for the tolerance band in a negative direction. Only then is there continuation on the set characteristic.

5.1.7 Error and warning behavior

The monitoring of the analog input signal necessary according to the application is to be configured via the parameter *Error/Warning behavior* **563**.

Operation mode	Function
0 -Off	The input signal is not monitored.
1 -Warning < 1 V / 2 mA	If the input signal is smaller than 1 V or 2 mA, there is a warning message.
2 -Shutdown < 1V / 2 mA	If the input signal is smaller than 1 V or 2 mA, there is a warning message, the drive mechanism is decelerated according to stopping behavior 2.
3 - Fault switch-off < 1 V / 2 mA	If the input signal is smaller than 1 V or 2 mA, there is a warning and fault message and the drive mechanism stops freely.

The monitoring of the analog input signal is active independent of the release of the frequency inverter according to the operation mode selected.

In operation mode **2**, the drive mechanism is decelerated independent of the stopping behavior set (Parameter *Operation mode* **630**) according to stopping behavior 2 (shutdown and stop). If the set holding time has expired, there is a fault message. A repeat start of the drive mechanism is possible by switching the start signal on and off if the fault has been rectified beforehand.

Operation mode **3** defines the free stoppage of the drive mechanism, independent of the stopping behavior selected, which is stipulated with the parameter *Operation Mode* **630**.

Attention! Monitoring of the analog input signal via the parameter *Error/Warning Behavior* **563** demands a check of the characteristic parameters.

5.1.8 Adjustment

As a result of component tolerances, it can be necessary to adjust the analog input. Parameter *Adjustment* **568** is used for this purpose.

Operation mode	Function
0 -no adjustment	Normal operation
1 -Adjustment 0 V / 0 mA	Adjustment of the measurement with an analog signal of 0 V or 0 mA.
2 -Adjustment 10 V / 20 mA	Adjustment of the measurement with an analog signal of 10 V or 20 mA.

Example of the adjustment of the analog input with a voltage signal:

Note: The measurements for the adjustment are to be done with a suitable measuring instrument and the correct polarity. If not, faulty measurements can result. If an external voltage source is used for the adjustment, make sure to set the voltage/current values exactly as these values are saved as 0 V/0 mA and 10 V/20 mA.

- Apply 0 V to the analog input; e.g. with a bridge from the terminal of the analog input X410B.3 to terminal X210B.7 (earth/GND) of the frequency inverter.
- Select operation mode "1 - Adjustment 0 V / 0 mA".
- Apply 10 V to the analog input, e.g. with a bridge from the terminal of the analog input to terminal X210B.5 (reference output 10 V) of the frequency inverter.
- Select operation mode "2 - Adjustment 10 V / 20 mA".

This completes the adjustment of the analog input.

5.1.9 Filter time constant

The time constant of the filter for the reference analog value can be set via the parameter *Filter time constant* **561**.

The time constant states the time for which the input signal is averaged by means of a low pass, e.g. in order to eliminate fault effects.

The setting range is a range of values between 0 ms and 5000 ms in 15 steps.

Operation mode	Function
0 -Time constant 0 ms	Filter deactivated – analog reference value is forwarded unfiltered
2 -Time constant 2 ms	Filter activated – averaging of the input signal via the set value of the filter time constants
4 -Time constant 4 ms	
8 -Time constant 8 ms	
16 -Time constant 16 ms	
32 -Time constant 32 ms	
64 -Time constant 64 ms	
128 -Time constant 128 ms	
256 -Time constant 256 ms	
512 -Time constant 512 ms	
1000 -Time constant 1000 ms	
2000 -Time constant 2000 ms	
3000 -Time constant 3000 ms	
4000 -Time constant 4000 ms	
5000 -Time constant 5000 ms	

5.2 Analog output EM- S1OUTA (voltage output)

5.2.1 General

The analog output 1 of the EM-IO-03 expansion module is a voltage output with a range of ± 10 V. Parameterization of the output signals is done by the definition of the operation mode and a linear characteristic, stating the offset and the amplification.

5.2.2 Operation modes

The operation mode of the analog output is selected via the parameter *Operation mode* **584**.

Alongside the operation modes listed, those stated in the operating instructions of the frequency inverter in the chapter "Analog output MFO1A" also apply.

Operation mode	Function
0 -Off	Analog output switched off, 0 V fixed voltage for the adjustment
41 -Abs. value EM-S1INA	Abs. value of signal on the analog input EM-S1INA, between 0.0 V...10.0 V
100 -10 V	10 V fixed voltage for the adjustment
101 to 133, 141	Operation modes 1 to 33 and 41 with sign, between -10 V...10 V
201 to 254	Operation modes 1 to 54; Actual abs. value between 2 V...10 V

5.2.3 Adjustment

As a result of component tolerances, it can be necessary to adjust the analog output. Parameter *Adjustment* **587** is used for this purpose.

No.	Parameter	Setting		
	Description	Min.	Max.	Fact. sett.
587	Adjustment	-15.00 V	15.00 V	0.00 V

Example of the adjustment of the analog output:

Note: The measurements for the adjustment are to be done with a suitable measuring instrument and the correct polarity.
The order shown in the example is to be complied with during the adjustment.
If not, faulty measurements and settings can result.

- Select operation mode "0 – Off" for the parameter *Operation mode* **584**.
- Enter the voltage measured on the output in the parameter *Adjustment* **587**.
- Select operation mode "100 - 10 V" for parameter *Operation mode* **584**.
- Enter the voltage measured on the output in the parameter *Adjustment* **587**.
- Select operation mode "0 – Off" on the parameter *Operation mode* **584**. In case the voltage measured at the output deviates from 0 V significantly, carry out the adjustment procedure again.

Note: The greatest precision to be achieved is approx. ± 40 mV.

- Select the required operation mode of the analog output for parameter *Operation mode* **584**.

5.2.4 Zero adjustment and amplification

After the adjustment has been carried out, the voltage of the output signal at 0% and 100% of the reference signals can be set with the parameters *Offset* **585** (zero adjustment) and *Amplification* **586**.

The zero adjustment with the parameter *Offset* **585** is done specific to the application as a percentage of the final value of the analog output (10 V).

Via the parameter *Amplification* **586** the amplification can be set as a percentage of the final value of the analog output (10 V).

In the factory setting, the zero point has been set at 0% Offset, i.e. minimum value of the reference signal equal to 0 V output signal. The factory setting amplification equal to 100% means that the output signal is 10 V when the reference value is reached.

Parameter		Setting		
No.	Description	Min.	Max.	Fact. sett.
585	Offset	-100.00 %	100.00 %	0.00 %
586	Amplification	5.0 %	1000.0 %	100.0%

5.2.4.1 Examples

The actual value parameter is mapped to the analog output signal as a function of the selected parameters *Offset* **585** and *Amplification* **586**. The following examples show the application-specific adaptation for an analog voltage signal.

Example 1:

Parameter		Setting
No.	Description	Example
585	Offset	0.00 %
586	Amplification	1000.0 %

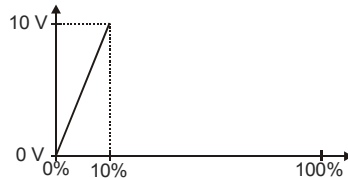

The setting of the parameter *Offset* **585** to 0.00% and the parameter *Amplification* **586** to 1000.0% means that the output signal:

- is 0 V at 0% of the reference signal,
- is 10 V at 10% of the reference signal.

Example 2:

Parameter		Setting
No.	Description	Example
585	Offset	-5.00 %
586	Amplification	100.0 %

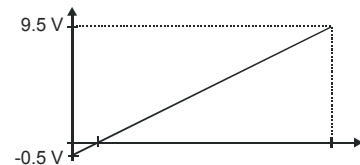

The setting of the parameter *Offset* **585** to -5,00% and the parameter *Amplification* **586** to 100.0% means that the output signal:

- is -0.5 V at 0% of the reference signal,
- is 9.5 V at 100% of the reference signal.

5.3 Analog output EM- S2OUTA (current output)

5.3.1 General

The analog output 2 of the EM-IO-03 expansion module is a current output with a range of 0(4)...20 mA. Parameterization of the output signals is done by the definition of the operation mode and a linear characteristic, stating the offset and the amplification.

5.3.2 Operation modes

The operation mode of the analog output is selected via the parameter *Operation mode* **525**.

Additional to the operation modes listed, those stated in the operating instructions of the frequency inverter in the chapter "Analog output MFO1A" also apply.

Operation mode	Function
0 -Off	Analog output switched off; 0 mA current for the adjustment
41 analog value EM-S1INA, abs. value	abs. value of signal on the analog input EM-S1INA, between 0.0 mA...20.0 mA
100 -20 mA	20 mA current for the adjustment
201 to 254	Operation modes 1...54; Act. absolute value between 4 mA...20 mA

5.3.3 Adjustment

As a result of component tolerances, it can be necessary to adjust the analog output. Parameter *Adjustment* **528** is used for this purpose.

Parameter		Setting		
No.	Description	Min.	Max.	Fact. sett.
528	Adjustment	-10.00 mA	30.00 mA	0.00 mA

Example of the adjustment of the analog output:

Note: The measurements for the adjustment are to be done with a suitable measuring instrument and the correct polarity.
The order shown in the example is to be complied with during the adjustment.
If not, faulty measurements and settings can result.

- Select operation mode "0 – Off" for the parameter *Operation mode* **525**.
- Enter the current measured on the output in the parameter *Adjustment* **528**.
- Select operation mode "100 -20 mA" for parameter *Operation mode* **525**.
- Enter the current measured on the output in the parameter *Adjustment* **528**.
- Select operation mode "0 – Off" for the parameter *Operation mode* **525**. In case the current measured at the output deviates from 0 mA significantly, carry out the adjustment procedure again.

Note: The greatest precision to be achieved is approx. +/-16 µA.

- Select the required operation mode of the analog output for parameter *Operation mode* **525**.

5.3.4 Zero adjustment and amplification

After the adjustment has been carried out, the current of the output signal at 0% and 100% of the reference signals can be set with the parameters *Offset* **526** (zero adjustment) and *Amplification* **527**.

The zero adjustment with the parameter *Offset* **526** is done specific to the application as a percentage of the final value of the analog output (20 mA).

Via the parameter *Amplification* **527** the amplification can be set as a percentage of the final value of the analog output (20 mA).

In the factory setting, the zero point has been set at 0% Offset, i.e. minimum value of the reference signal equal to 0 mA output signal. The factory setting amplification equal to 100 % means that the output signal is 20 mA when the reference value is reached.

Parameter		Setting		
No.	Description	Min.	Max.	Fact. sett.
526	Offset	-100.00 %	100.00 %	0.00 %
527	Amplification	5.0 %	1000.0 %	100.0%

5.3.4.1 Examples

Example 1:

Parameter		Setting
No.	Description	Example
526	Offset	0.00 %
527	Amplification	1000.0 %

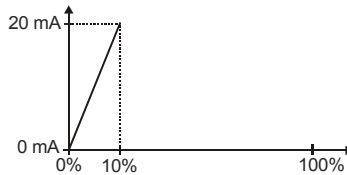

The setting of the parameter *Offset* **526** to 0.00% and the parameter *Amplification* **527** to 1000.0% means that the output signal:

- is 0 mA at 0% of the reference signal and
- is 20 mA at 10% of the reference signal.

Example 2:

Parameter		Setting
No.	Description	Example
526	Offset	-5.00 %
527	Amplification	100.0 %

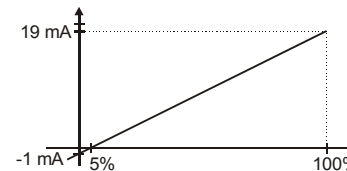

The setting of the parameter *Offset* **526** to -5,00% and the parameter *Amplification* **527** to 100,0% means that the output signal:

- is -1 mA at 0% of the reference signal and
- is 19 mA at 100% of the reference signal.

5.4 Digital output EM-S1OUTD

5.4.1 General

The digital output of the EM-IO-03 expansion module is designed as a relay make contact. Parameterization of this digital output permits a linking to a variety of functions. The selection of functions depends on the parameterized configuration.

5.4.2 Operation modes

The operation mode of the digital output (Terminals X410A.6 and 7) is selected via the parameter *Operation Mode EM-S1OUTD* **533**.

The selectable operation modes correspond to the table shown in the operating instructions of the frequency inverter in the chapter "Digital outputs".

5.5 Digital inputs EMS2IND and EMS3IND

The EM-IO-03 expansion module has two digital inputs. The assignment of the control signals to the available software functions can be adapted to the application in question. As a function of the selected *Configuration* **30**, the factory-set assignment and the selection of the operation mode differ. In addition to the digital control inputs available, further internal logistic signals are also available as sources.

The individual software functions are assigned to the various signal sources via parameterization-capable inputs. This enables a flexible and varied use of the digital control signals.

Operation mode	Function
321 -EM-S2IND	Signal on digital input 2 (X410A.4)
322 -EM-S3IND	Signal on digital input 3 (X410A.5)
521 -EM-S2IND inverted	Inverted signal on digital input 2 (X410A.4)
522 -EM-S3IND inverted	Inverted signal on digital input 3 (X410B.5)

Alongside the operation modes listed, those stated in the operating instructions of the frequency inverter in the chapter "Digital inputs" also apply.

5.5.1 Fixed reference values and fixed value switch-over

As a function of the *Reference Frequency Source* **475** selected, fixed frequencies can be used as reference values. The EM-IO-03 expansion module extends the functionality described in the operating instructions of the frequency inverter (parameter *Fixed frequency change-over 1* **66** and *Fixed frequency change-over 2* **67**) by the parameter *Fixed frequency change-over 3* **131** and the matching parameters *Fixed frequency 5* **485**, *Fixed frequency 6* **486**, *Fixed frequency 7* **487**, *Fixed frequency 8* **488**.

	Activation Fixed frequencies		
	<i>Fixed frequency change-over 1</i> 66	<i>Fixed frequency change-over 2</i> 67	<i>Fixed Frequency change-over 3</i> 131
<i>Fixed frequency 1</i> 480	0	0	0
<i>Fixed frequency 2</i> 481	1	0	0
<i>Fixed frequency 3</i> 482	1	1	0
<i>Fixed frequency 4</i> 483	0	1	0
<i>Fixed frequency 5</i> 485	0	1	1
<i>Fixed frequency 6</i> 486	1	1	1
<i>Fixed frequency 7</i> 487	1	0	1
<i>Fixed frequency 8</i> 488	0	0	1

5.6 Digital inputs for speed sensor 2

The digital inputs EM-S2IND and EM-S3IND of the EM-IO-03 expansion module can be set via the parameter *Operation mode Speed sensor 2* **493** and selection of the corresponding operation mode for the evaluation of a unipolar 24V two-channel speed sensor (incremental speed sensor).

Assignment of the inputs:

- Digital input EM-S2IND: track A
- Digital input EM-S3IND: track B

With the help of parameter *Operation mode Speed sensor 2* **493**, the following operation modes are available:

Operation mode	Function
0 -Off	Speed measurement not active The digital inputs are available for further functions.
4 -Quadruple evaluation	Two-channel speed sensor with recognition of direction of rotation via track signals A and B; four signal edges are evaluated per division mark.
104 -Quadruple evaluation inverted	Like operation mode 4; the actual speed value is inverted (alternatively to the exchange of the track signals).

5.6.1 Division marks speed sensor 2

The number of increments of the connected speed sensor can be adjusted via the parameter *Division marks speed sensor 2* **494**. The number of division marks of the speed sensor is to be selected according to the speed range of the application. The maximum number of division marks S_{\max} is defined by the limit frequency of $f_{\max} = 150$ kHz of the digital inputs EM-S2IND (track A) and EM-S3IND (track B).

$$S_{\max} = 150000 \text{ Hz} \cdot \frac{60 \text{ s / min}}{n_{\max}} \quad n_{\max} = \text{Max. speed of the motor in RPM}$$

To ensure a good true running of the drive mechanism, a sensor signal must be evaluated at least every 2 ms (signal frequency $f = 500$ Hz). The minimum number of division marks S_{\min} of the incremental speed sensor for a required minimum speed n_{\min} can be calculated from this requirement. The evaluation of four signal edges per mark is firmly defined in the function of speed sensor 2.

$$S_{\min} = 500 \text{ Hz} \cdot \frac{60 \text{ s / min}}{A \cdot n_{\min}} \quad \begin{array}{l} n_{\min} = \text{Min. speed of the motor in RPM} \\ A = 4 \text{ (quadruple evaluation)} \end{array}$$

Parameter		Setting		
No.	Description	Min.	Max.	Fact. Sett.
494	Division marks speed sensor 2	1	8192	1024

5.6.2 Actual speed source

If speed sensor 2 of the expansion module is to deliver the actual value signal for the speed controller, speed sensor 2 must be selected as the source. Switch-over is effected via parameter *Actual Speed Source* **766**. By default, speed sensor 1 is used as the actual speed source.

Operation mode	Function
1 -Speed sensor 1	The actual speed source is speed sensor 1 of the basic device (factory setting).
2 -Speed sensor 2	The actual speed source is speed sensor 2 of the EM-IO-03 expansion module.

5.6.3 Actual value comparison

The expansion module provides additional operation modes for parameters *Operation Mode Comparator 1* **540** and *Operation Mode Comparator 2* **543** which are described in the operating instructions. These operation modes enable the comparison of the speed of speed sensor 2 and the analog input EM-S1INA to the maximum speed and the maximum analog input value, respectively.

Operation mode	Function
8 -Abs. Actual speed 2	<i>Speed Sensor 2 Speed</i> 220 > maximum speed (calculated from <i>Maximum Frequency</i> 419 and <i>No. of Pole Pairs</i> 373)
16 Analog input EM-S1INA abs. Value	<i>Analog input EM-S1INA</i> 253 > analog input 100%
108 and 116	Operation modes with signs (+/-)

5.7 Frequency and percentage reference channel

The varied functions for the specification of the reference values are connected in the various configurations by the frequency or percentage reference channel. The *Reference frequency source 475*, and the *Reference percentage source 476* determine the additive connection of the available reference sources as a function of the installed hardware.

Operation mode		Function
2 -	Abs. Value EM-S1INA	Reference source is the analog input EM-S1INA.
4 -	Abs. Value, MFI1A + EM-S1INA	Reference sources are the multifunctional input MFI1A and the analog input EM-S1INA.
12 -	Abs. Value, EM-S1INA + FF (and/or FP)	Reference sources are the analog input EM-S1INA and fixed frequency FF (and/or the fixed percentage FP)
14 -	Abs. Value, MFI1A + EM-S1INA + FF (and/or FP)	Reference sources are the multifunctional input MFI1A, analog input EM-S1INA and fixed frequency FF (and/or the fixed percentage FP)
22 -	Abs. Value EM-S1INA + MP	Reference sources are the analog input EM-S1INA and the motor potentiometer function MP.
24 -	Abs. Value, MFI1A + EM-S1INA + MP	Reference sources are the multifunctional input MFI1A, analog input EM-S1INA and the motor potentiometer function MP.
34 -	Abs. Value, speed sensor 2 (F2)	The frequency signals in <i>Operation mode Speed sensor 2 493</i> are evaluated as a reference value.
35 -	Abs. Value MFI1A + F2	Reference sources are the multifunctional input MFI1A and the frequency signals in <i>Operation Mode Speed Sensor 2 493</i> .
102 to 135		Operation modes with signs (+/-)

Alongside the operation modes listed, those stated in the operating instructions of the frequency inverter in the chapter "Frequency reference channel", and in the chapter "Percentage reference channel" also apply.

5.8 Actual value display

The actual values of speed sensor 2 can be read via the parameters *Frequency speed sensor 2 219* and *Speed, speed sensor 2 220*.

The analog input signal on analog input EM-S1INA can be a voltage or a current signal depending on the setting of switch **S3**. Accordingly, the actual value parameter *analog input EM-S1INA 253* is displayed as a percentage.

The analog output signal on analog output EM-S1OUTA can be read via the actual value parameter *Analog output EM-S1OUTA 266*.

The analog output signal on analog output EM-S2OUTA can be read via the actual value parameter *Analog output EM-S2OUTA 268*.

5.9 Status of the digital signals

The status of the digital signals can be read in decimal coding via the parameters *Digital inputs 250* and *Digital outputs 254*. The display of the digital input signals enables checking the various control signals and their connections with the software functions in question, in particular in commissioning.

After conversion of the decimal figure into the binary system, bits 9 and 10 display the states of the inputs EM-S2IND and EM-S3IND.

Coding of the status of the digital signals

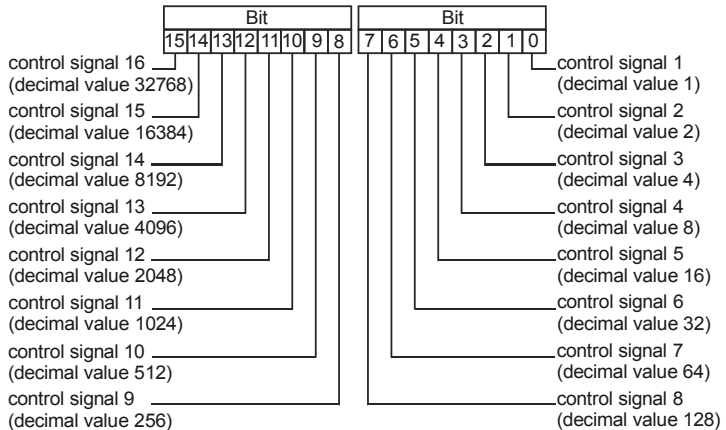

Example:

The actual value parameter *Digital inputs 250* displays the decimal value **640**. After conversion into the binary system, the following combination results:

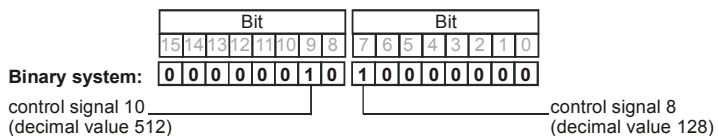

The following status of the digital input signals of the EM-IO-03 expansion module has been displayed.

- Digital input EM-S2IND = 0 – control signal 9
- Digital input EM-S3IND = 1 – control signal 10

Note:

The two digital inputs of the EM-IO-03 expansion module can be used for the evaluation of a speed sensor via the parameter *Operation mode Speed sensor 2 493*. The control signals are set to the logical value zero as a function of the selected operation mode.

5.10 Motor temperature

Temperature monitoring forms part of the configurable fault and alarm behavior. The connected load can be monitored by connecting a measuring resistor (motor PTC) with temperature characteristics according to DIN 44081 or by means of a bimetal temperature sensor (break contact).

The operation mode of the motor ptc port can be selected via parameter *Operation Mode Motor temp.* **570** The operation modes described in chapter "Motor Temperature" of the frequency inverter operating instructions are complemented by the following operation modes with the EM-IO-03 expansion module:

Operation mode	Function
11 -EM-MPTC: warning only	The critical operating point is displayed by the control unit and parameter <i>Warnings</i> 269 .
12 -EM-MPTC: Error-switch-off	Error-switch-off is displayed by message F0400. Error-switch-off can be acknowledged via the control unit or the digital input.
13 -Error-switch-off, 1 min. delay	Error-switch-off according to operation mode 2, delayed by one minute.
14 -Error-switch-off, 5 min. delay	Error-switch-off according to operation mode 2, delayed by five minutes.
15 -Error-switch-off, 10 min. delay	Error-switch-off according to operation mode 2, delayed by ten minutes.

The function to be adjusted by parameter *Operation Mode Motor Temp.* **570** results in signaling the overtemperature by the red LED of the frequency inverter, irrespective of the selected operation modes of the control inputs and outputs.

The operation modes with error-switch-off result in the fault message "FAULT" with fault number "F0400" being displayed on the control unit KP500.

The fault message can be acknowledged via parameter *Program* **34** or the logic signal linked with parameter *Error Acknowledgement* **103**.

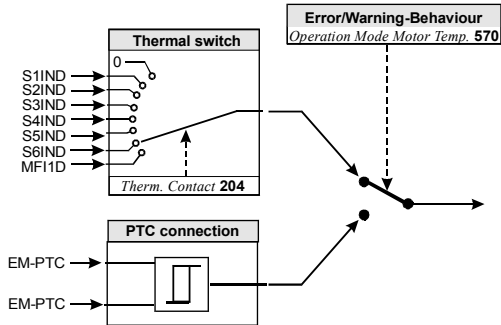

The function selected according to the above table with parameter *Operation mode Motor Temp.* **570** can be linked, as required, to the digital control outputs and the warning mask. (For detailed information, refer to the operating instructions of the frequency inverter).

Note: The evaluation of the motor PTC port is independent of the signal at the digital controller input S11IND (controller release).

The motor temperature for a temperature adjustment, as described in chapter "Temperature Adjustment", can be effected via analog input EM-S1INA. The selection is effected via parameter *Operation Mode* **465**.

Operation mode	Function
2_Temp. meas. at EM-S1INA	Temperature synchronization (0 ... 200 °C => 0...10 V / 0...20 mA), Act. temperature value at analog input of EM-IO-03 expansion module.

6 Parameter list









The parameter list is structured according to the menu branches of the control unit. For better clarity, the parameters are marked with pictograms:

-  The parameter is available in the four data sets.
- The parameter value is set by the SETUP routine.
- This parameter cannot be written in the operation of the frequency inverter.

6.1 Actual value menu (VAL)

Actual values of the machine				
No.	Description	Unit	Display range	Chapter
219	Frequency speed sensor 2	Hz	0.0 ... 999.99	5.8
220	Speed, speed sensor 2	rpm	0 ... 60000	5.8
Actual values of the frequency inverter				
250	Digital inputs	-	00 ... 32767	5.9
253	Analog input EM-S1INA	%	-100 ... +100	5.8
254	Digital outputs	-	00 ... 32767	5.9
266	Analog output EM- S1OUTA	V	-10.0 ... +10.0	5.8
268	Analog output EM- S2OUTA	mA	0.0 ... 20.0 mA	5.8
Actual values of the system bus				
978	Node-State	-	1 ... 3	4.12
979	CAN-State	-	1 ... 3	4.12

6.2 Parameter menu (PARA)

Digital input					
No.	Description	Unit	Setting range	Chapter	
131	Fixed Frequency change-over 3	-	Selection	5.5.1	
Speed sensor 2					
<input checked="" type="checkbox"/>	493	Operation mode speed sensor 2	-	Selection	5.6
<input checked="" type="checkbox"/>	494	Division marks speed sensor 2	-	1 ... 8192	5.6.1
Fixed frequencies					
	485	Fixed frequency 5	Hz	-999.99 ... 999.99	5.5.1
	486	Fixed frequency 6	Hz	-999.99 ... 999.99	5.5.1
	487	Fixed frequency 7	Hz	-999.99 ... 999.99	5.5.1
	488	Fixed frequency 8	Hz	-999.99 ... 999.99	5.5.1
Digital outputs					
	533	Operation mode EM-S1OUTD	-	Selection	5.4.2
Analog input EM-S1INA					
	560	Tolerance band	%	0.00 ... 25.00	5.1.6
	561	Filter time constant	ms	Selection	5.1.9
	562	Operation mode	-	Selection	5.1.4
	563	Error/warning behavior	-	Selection	5.1.7
	564	Characteristic point X1	%	-100.00 ... 100.00	5.1.3
	565	Characteristic point Y1	%	-100.00 ... 100.00	5.1.3
	566	Characteristic point X2	%	-100.00 ... 100.00	5.1.3
	567	Characteristic point Y2	%	-100.00 ... 100.00	5.1.3
	568	Adjustment	-	Selection	5.1.8

List of parameters continued on next page

Motor PTC Resistor Connection EM-MPTC				
No.	Description	Unit	Setting range	Chapter
570	Operation mode motor temp.	-	Selection	5.10
Analog output 1 EM-S1OUTA				
584	Operation mode	-	Selection	5.2.2
585	Offset	%	-100.00 ... 100.00	5.2.4
586	Amplification	%	5.0 ... 1000.0	5.2.4
587	Adjustment	V	-15.00 ... +15.00	5.2.3
Analog output 2 EM-S2OUTA				
525	Operation mode	-	Selection	5.3.2
526	Offset	%	-100.00 ... 100.00	5.3.4
527	Amplification	%	5.0 ... 1000.0	5.3.4
528	Adjustment	mA	-10.00 ... +30.00	5.3.3
Speed controller				
766	Actual speed source	-	Selection	5.6.2
System bus				
900	Node-ID	-	-1 ... 63	4.5
903	Baud-Rate	-	3 ... 8	4.4
904	Boot-Up Delay	ms	3500 ... 50000	4.8.4
918	SYNC-Identifier	-	0 ... 2047	4.8.2
919	SYNC-Time	ms	0 ... 50000	4.9.2
921	RxSDO1-Identifier	-	0 ... 2047	4.9.4
922	TxSDO1-Identifier	-	0 ... 2047	4.9.4
923	SDO2 Set Active	-	0 ... 1	4.9.4
924	RxPDO1-Identifier	-	0 ... 2047	4.11.1
925	TxPDO1-Identifier	-	0 ... 2047	4.11.1
926	RxPDO2-Identifier	-	0 ... 2047	4.11.1
927	TxPDO2-Identifier	-	0 ... 2047	4.11.1
928	RxPDO3-Identifier	-	0 ... 2047	4.11.1
929	TxPDO3-Identifier	-	0 ... 2047	4.11.1
930	TxPDO1 Function	-	0 ... 2	4.11.2
931	TxPDO1 Time	ms	0 ... 50000	4.11.2
932	TxPDO2 Function	-	0 ... 2	4.11.2
933	TxPDO2 Time	ms	0 ... 50000	4.11.2
934	TxPDO3 Function	-	0 ... 2	4.11.2
935	TxPDO3 Time	ms	0 ... 50000	4.11.2
936	RxPDO1 Function	-	0 ... 1	4.11.2
937	RxPDO2 Function	-	0 ... 1	4.11.2
938	RxPDO3 Function	-	0 ... 1	4.11.2
939	SYNC Timeout	ms	0 ... 60000	4.11.3
941	RxPDO1 Timeout	ms	0 ... 60000	4.11.3
942	RxPDO2 Timeout	ms	0 ... 60000	4.11.3
945	RxPDO3 Timeout	ms	0 ... 60000	4.11.3
946	TxPDO1 Boolean1	-	0 ... 999	4.11.5.1
947	TxPDO1 Boolean2	-	0 ... 999	4.11.5.1
948	TxPDO1 Boolean3	-	0 ... 999	4.11.5.1
949	TxPDO1 Boolean4	-	0 ... 999	4.11.5.1
950	TxPDO1 Word1	-	0 ... 999	4.11.5.1
951	TxPDO1 Word2	-	0 ... 999	4.11.5.1
952	TxPDO1 Word3	-	0 ... 999	4.11.5.1
953	TxPDO1 Word4	-	0 ... 999	4.11.5.1
954	TxPDO1 Long1	-	0 ... 999	4.11.5.1
955	TxPDO1 Long2	-	0 ... 999	4.11.5.1

List of parameters continued on next page

System bus				
No.	Description	Unit	Setting range	Chapter
956	TxPDO2 Boolean1	-	0 ... 999	4.11.5.1
957	TxPDO2 Boolean2	-	0 ... 999	4.11.5.1
958	TxPDO2 Boolean3	-	0 ... 999	4.11.5.1
959	TxPDO2 Boolean4	-	0 ... 999	4.11.5.1
960	TxPDO2 Word1	-	0 ... 999	4.11.5.1
961	TxPDO2 Word2	-	0 ... 999	4.11.5.1
962	TxPDO2 Word3	-	0 ... 999	4.11.5.1
963	TxPDO2 Word4	-	0 ... 999	4.11.5.1
964	TxPDO2 Long1	-	0 ... 999	4.11.5.1
965	TxPDO2 Long2	-	0 ... 999	4.11.5.1
966	TxPDO3 Boolean1	-	0 ... 999	4.11.5.1
967	TxPDO3 Boolean2	-	0 ... 999	4.11.5.1
968	TxPDO3 Boolean3	-	0 ... 999	4.11.5.1
969	TxPDO3 Boolean4	-	0 ... 999	4.11.5.1
972	TxPDO3 Word1	-	0 ... 999	4.11.5.1
973	TxPDO3 Word2	-	0 ... 999	4.11.5.1
974	TxPDO3 Word3	-	0 ... 999	4.11.5.1
975	TxPDO3 Word4	-	0 ... 999	4.11.5.1
976	TxPDO3 Long1	-	0 ... 999	4.11.5.1
977	TxPDO3 Long2	-	0 ... 999	4.11.5.1
989	Emergency Reaction	-	0 ... 1	4.8.3

7 Annex

7.1 Error messages

The various control functions and methods and the hardware of the frequency inverter contain functions which continuously monitor the application. As a supplement to the messages documented in these operating instructions, the following failure keys are activated by the EM-IO-03 expansion module.

Control connections		
F14	02	Reference value signal on analog input EM-S1INA faulty, check signal.
	30	Speed sensor signal 2 is faulty, check connections
	31	One track of the speed sensor signal 2 is missing, check connections.
	32	Direction of rotation of speed sensor 2 wrong, check connections.
	33	Speed sensor 2, divisions marks wrong, check speed sensor
	34	Division marks of speed sensor signal 2 too low, check speed sensor.
	35	Division marks of speed sensor signal 2 too high, check speed sensor.

System bus		
F21	nn	Fault report to system bus master in fault in system bus slave nn = Node ID of slave (hex)

System bus		
F22	00	Communication fault, system bus, timeout SYNC telegram
	01	Communication fault, system bus, timeout RxPDO1
	02	Communication fault, system bus, timeout RxPDO2
	03	Communication fault, system bus, timeout RxPDO3
	10	Communication fault, system bus, bus OFF

Alongside the fault messages stated, there are further fault messages, however they are only used for internal purposes and are not listed here. If you receive fault messages which are not listed here, please contact us by phone.



power, control and green solutions

Bonfiglioli has been designing and developing innovative and reliable power transmission and control solutions for industry, mobile machinery and renewable energy applications since 1956.

www.bonfiglioli.com

Bonfiglioli Riduttori S.p.A.
Via Giovanni XXIII, 7/A
40012 Lippo di Calderara di Reno
Bologna, Italy

tel: +39 051 647 3111
fax: +39 051 647 3126
bonfiglioli@bonfiglioli.com
www.bonfiglioli.com

VEC 219 R1