

**RoHS** RoHS-Compliant

2-Phase Stepping Motor & Driver Package

## RBK-Series

Microstep Drive

High-Torque Type  56.4 mm

Standard Type  56.4 mm,  85 mm



### Product Number Code

● RBK Series

**RBK2 6 4 P B**  
 ①      ②   ③   ④   ⑤

①	Series	<b>RBK: RBK Series</b>
②	Motor Frame Size	<b>6:</b> <input type="checkbox"/> 56.4 mm <b>9:</b> <input type="checkbox"/> 85 mm
③	Motor Case Length	
④	Motor Type	<b>P:</b> High-Torque Type Blank: Standard Type
⑤	Shaft Type	<b>A:</b> Single Shaft <b>B:</b> Double Shaft

● PK-Series

**PK2 6 4 P D B**  
 ①      ②   ③   ④   ⑤   ⑥

①	Series	<b>PK: PK Series</b>
②	Motor Frame Size	<b>6:</b> <input type="checkbox"/> 56.4 mm <b>9:</b> <input type="checkbox"/> 85 mm
③	Motor Case Length	
④	Motor Type	<b>P:</b> High-Torque Type Blank: Standard Type
⑤	Motor Lead	<b>D:</b> 4 Leads (4 Pins)
⑥	Shaft Type	<b>A:</b> Single Shaft <b>B:</b> Double Shaft

### Product lineup

Frame Size (mm)	Model		Motor Model		Driver Model	Cable Model
	Single shaft	Double shaft	Single shaft	Double shaft		
<input type="checkbox"/> 56.4 High-Torque Type	<b>RBK264PA</b>	<b>RBK264PB</b>	PK264PDA	PK264PDB	RBD228A-K	LC2B06C
	<b>RBK266PA</b>	<b>RBK266PB</b>	PK266PDA	PK266PDB		
	<b>RBK268PA</b>	<b>RBK268PB</b>	PK268PDA	PK268PDB		
<input type="checkbox"/> 56.4 Standard Type	<b>RBK264A</b>	<b>RBK264B</b>	PK264DA	PK264DB	RBD242A-V	
	<b>RBK266A</b>	<b>RBK266B</b>	PK266DA	PK266DB		
	<b>RBK268A</b>	<b>RBK268B</b>	PK268DA	PK268DB		
<input type="checkbox"/> 85 Standard Type	<b>RBK296A</b>	<b>RBK296B</b>	PK296DA	PK296DB	RBD245A-V	
	<b>RBK299A</b>	<b>RBK299B</b>	PK299DA	PK299DB		
	<b>RBK2913A</b>	<b>RBK2913B</b>	PK2913DA	PK2913DB		

## ■ Specifications

### ● High-Torque Type: Motor Frame Size 56.4 mm

Model	Single Shaft		RBK264PA	RBK266PA	RBK268PA
	Double Shaft		RBK264PB	RBK266PB	RBK268PB
Maximum Holding Torque	N·m		0.6	1.4	2.3
Rotor Inertia	J:kg·m <sup>2</sup>		120 × 10 <sup>-7</sup>	290 × 10 <sup>-7</sup>	490 × 10 <sup>-7</sup>
Rated Current	A/Phase		2.8		
Basic Step Angle			1.8°		
Power Source			20~40 VDC 3.7A		
Excitation Mode			Microstep		
Mass	Motor	kg	0.46	0.73	1.1
	Driver	kg	0.35		

## ■ Speed – Torque Characteristics

### ● 24 VDC Input

#### RBK264PA/RBK264PB

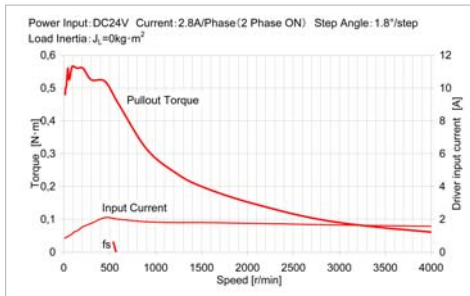

#### RBK266PA/RBK266PB

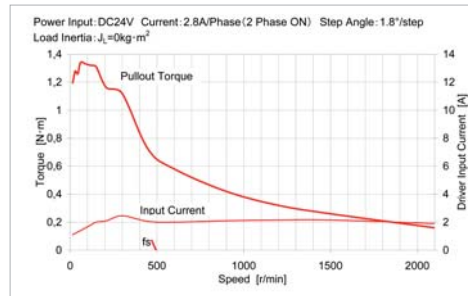

#### RBK268PA/RBK268PB

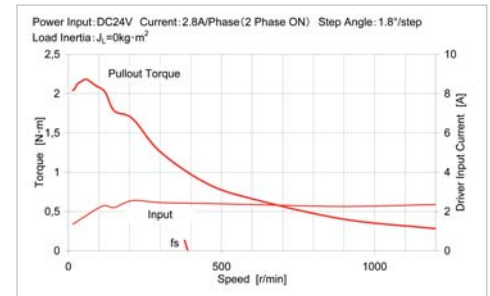

### ● 36 VDC Input

#### RBK264PA/RBK264PB

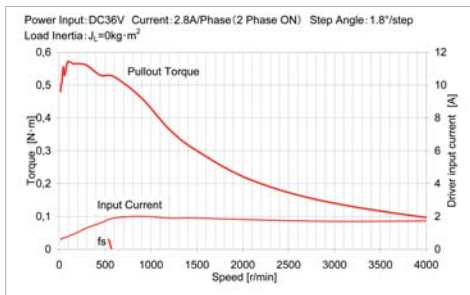

#### RBK266PA/RBK266PB

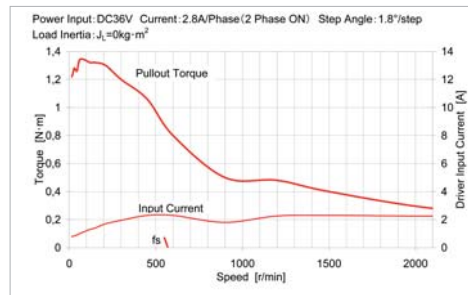

#### RBK268PA/RBK268PB



## ● Standard Type: Motor Frame Size 56.4 mm

Model	Single Shaft		RBK264A	RBK266A	RBK268A
	Double Shaft		RBK264B	RBK266B	RBK268B
Maximum Holding Torque	N·m		0.48	1.17	1.75
Rotor Inertia	J:kg·m <sup>2</sup>		120 × 10 <sup>-7</sup>	300 × 10 <sup>-7</sup>	480 × 10 <sup>-7</sup>
Rated Current	A/Phase		4.2		
Basic Step Angle			1.8°		
Power Source			20~75 VDC 4.9A		
Excitation Mode			Microstep		
Mass	Motor	kg	0.45	0.7	1
	Driver	kg	0.35		

## ■ Speed – Torque Characteristics

### ● 24 VDC Input

**RBK264A/RBK264B**

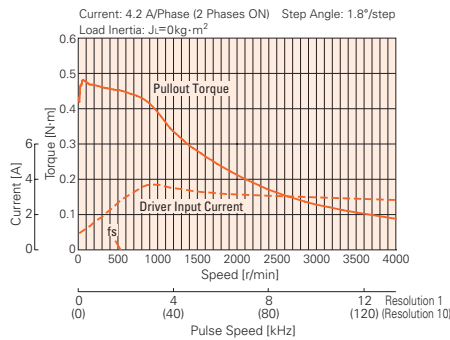

**RBK266A/RBK266B**

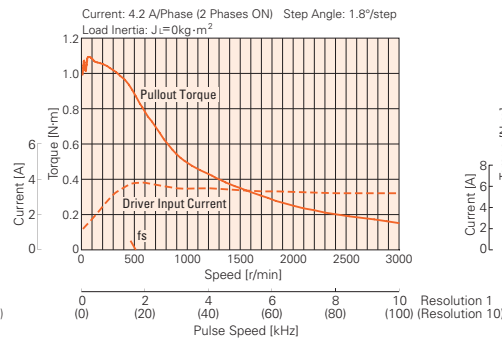

**RBK268A/RBK268B**

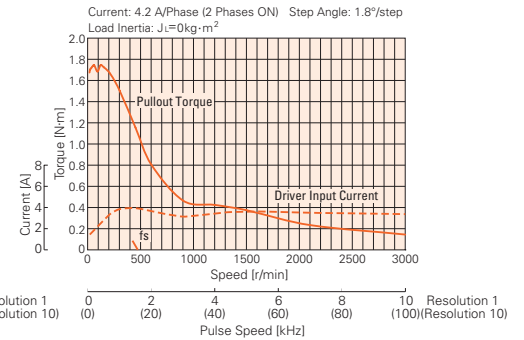

### ● 48 VDC Input

**RBK264A/RBK264B**

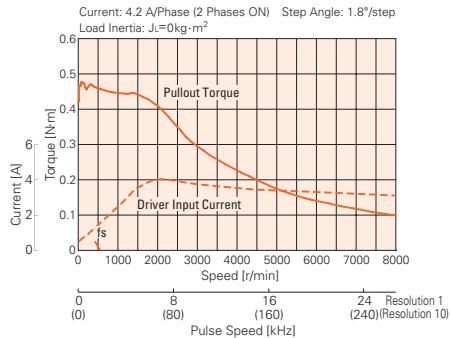

**RBK266A/RBK266B**

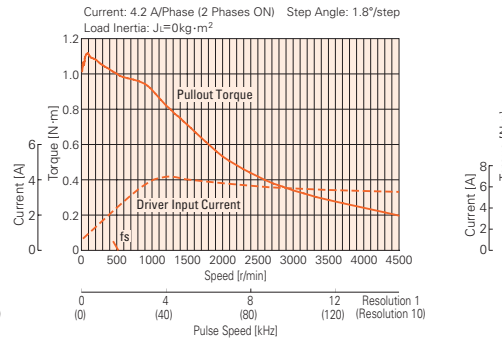

**RBK268A/RBK268B**

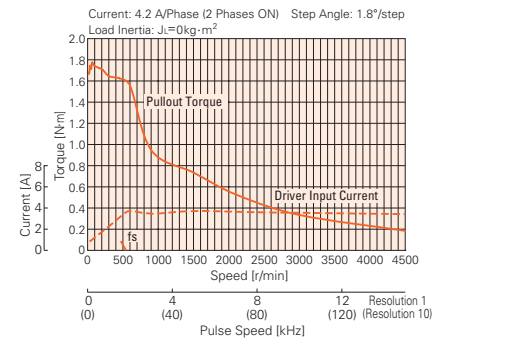

### ● 75 VDC Input

**RBK264A/RBK264B**

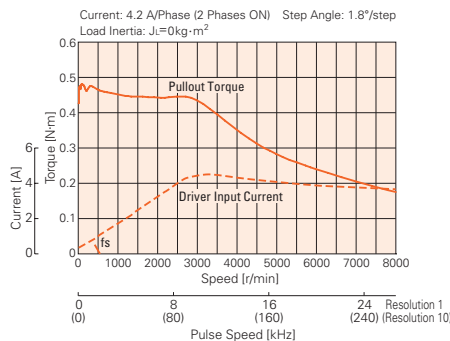

**RBK266A/RBK266B**

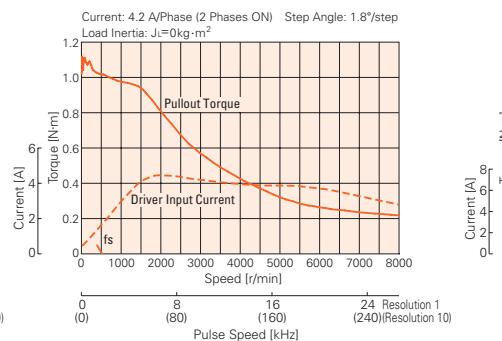

**RBK268A/RBK268B**

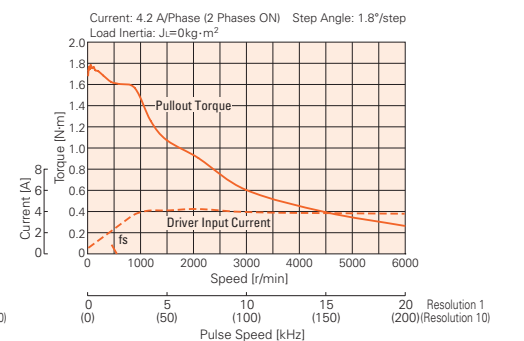

# Standard Type: Motor Frame Size 85 mm

Model	Single Shaft		RBK296A	RBK299A	RBK2913A
	Double Shaft		RBK296B	RBK299B	RBK2913B
Maximum Holding Torque	N·m		2.2	4.4	6.6
Rotor Inertia	J:kg·m <sup>2</sup>		1400 × 10 <sup>-7</sup>	2700 × 10 <sup>-7</sup>	4000 × 10 <sup>-7</sup>
Rated Current	A/Phase		4.5		
Basic Step Angle	1.8°				
Power Source	20~75 VDC 5.2A				
Excitation Mode	Microstep				
Mass	Motor	kg	1.7	2.8	3.8
	Driver	kg	0.35		

## Speed – Torque Characteristics

### 24 VDC Input

**RBK296A/RBK296B**

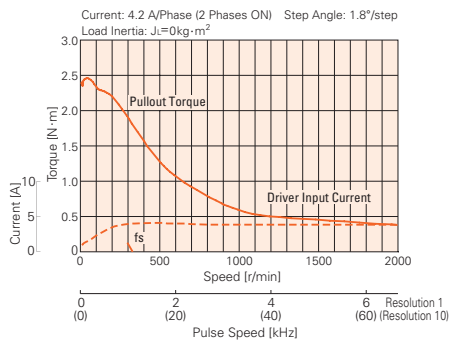

**RBK299A/RBK299B**

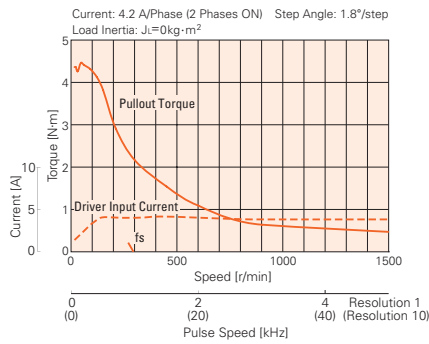

**RBK2913A/RBK2913B**

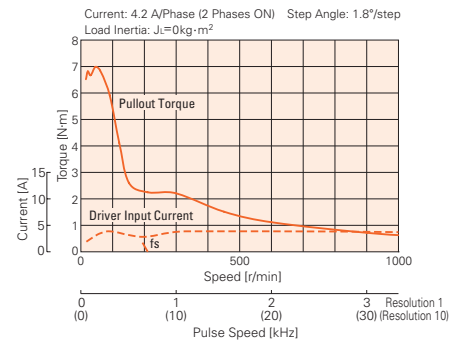

### 48 VDC Input

**RBK296A/RBK296B**

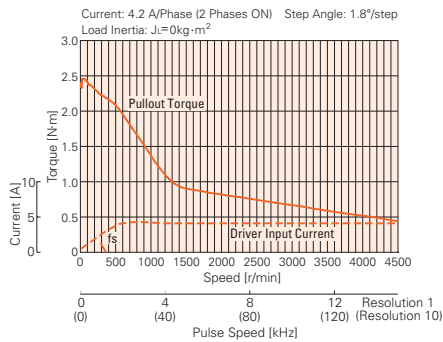

**RBK299A/RBK299B**

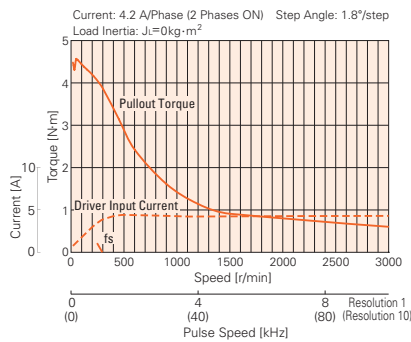

**RBK2913A/RBK2913B**

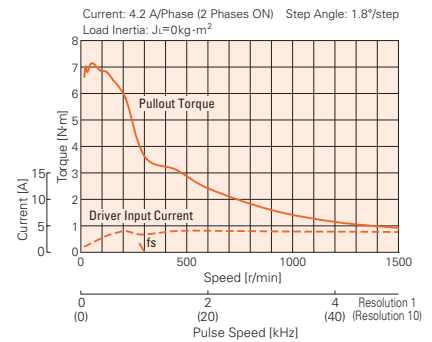

### 75 VDC Input

**RBK296A/RBK296B**

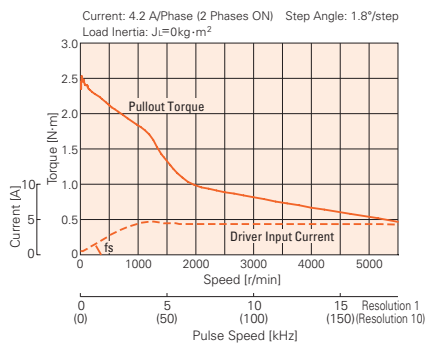

**RBK299A/RBK299B**

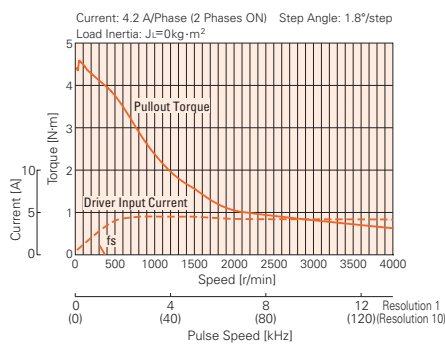

**RBK2913A/RBK2913B**

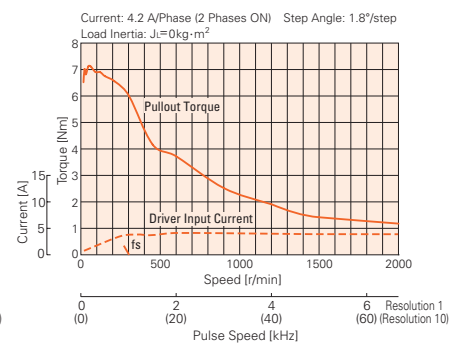

## ■ Dimensions (Unit = mm)

### ● High-Torque Type: Motor Frame Size 56.4 mm

Model	Motor Model	L1	L2
RBK264PA	PK264PDA	39	-
RBK264PB	PK264PDB		62
RBK266PA	PK266PDA	54	-
RBK266PB	PK266PDB		77
RBK268PA	PK268PDA	76	-
RBK268PB	PK268PDB		99

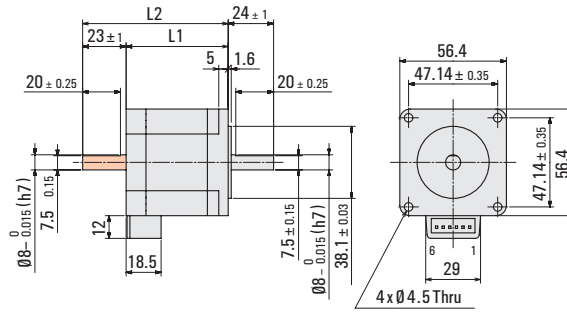

- These dimensions are for double shaft models. For single shaft models, ignore the orange (■) areas.

#### Motor Cable: LC2B06C

Motor Lead Wire/Connector assembly (0.6 m) is included with the motor and driver package. If you are purchasing only a motor, motor lead wire/connector assembly and connector will not be supplied. They must be purchased separately.

#### Applicable Connector

Connector Housing: 51067-0600 (MOLEX)

Contact: 50217-9101 (MOLEX)

Crimp Tool: 57189-5000 (MOLEX)

57190-5000 (MOLEX)

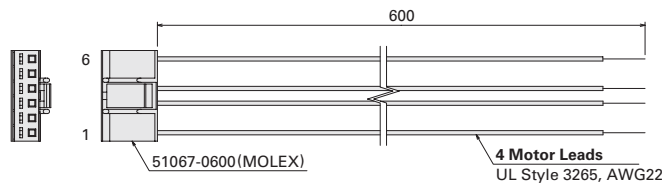

### ● Standard Type: Motor Frame Size 56.4 mm

Model	Motor Model	L1	L2
RBK264A	PK264DA	39	-
RBK264B	PK264DB		55
RBK266A	PK266DA	54	-
RBK266B	PK266DB		70
RBK268A	PK268DA	76	-
RBK268B	PK268DB		92

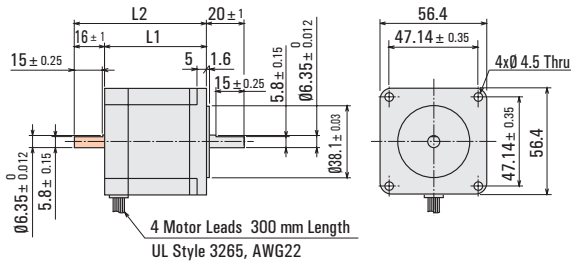

- These dimensions are for double shaft models. For single shaft models, ignore the orange (■) areas.

### ● Standard Type: Motor Frame Size 85 mm

Model	Motor Model	L1	L2
RBK296A	PK296DA	66	-
RBK296B	PK296DB		100
RBK299A	PK299DA	96	-
RBK299B	PK299DB		130
RBK2913A	PK2913DA	126	-
RBK2913B	PK2913DB		160

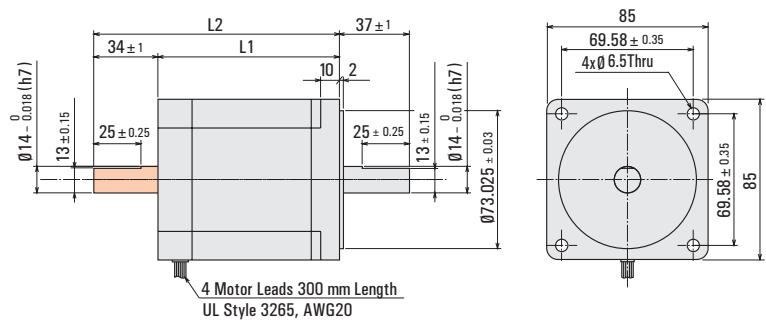

- These dimensions are for double shaft models. For single shaft models, ignore the orange (■) areas.

## ■ Accessories

### ● Flexible Couplings (Sold separately)

#### ● Features of MCS Couplings

This three-piece coupling adopts an aluminum alloy hub and a resin spider. The simple construction ensures that the high torque generated by a geared motor can be transmitted reliably. The proper elasticity of the spider suppresses motor vibration.

- A spider (material: polyurethane) controls the vibration generated by the motor
- No backlash



### ● Mounting Brackets (Sold separately)

Mounting brackets are convenient for installation and securing a stepping motor.



### ● DIN Rail Mounting Plate (Sold separately) (Available when the input voltage to the driver is 48 VDC or less)

This mounting plate is convenient for installing the driver of **RBK** Series on DIN rails with ease.

Model: **PADP01**



### ● Controller (Sold separately)

#### Controller for Stepping Motor

### **SG8030JY**

All operations including data setting can easily be performed using the four touch pads on the top panel. In addition, the number of signal lines is reduced to a minimum for easy connection.



DIN Rail Mounting Model



Recessed Mounting Model

This product is manufactured at a plant certified with the international standards **ISO 9001** (for quality assurance) and **ISO 14001** (for systems of environmental management).

Specifications are subject to change without notice.

This catalogue was published in October, 2009.

# Orientalmotor

#### **ORIENTAL MOTOR (EUROPA) GmbH**

[www.orientalmotor.de](http://www.orientalmotor.de)

##### European Headquarters and Düsseldorf Office

Schießstraße 74  
40549 Düsseldorf, Germany  
Tel: 0211-5206700 Fax: 0211-52067099

#### **ORIENTAL MOTOR (FRANCE) SARL**

[www.orientalmotor.fr](http://www.orientalmotor.fr)

##### France Headquarters

32, Avenue de l'île Saint Martin  
92737 Nanterre Cedex, France  
Tel: 01 47 86 97 50 Fax: 01 47 82 45 16

#### **ORIENTAL MOTOR (UK) LTD.**

[www.oriental-motor.co.uk](http://www.oriental-motor.co.uk)

Unit 5, Faraday Office Park,  
Rankine Road, Basingstoke,  
Hampshire RG24 8AH U.K.  
Tel: 01256-347090 Fax: 01256-347099

#### **ORIENTAL MOTOR CO., LTD.**

[www.orientalmotor.co.jp](http://www.orientalmotor.co.jp)

##### Headquarters

16-17, Ueno 6-chome  
Taito-ku, Tokyo 110-8536, Japan  
Tel: (03)3835-0684 Fax: (03)3835-1890

#### **ORIENTAL MOTOR ITALIA s.r.l.**

[www.orientalmotor.it](http://www.orientalmotor.it)

##### Italy Headquarters

Via A. De Gasperi, 85  
20017 Mazzo di Rho (MI), Italy  
Tel: 02-93906346 Fax: 02-93906348

For more information please contact: