

## Compact Motorized Cylinder DR Series $\alpha$ STEP AZ Series Equipped

The compact and lightweight linear actuators consist of a stepper motor and an integrated ball screw.  
The **AZ** Series drive motor is equipped with a battery-free absolute sensor, eliminating the need for external reference sensors or limit switches.

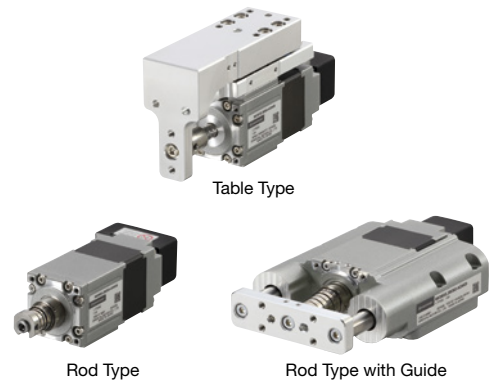

### Reduced Commissioning Time

#### ● Linear Mechanism in a Compact Housing

As no additional parts are required, the time needed for design, component selection, and assembly can be reduced.

This reduction in commissioning time frees-up resources, increasing efficiency and productivity.

#### ● Preset Parameters

Resolution: 0,001 mm

Stroke Units: mm

Speed Units: mm/s

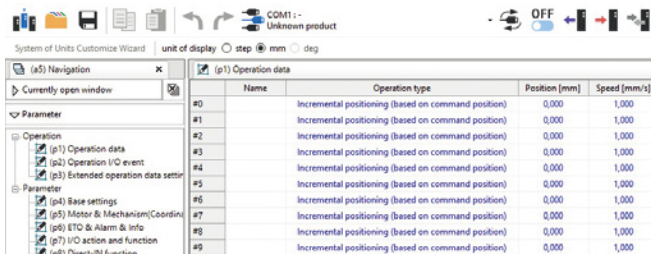

#### ● Comparison of the Number of Components

System configuration examples for moving a load with the same stroke length.

##### ◇ In-House Design

Number of components: 9

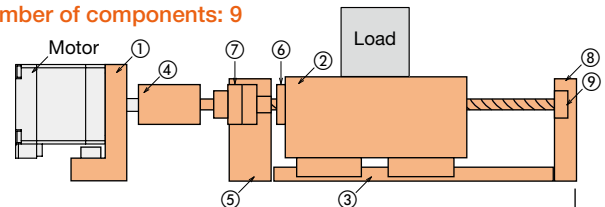

##### ◇ DR Series Table Type

Number of components: 1

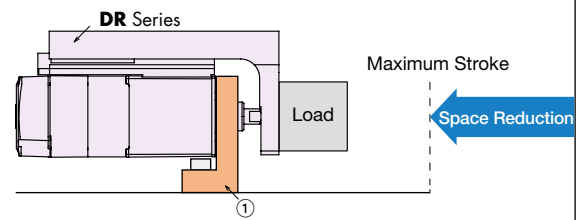

- [Parts Used]
- ① Installation plate, ② Transportation table,
  - ③ Linear guide, ④ Coupling, ⑤ Fixed-side block,
  - ⑥ Ball screw, ⑦ Fixed-side bearing,
  - ⑧ Support-side block, ⑨ Support-side bearing

### Space Saving and Less Wiring with the **ABZO** Sensor

In addition to the compact and lightweight body, **AZ** Series motors use a battery-free absolute encoder, the **ABZO** sensor. This means that neither reference sensors nor limit switches are required. The costs are lower, wiring is simpler, and no maintenance is required.

#### Application Example

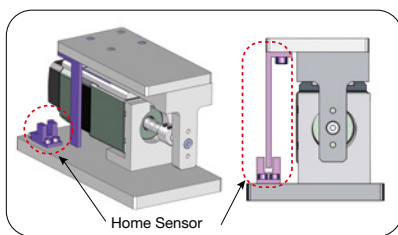

With home sensor

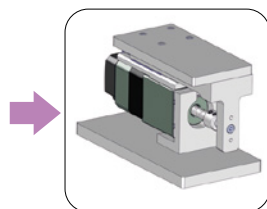

Without home sensor

The **DR** Series uses the same drivers and cables as the  $\alpha$ STEP **AZ** Series.

Details of the  $\alpha$ STEP **AZ** Series can be found in the separate **AZ** Series catalogue.



# Typical Applications

Automation of a micrometer stage

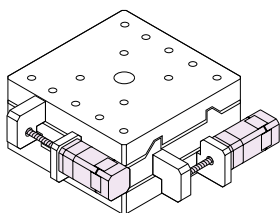

Alignment of a PCB

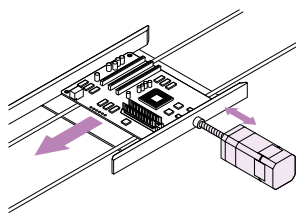

Vertical Positioning of Probes

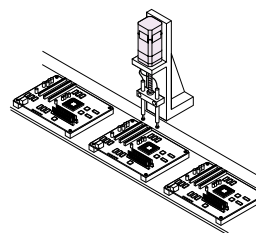

## Various mounting options are available

- Table Type

Mounting: front or side.

Products with a mounting plate (flange, foot\*) can also be installed on the rear face using the flange or on the top face using the base.

\*Materials: Aluminum Surface treatment: None











- Rod Type with Guide

Mounting: front, back and side.

When mounting from the side, the mounting screws can be tightened from above and below.

Configuration	Installation Methods			
Table Type Rod Type	<p>· Front mounting</p>	<p>· Side face mounting</p>	<p>· Flange Mounting (Table type only)</p>	<p>· Base Mounting</p>
Rod Type with Guide	<p>· Front mounting</p>	<p>· Rear face mounting</p>	<p>· Side face mounting A</p>	<p>· Side face mounting B</p>

# Product line

Compact Motorized Cylinder							Driver* (24 VDC)	Connection cable
Configuration	Frame Size	Stroke	Ball Screw Type		Cable Pull-Out Direction	Installation Plate		
			Version	Lead Screw Pitch				
<b>Table Type</b>  The load can be mounted directly on the linear table.	28 mm	30 mm	Precision / With precision cover	1 mm / 2,5 mm	Underside / Right / Left	- / With flange With foot	<ul style="list-style-type: none"> <li>● Built-in Controller Type </li> <li>● Pulse Input Type with RS-485 Communication </li> <li>● Pulse Input Type </li> <li>● With EtherCAT interface  <b>EtherCAT</b></li> <li>● With Ethernet/IP interface  <b>EtherNet/IP</b></li> <li>● With PROFINET interface  <b>PROFINET</b></li> </ul>	
<b>Rod Type with Guide</b>  The load can be mounted directly on the guide rods.					Top / Underside	-		
<b>Rod Type</b>  The load must be mounted on an external linear table or on a guide.					Top / Underside Right / Left	- / With foot		

\*Multi-axis drivers for 2 - 4 axes are available. For details, please refer to the separate **QSTEP AZ** Series catalogue.

## ● With Ball Screw Cover

Versions with a ball screw cover are available for increased dust protection.

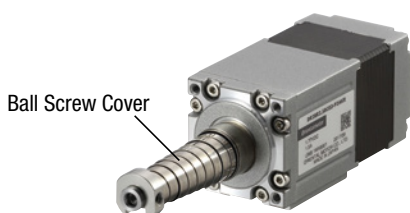

- **EtherNet/IP™** is a trademark of ODVA (Open DeviceNet Vendor Association)
- **EtherCAT** is a registered trademark and patented technology, licensed by Beckhoff Automation GmbH, Germany
- **PROFINET** is a registered trademark of PROFIBUS Nutzerorganisation e.V. (PNO)

## Product Number

### Compact Electric Cylinder

# DR 28 T 2.5 BC 03 - AZ A K R - P

①	②	③	④	⑤	⑥	⑦	⑧	⑨	⑩	⑪
①	Series Name	<b>DR: DR Series</b>								
②	Frame Size	<b>28: 28 mm</b>								
③	Type	<b>T: Table Type</b> <b>G: Rod Type with Guide</b> <b>R: Rod Type</b>								
④	Ball Screw Lead	<b>1: 1 mm</b> <b>2.5: 2.5 mm</b>								
⑤	Ball Screw Type	<b>B: Precision Ball Screw</b> <b>BC: Precision Ball Screw with Cover</b>								
⑥	Stroke	<b>03: 30 mm</b>								
⑦	Equipped Motor	<b>AZ: AZ Series</b>								
⑧	Additional Function	<b>A: without Additional Function</b>								
⑨	Power Supply Input	<b>K: DC Power Supply Input</b>								
⑩	Cable Outlet Direction*	<b>U: Upper Side</b> <b>D: Downward Side</b> <b>R: Right Side</b> <b>L: Left Side</b>								
⑪	Mounting Plate	Blank: without Mounting Plate <b>F: with Flange</b> <b>P: with Foot</b>								

\* The cable outlet direction can be seen in the following illustrations.

Products viewed from the rear, mounting surfaces downward.

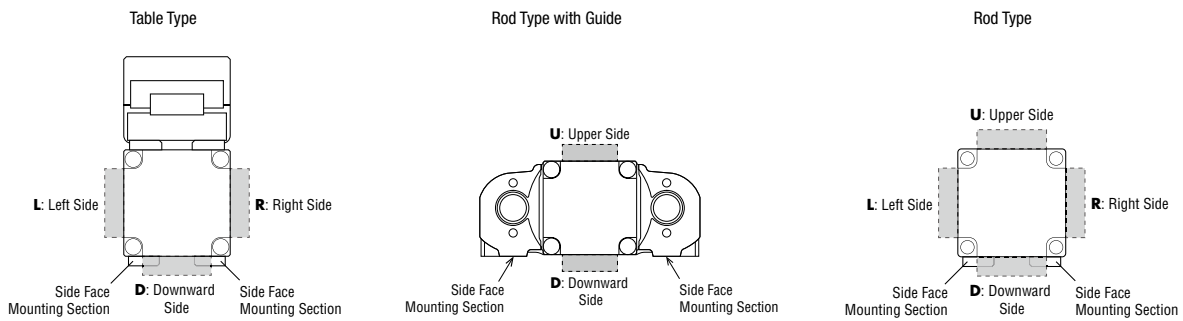

### Driver

# AZD - K D

①	②	③
①	Driver Type	<b>AZD: AZ Series Driver</b>
②	Power Supply Input	<b>K: 24 VDC</b>
③	Type	Blank: Pulse Input <b>D: Built-in Controller Type</b> <b>X: Pulse Input Type with RS-485 Communication</b> <b>ED: With EtherCAT interface</b> <b>EP: With Ethernet/IP interface</b> <b>PN: With PROFINET interface</b>

### Connection Cable/Flexible Connection Cable

# CC 050 V Z 2 F 2

①	②	③	④	⑤	⑥	⑦							
①		<b>CC: Cable</b>											
②	Length	<b>005: 0.5 m</b>	<b>010: 1 m</b>	<b>015: 1.5 m</b>	<b>020: 2 m</b>	<b>025: 2.5 m</b>	<b>030: 3 m</b>	<b>040: 4 m</b>	<b>050: 5 m</b>	<b>070: 7 m</b>	<b>100: 10 m</b>	<b>150: 15 m</b>	<b>200: 20 m</b>
	Reference Number												
④	Applicable Model	<b>Z: AZ Series</b>											
⑤	Reference Number	<b>2: Frame Size 20 mm, 28 mm</b>											
⑥	Cable Type	<b>F: Connection Cable</b> <b>R: Flexible Connection Cable</b>											
⑦	Power Supply Cable	<b>2: DC Power Supply Input</b>											

## Product Line

### Compact Electric Cylinders

#### Table Type



##### • Precision Ball Screw

Ball Screw Lead [mm]	Mounting Plate	Product Name	List Price
1	-	<b>DR28T1B03-AZAKD</b> <b>DR28T1B03-AZAKR</b> <b>DR28T1B03-AZAKL</b>	1.072,00 €
	with Flange	<b>DR28T1B03-AZAKD-F</b> <b>DR28T1B03-AZAKR-F</b> <b>DR28T1B03-AZAKL-F</b>	1.107,00 €
	with Foot	<b>DR28T1B03-AZAKD-P</b> <b>DR28T1B03-AZAKR-P</b> <b>DR28T1B03-AZAKL-P</b>	
2.5	-	<b>DR28T2.5B03-AZAKD</b> <b>DR28T2.5B03-AZAKR</b> <b>DR28T2.5B03-AZAKL</b>	1.072,00 €
	with Flange	<b>DR28T2.5B03-AZAKD-F</b> <b>DR28T2.5B03-AZAKR-F</b> <b>DR28T2.5B03-AZAKL-F</b>	1.107,00 €
	with Foot	<b>DR28T2.5B03-AZAKD-P</b> <b>DR28T2.5B03-AZAKR-P</b> <b>DR28T2.5B03-AZAKL-P</b>	



##### • Precision Ball Screw with Cover

Ball Screw Lead [mm]	Mounting Plate	Product Name	List Price
1	-	<b>DR28T1BC03-AZAKD</b> <b>DR28T1BC03-AZAKR</b> <b>DR28T1BC03-AZAKL</b>	1.090,00 €
	with Flange	<b>DR28T1BC03-AZAKD-F</b> <b>DR28T1BC03-AZAKR-F</b> <b>DR28T1BC03-AZAKL-F</b>	1.125,00 €
	with Foot	<b>DR28T1BC03-AZAKD-P</b> <b>DR28T1BC03-AZAKR-P</b> <b>DR28T1BC03-AZAKL-P</b>	
2.5	-	<b>DR28T2.5BC03-AZAKD</b> <b>DR28T2.5BC03-AZAKR</b> <b>DR28T2.5BC03-AZAKL</b>	1.090,00 €
	with Flange	<b>DR28T2.5BC03-AZAKD-F</b> <b>DR28T2.5BC03-AZAKR-F</b> <b>DR28T2.5BC03-AZAKL-F</b>	1.125,00 €
	with Foot	<b>DR28T2.5BC03-AZAKD-P</b> <b>DR28T2.5BC03-AZAKR-P</b> <b>DR28T2.5BC03-AZAKL-P</b>	

#### Rod Type with Guide



##### • Precision Ball Screw

Ball Screw Lead [mm]	Product Name	List Price
1	<b>DR28G1B03-AZAKU</b> <b>DR28G1B03-AZAKD</b>	956,00 €
2.5	<b>DR28G2.5B03-AZAKU</b> <b>DR28G2.5B03-AZAKD</b>	



##### • Precision Ball Screw with Cover

Ball Screw Lead [mm]	Product Name	List Price
1	<b>DR28G1BC03-AZAKU</b> <b>DR28G1BC03-AZAKD</b>	974,00 €
2.5	<b>DR28G2.5BC03-AZAKU</b> <b>DR28G2.5BC03-AZAKD</b>	

#### Rod Type



##### • Precision Ball Screw

Ball Screw Lead [mm]	Mounting Plate	Product Name	List Price
1	-	<b>DR28R1B03-AZAKU</b> <b>DR28R1B03-AZAKD</b> <b>DR28R1B03-AZAKR</b> <b>DR28R1B03-AZAKL</b>	885,00 €
	with Foot	<b>DR28R1B03-AZAKU-P</b> <b>DR28R1B03-AZAKD-P</b> <b>DR28R1B03-AZAKR-P</b> <b>DR28R1B03-AZAKL-P</b>	920,00 €
2.5	-	<b>DR28R2.5B03-AZAKU</b> <b>DR28R2.5B03-AZAKD</b> <b>DR28R2.5B03-AZAKR</b> <b>DR28R2.5B03-AZAKL</b>	885,00 €
	with Foot	<b>DR28R2.5B03-AZAKU-P</b> <b>DR28R2.5B03-AZAKD-P</b> <b>DR28R2.5B03-AZAKR-P</b> <b>DR28R2.5B03-AZAKL-P</b>	920,00 €



##### • Precision Ball Screw with Cover

Ball Screw Lead [mm]	Mounting Plate	Product Name	List Price
1	-	<b>DR28R1BC03-AZAKU</b> <b>DR28R1BC03-AZAKD</b> <b>DR28R1BC03-AZAKR</b> <b>DR28R1BC03-AZAKL</b>	902,00 €
	with Foot	<b>DR28R1BC03-AZAKU-P</b> <b>DR28R1BC03-AZAKD-P</b> <b>DR28R1BC03-AZAKR-P</b> <b>DR28R1BC03-AZAKL-P</b>	938,00 €
2.5	-	<b>DR28R2.5BC03-AZAKU</b> <b>DR28R2.5BC03-AZAKD</b> <b>DR28R2.5BC03-AZAKR</b> <b>DR28R2.5BC03-AZAKL</b>	902,00 €
	with Foot	<b>DR28R2.5BC03-AZAKU-P</b> <b>DR28R2.5BC03-AZAKD-P</b> <b>DR28R2.5BC03-AZAKR-P</b> <b>DR28R2.5BC03-AZAKL-P</b>	938,00 €

● Driver

◇ Built-in Controller Type



◇ Pulse Input Type with RS-485 Communication



◇ Pulse Input Type



Product Name	List Price
<b>AZD-KD</b>	360,00 €

Product Name	List Price
<b>AZD-KX</b>	360,00 €

Product Name	List Price
<b>AZD-K</b>	310,00 €

◇ With EtherCAT interface



◇ With Ethernet/IP interface



◇ With PROFINET interface



Product Name	List Price
<b>AZD-KED</b>	400,00 €

Product Name	List Price
<b>AZD-KEP</b>	400,00 €

Product Name	List Price
<b>AZD-KPN</b>	400,00 €

■ Connection Cables/Flexible Connection Cables

Use a flexible connection cable for applications in which the cables are in motion.



◇ Cable for Motor/Cable for Encoder

Product Line	Length [m]	Product Name	List Price
Connection Cable	0.5	<b>CC005VZ2F2</b>	29,00 €
	1	<b>CC010VZ2F2</b>	29,00 €
	1.5	<b>CC015VZ2F2</b>	33,00 €
	2	<b>CC020VZ2F2</b>	38,00 €
	2.5	<b>CC025VZ2F2</b>	43,00 €
	3	<b>CC030VZ2F2</b>	48,00 €
	4	<b>CC040VZ2F2</b>	75,00 €
	5	<b>CC050VZ2F2</b>	84,00 €
	7	<b>CC070VZ2F2</b>	104,00 €
	10	<b>CC100VZ2F2</b>	135,00 €
	15	<b>CC150VZ2F2</b>	187,00 €
20	<b>CC200VZ2F2</b>	237,00 €	

Product Line	Length [m]	Product Name	List Price
Flexible Connection Cable	0.5	<b>CC005VZ2R2</b>	65,00 €
	1	<b>CC010VZ2R2</b>	65,00 €
	1.5	<b>CC015VZ2R2</b>	70,00 €
	2	<b>CC020VZ2R2</b>	76,00 €
	2.5	<b>CC025VZ2R2</b>	81,00 €
	3	<b>CC030VZ2R2</b>	85,00 €
	4	<b>CC040VZ2R2</b>	97,00 €
	5	<b>CC050VZ2R2</b>	108,00 €
	7	<b>CC070VZ2R2</b>	138,00 €
	10	<b>CC100VZ2R2</b>	181,00 €
	15	<b>CC150VZ2R2</b>	245,00 €
20	<b>CC200VZ2R2</b>	326,00 €	

■ Included

● Compact Electric Cylinders

Included	Operating Manual
Type	
Common to All Types	1 Copy

● Drivers

Included	Connector	Operating Manual
Type		
Common to All Types	CN4 Connector (1 pc.) CN1 Connector (1 pc.)	1 Copy

● Connection Cables/Flexible

Included	Operating Manual
Type	
Connection Cable	-
Flexible Connection Cable	1 Copy

# How to Read Specifications Table

## Compact Electric Cylinder Specifications

Actuator Product Name	Ball Screw	DR28T2.5B03-AZAK□-□	
	Ball Screw with Cover	DR28T2.5BC03-AZAK□-□	
① Ball Screw Pitch	mm	2,5	
Ball Screw Type		Precision	
Repetitive Positioning Accuracy	① Table Tip	mm	±0,003
	② Upper Side	mm	±0,005
③ Lost Motion	mm	0,02 max.	
④ Minimum Travel Amount	mm	0,001	
⑤ Permissible Moment	Statisch	Nm	Mp: 0,30 My: 0,24 Mr: 1,5
	Dynamisch	Nm	Mp: 0,30 My: 0,24 Mr: 1,5
⑥ Transportable Mass	Horizontal	kg	4
	Vertikal	kg	2
⑦ Thrust	N	20	
⑧ Push Force	N	50	
⑨ Holding Force	N	20	
⑩ Stroke	mm	30	
⑪ Maximum Speed	mm/s	100	
⑫ Maximum Acceleration	m/s <sup>2</sup>	0,5	

### ① Ball Screw Pitch

Linear distance travelled by the ball screw per motor revolution.

### ② Repetitive Positioning Accuracy

This value indicates the degree of deviation that is generated when repeatedly approaching a position from the same direction. (The specification applies to a constant temperature and constant load.)

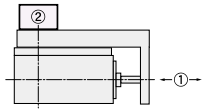

- ① Repeat positioning accuracy of the table end.
- ② Repeat positioning accuracy on the table top. If there is no distinction between ① and ②, values for the repetitive positioning accuracy are the same.

### ③ Lost Motion

This value indicates the degree of deviation that is generated when repeatedly approaching the same position from different directions. (The specification applies to a constant temperature and constant load.)

### ④ Minimum Travel Amount

Factory setting for the travel distance per pulse.

### ⑤ Permissible Moment

The maximum force that can be applied to the guide if the centre of gravity of the actuator and the load do not match.

The dynamic permissible moment refers to the moment while in motion.

The static moment refers to the moment while at a standstill.

## • Table Type

Horizontal Direction

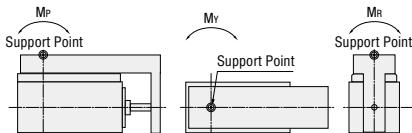

Vertical Direction

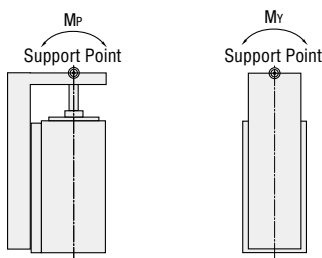

## • Rod Type

Horizontal Direction

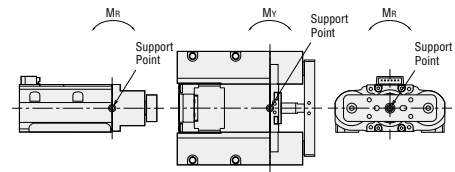

Vertical Direction

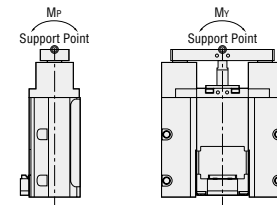

### ⑥ Transportable Mass

#### • Horizontal Direction (Figure A)

Maximum transport load when used in a horizontal direction.

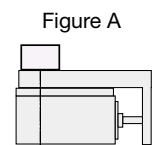
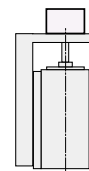

Figure A

#### • Vertical Direction (Figure B)

Maximum transport load when used in a vertical direction.

Figure B



### ⑦ Thrust

Maximum force with which a load can be pushed at maximum speed.

### ⑧ Push Force

Maximum force that can be applied when pressing or clamping.

### ⑨ Holding Force

Maximum holding force of the motor at standstill with reduced standstill current in effect (50% rated current).

### ⑩ Stroke

Maximum travel distance.

### ⑪ Maximum Speed

Maximum adjustable speed.

### ⑫ Maximum Acceleration

Maximum adjustable acceleration.

# Compact Electric Cylinder Specifications



## Table Type

Actuator Product Name	Ball Screw	<b>DR28T1B03-AZAK</b> □-□	<b>DR28T2.5B03-AZAK</b> □-□
	Ball Screw with Cover	<b>DR28T1BC03-AZAK</b> □-□	<b>DR28T2.5BC03-AZAK</b> □-□
Ball Screw Lead	mm	1	2.5
Ball Screw Type		Precision	
Repetitive Positioning Accuracy	① Table Tip Position on Ball Screw Shaft	mm	±0.003
	② Upper Side of Linear Guide	mm	±0.005
Lost Motion	mm	0.02 max.	
Minimum Travel Amount	mm	0.001	
Permissible Moment	Static Permissible Moment	Nm	Mp: 0.30 MY: 0.24 Mr: 1.5
	Dynamic Permissible Moment	Nm	
Transportable Mass	Horizontal Direction	kg	4
	Vertical Direction	kg	4
Thrust	N	40	20
Push Force	N	-	50
Holding Force	N	40	20
Stroke	mm	30	
Maximum Speed	mm/s	40	100
Maximum Acceleration	m/s <sup>2</sup>	0.2	0.5

- Either **D** (downward side), **R** (right side), or **L** (left side) indicating the cable outlet direction is entered where the box □ is located within the product name.  
Either **F** (with flange) or **P** (with foot) indicating the mounting plate is entered where the box □ is located within the product name.

### Note

- The maximum speed may be lower depending on the ambient temperature and the length of the motor cable.
- Repetitive Positioning Accuracy

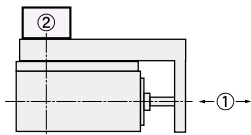

- ① Repeat positioning accuracy at the tip.
- ② Repeat positioning accuracy on the top.



## Rod Type with Guide



Actuator Product Name	Ball Screw		DR28G1B03-AZAK□	DR28G2.5B03-AZAK□
	Ball Screw with Cover		DR28G1BC03-AZAK□	DR28G2.5BC03-AZAK□
Ball Screw Lead		mm	1	2.5
Ball Screw Type			Precision	
Repetitive Positioning Accuracy		mm	±0.005	
Lost Motion		mm	0.05 max.	
Minimum Travel Amount		mm	0.001	
Permissible Moment	Static Permissible Moment	Nm	MP: 0.15 MY: 0.15 MR: 0.1	
	Dynamic Permissible Moment	Nm		
Transportable Mass	Horizontal Direction	kg	0.2 (4)*	
	Vertical Direction	kg	4	2
Thrust		N	40	20
Push Force		N	-	50
Holding Force		N	40	20
Stroke		mm	30	
Maximum Speed		mm/s	40	100
Maximum Acceleration		m/s <sup>2</sup>	0.2	0.5

● Either **U** (upper side) or **D** (downward side) indicating the cable outlet direction is entered where the box □ is located within the product name.

\* When using an external linear guide, refer to the specifications indicated in brackets.

### Note

● The maximum speed may be lower depending on the ambient temperature and the length of the motor cable.

## Rod Type



Actuator Product Name	Ball Screw		DR28R1B03-AZAK□-□	DR28R2.5B03-AZAK□-□
	Ball Screw with Cover		DR28R1BC03-AZAK□-□	DR28R2.5BC03-AZAK□-□
Ball Screw Lead		mm	1	2.5
Ball Screw Type			Precision	
Repetitive Positioning Accuracy		mm	±0.003	
Lost Motion		mm	0.02 max.	
Minimum Travel Amount		mm	0.001	
Transportable Mass	Horizontal Direction	kg	4*	
	Vertical Direction	kg	4	2
Thrust		N	40	20
Push Force		N	-	50
Holding Force		N	40	20
Stroke		mm	30	
Maximum Speed		mm/s	40	100
Maximum Acceleration		m/s <sup>2</sup>	0.2	0.5

● Either **U** (upper side), **D** (downward side), **R** (right side), or **L** (left side) indicating the cable outlet direction is entered where the box □ is located within the product name.

**P** (with foot) indicating the mounting plate is entered where the box □ is located within the product name.

If the product is not supplied with a mounting plate, there will be no □ within the product name.

\* The specified horizontal transport load is applicable when using an external linear guide.

### Note

● The maximum speed may be lower depending on the ambient temperature and the length of the motor cable.

## Positioning Distance—Positioning Time

### All Types

#### Horizontal Installation

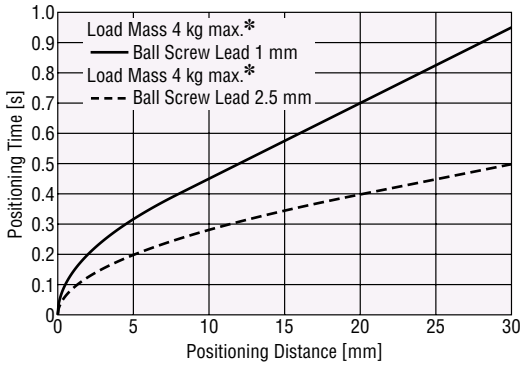

#### Vertical Installation

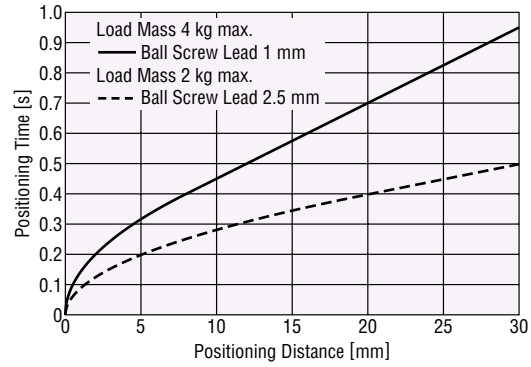

\*If the rod type with guide is not used in combination with an external linear guide, the transportable mass is 0.2 kg.

## Operating Speed—Load Mass

### Table Type, Rod Type\*

#### Horizontal Installation

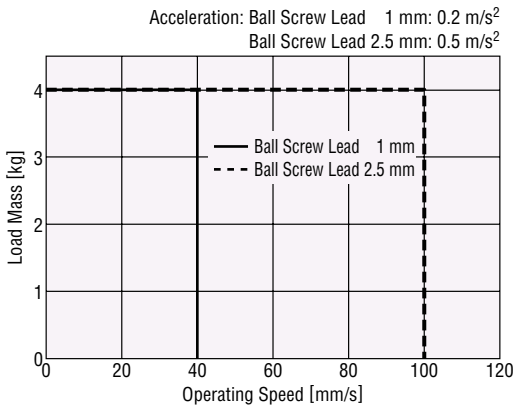

#### Vertical Installation

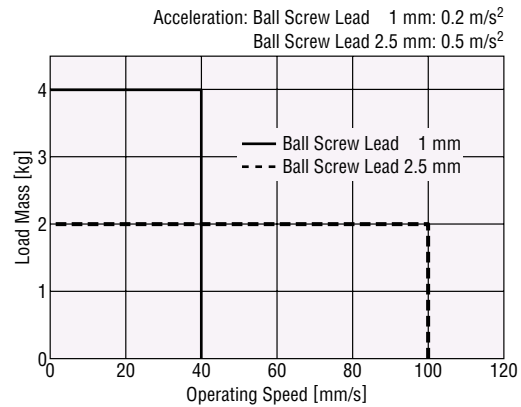

\*The standard version must not be used in a horizontal orientation without an external linear guide.

### Rod Type with Guide

#### Horizontal Installation\*

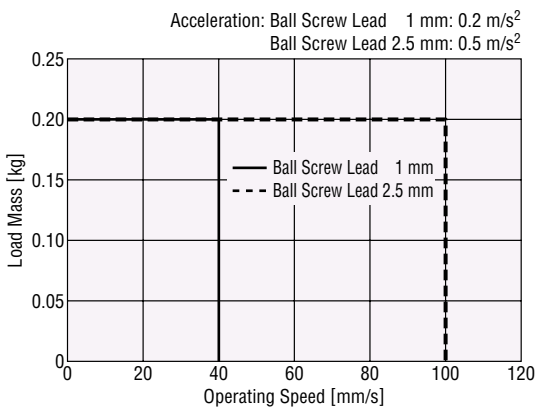

#### Vertical Installation

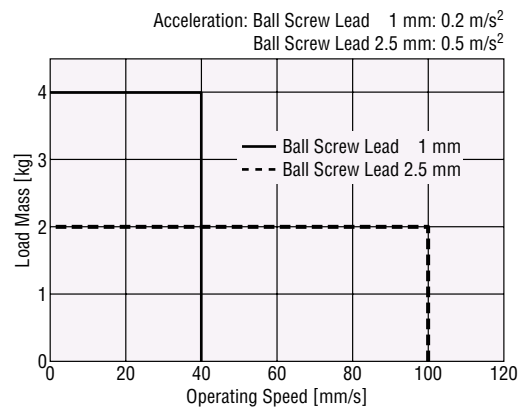

\*The characteristics when used in combination with an external linear guide will be the same as the table type.

## Positional Displacement Due to Temperature Rise (Reference Value)

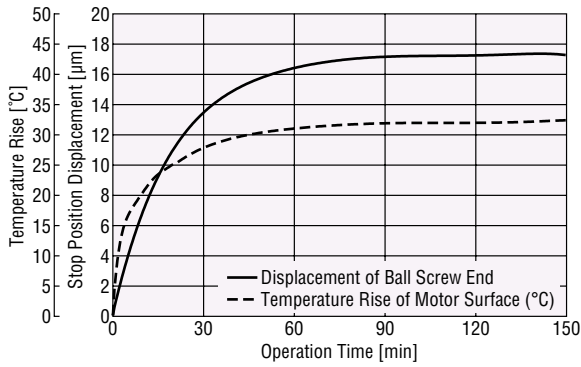

Conditions:  
 Operating Duty: 90%  
 Operating Current Ratio: 100% (Factory Setting)  
 Stop Current Ratio: 50% (Factory Setting)  
 Measurement Position: 30 mm from home position  
 Measuring Method: Measured by laser displacement meter

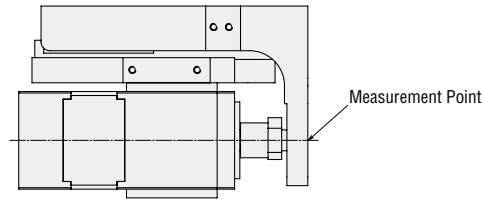

## Maximum Speed with Temperature Variance (Reference Value)

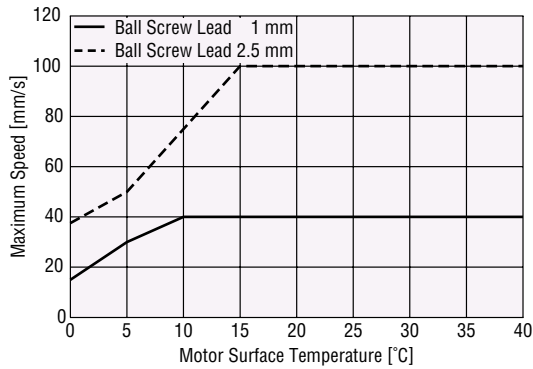

## Actual Push Force

The following table shows reference data for the push current and compressive force of the **DR28**. It is recommended to check the actual compressive force when using the product.

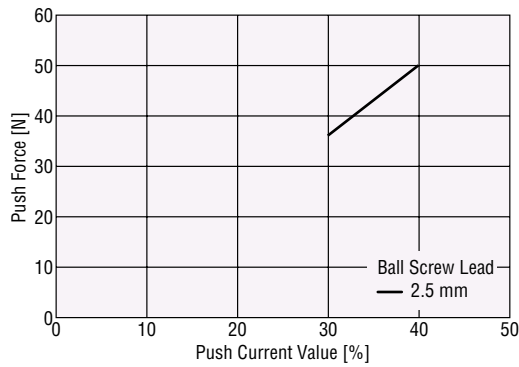

- The above characteristic diagram shows the results of the pressure measurement of the **DR28** in horizontal operation.
- The relationship between the push current value and the push force varies depending on the following conditions:
  - Installation Condition (Horizontal Installation or Vertical Installation)
  - Load Condition of the Equipment
  - Cable Length
  - Ambient Temperature
- The upper speed limit of the push-motion operation is 6 mm/s.

### Note

- Push-motion operation is not permitted for the **DR28** with 1 mm pitch.

## Driver Specifications

Product Name	<b>AZD-KD, AZD-KX, AZD-K, AZD-KED, AZD-KEP, AZD-KPN</b>	
Power Supply Input	Voltage	24 VDC $\pm$ 5%
	Input Current	A 1.4

## General Specifications

	Compact Electric Cylinder	Driver
Thermal Class	130 (B)	-
Insulation Resistance	100 M $\Omega$ or more when a 500 VDC megger is applied between the following places: · Case - Motor Windings	100 M $\Omega$ or more when a 500 VDC megger is applied between the following places: · Protective Earth Terminal - Power Supply Terminal
Dielectric Strength	Sufficient to withstand the following for 1 minute: · Case - Motor Windings 0.5 kVAC, 50 Hz or 60 Hz	-
Operating Environment (In Operation)	Ambient Temperature 0 to +40°C (Non-freezing)	0 to +50°C (Non-freezing)
	Ambient Humidity 85% or less (Non-condensing)	
	Atmosphere No corrosive gases or dust. The product should not be exposed to water, oil or other liquids.	
Degree of Protection	-	IP10

### Note

- Disconnect the motor and driver when taking an insulation resistance measurement or performing a dielectric voltage withstand test. Do not perform these tests on the absolute sensor part of the motor.

## Movement Direction

The factory default movement direction is as shown.

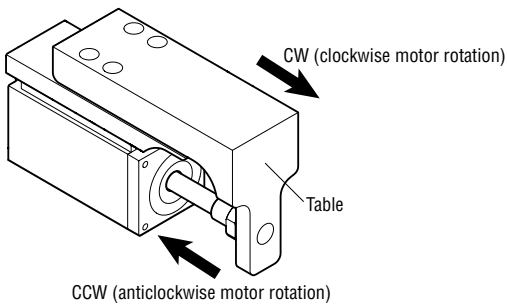

## Installing the Rod Type

### Center alignment

In the standard version, the axis of the ball screw must be in alignment with the movement direction of the load.

- For details on the centre alignment flange, see page 19.

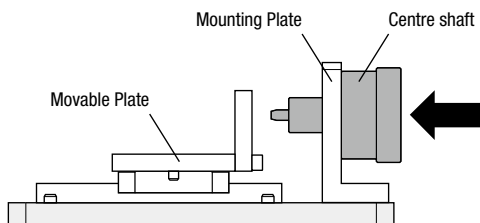

### Mounting

When installing the rod type, the spindle must be fixed in place for correct operation. A linear guide consisting of a guide rail, slide and table is required.

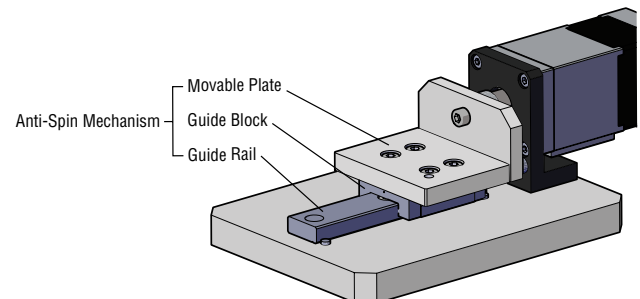

## Dimensions (All dimensions in mm)

### Table Type

Mounting Plate	Product Name	Mass [kg]
without Mounting Plate	<b>DR28T1B03-AZAK</b> □	0.39
	<b>DR28T1BC03-AZAK</b> □	
	<b>DR28T2.5B03-AZAK</b> □	
	<b>DR28T2.5BC03-AZAK</b> □	
with Flange	<b>DR28T1B03-AZAK</b> □-F	0.42
	<b>DR28T1BC03-AZAK</b> □-F	
	<b>DR28T2.5B03-AZAK</b> □-F	
	<b>DR28T2.5BC03-AZAK</b> □-F	
with Foot	<b>DR28T1B03-AZAK</b> □-P	0.42
	<b>DR28T1BC03-AZAK</b> □-P	
	<b>DR28T2.5B03-AZAK</b> □-P	
	<b>DR28T2.5BC03-AZAK</b> □-P	

● Either **D** (downward side), **R** (right side), or **L** (left side) indicating the cable outlet direction is entered where the box □ is located within the product name.

### ◇ Without Mounting Plate

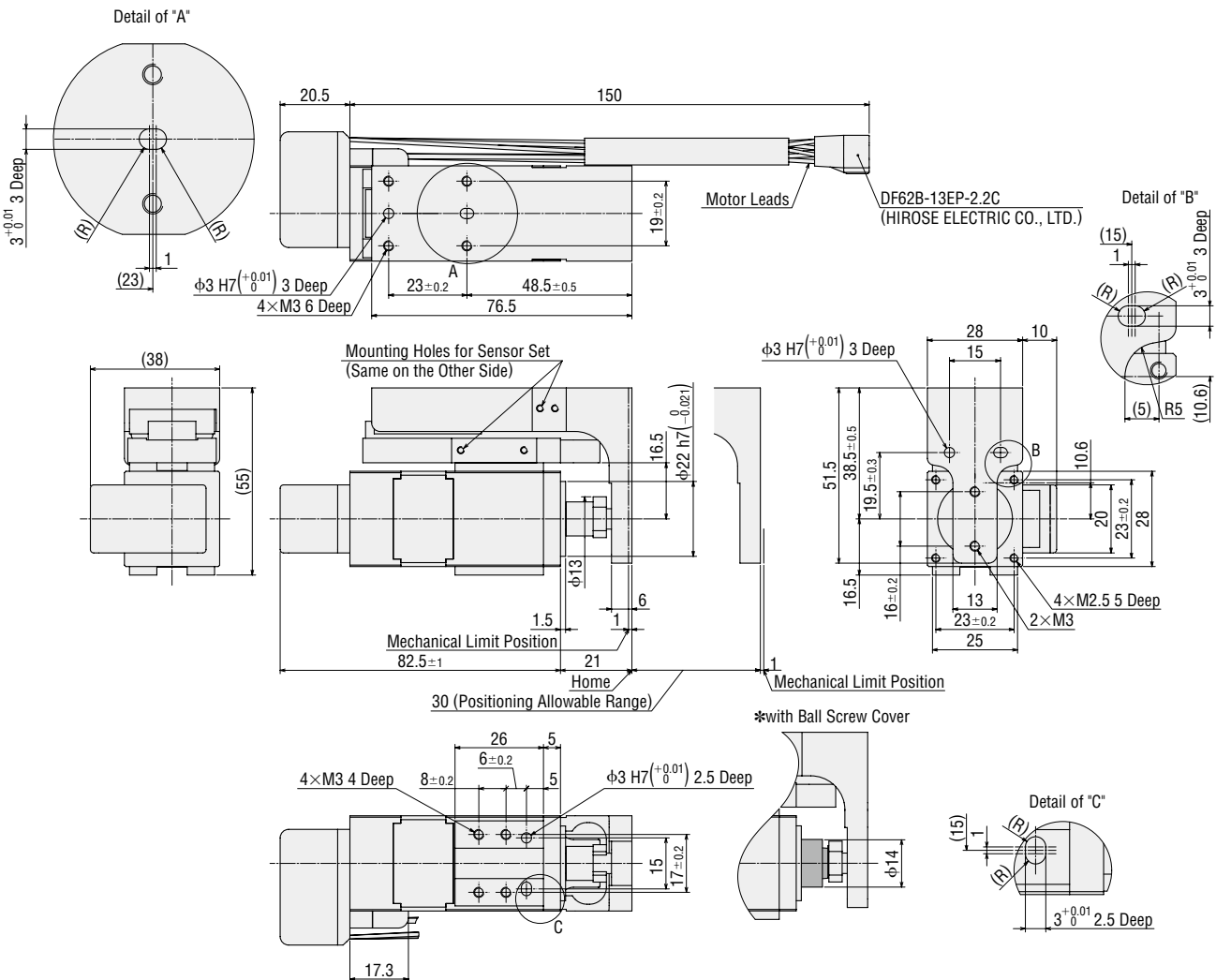

#### Note

- The reference point can be freely selected within the stroke. It must be ensured that a minimum distance of 1 mm to the mechanical end positions is maintained.
- The color part  represents the ball screw cover.

● **Mounting Plate Reference Dimensions (All dimensions in mm)**

When front mounting, a recess must be provided in the mounting plate to accommodate the stopper (ball screw cover).

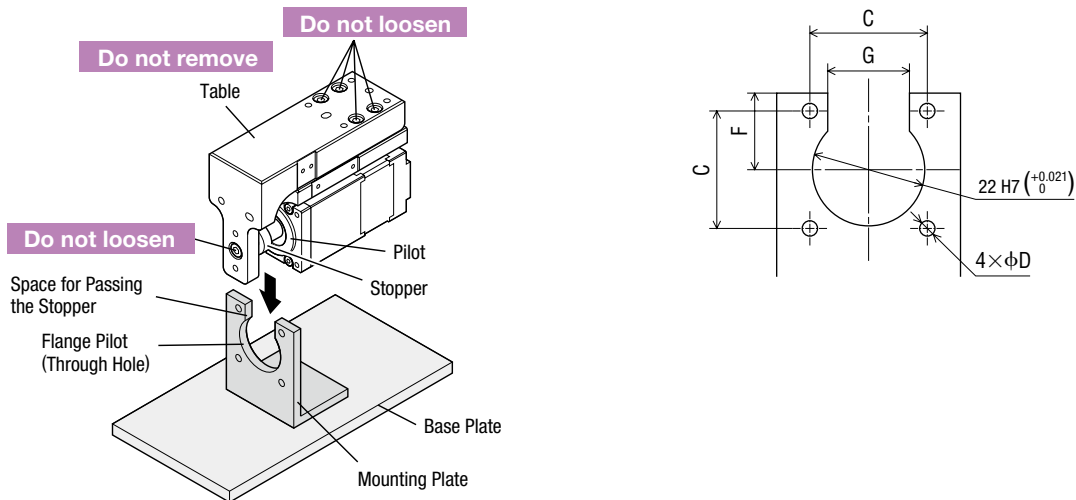

● Refer to the operating manual for installation.

◇ **Table Type with Flange**

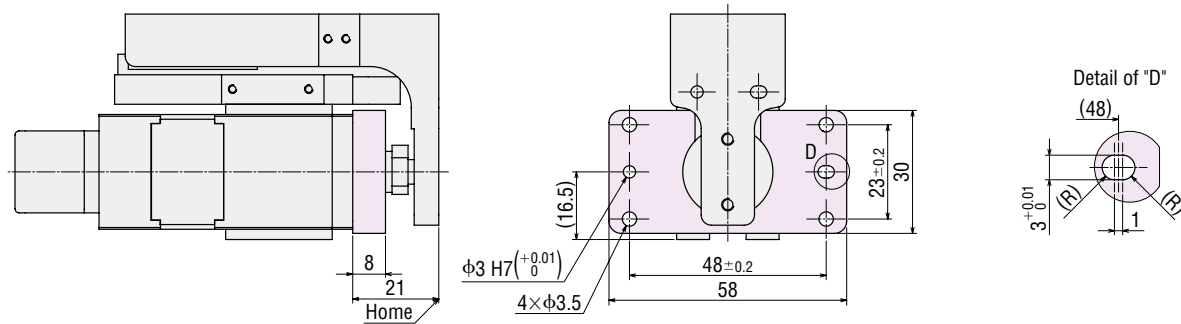

◇ **Table Type with Foot**

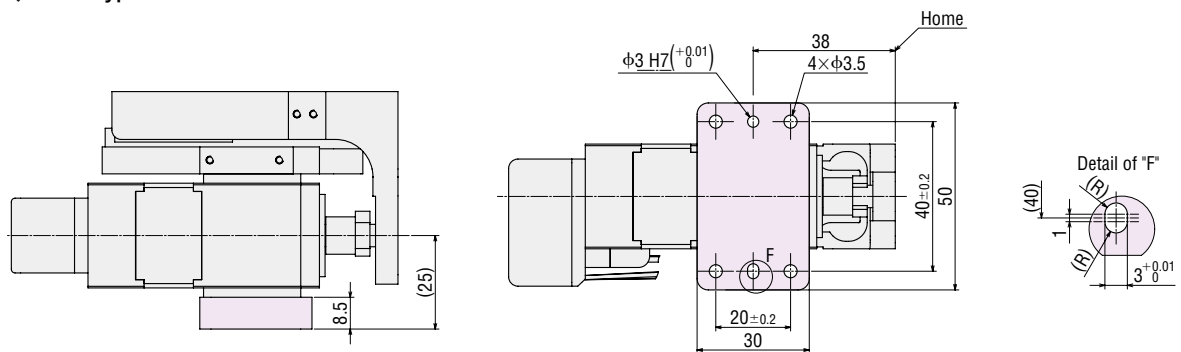

**Cable Outlet Direction**

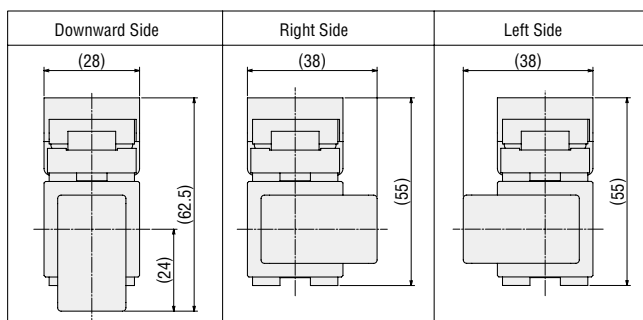

● The color part represents the mounting plate.

## Rod Type with Guide

Product Name	Mass [kg]
<b>DR28G1B03-AZAK</b> □	0.43
<b>DR28G1BC03-AZAK</b> □	
<b>DR28G2.5B03-AZAK</b> □	
<b>DR28G2.5BC03-AZAK</b> □	

● Either **U** (upper side) or **D** (downward side) indicating the cable outlet direction is entered where the box □ is located within the product name.

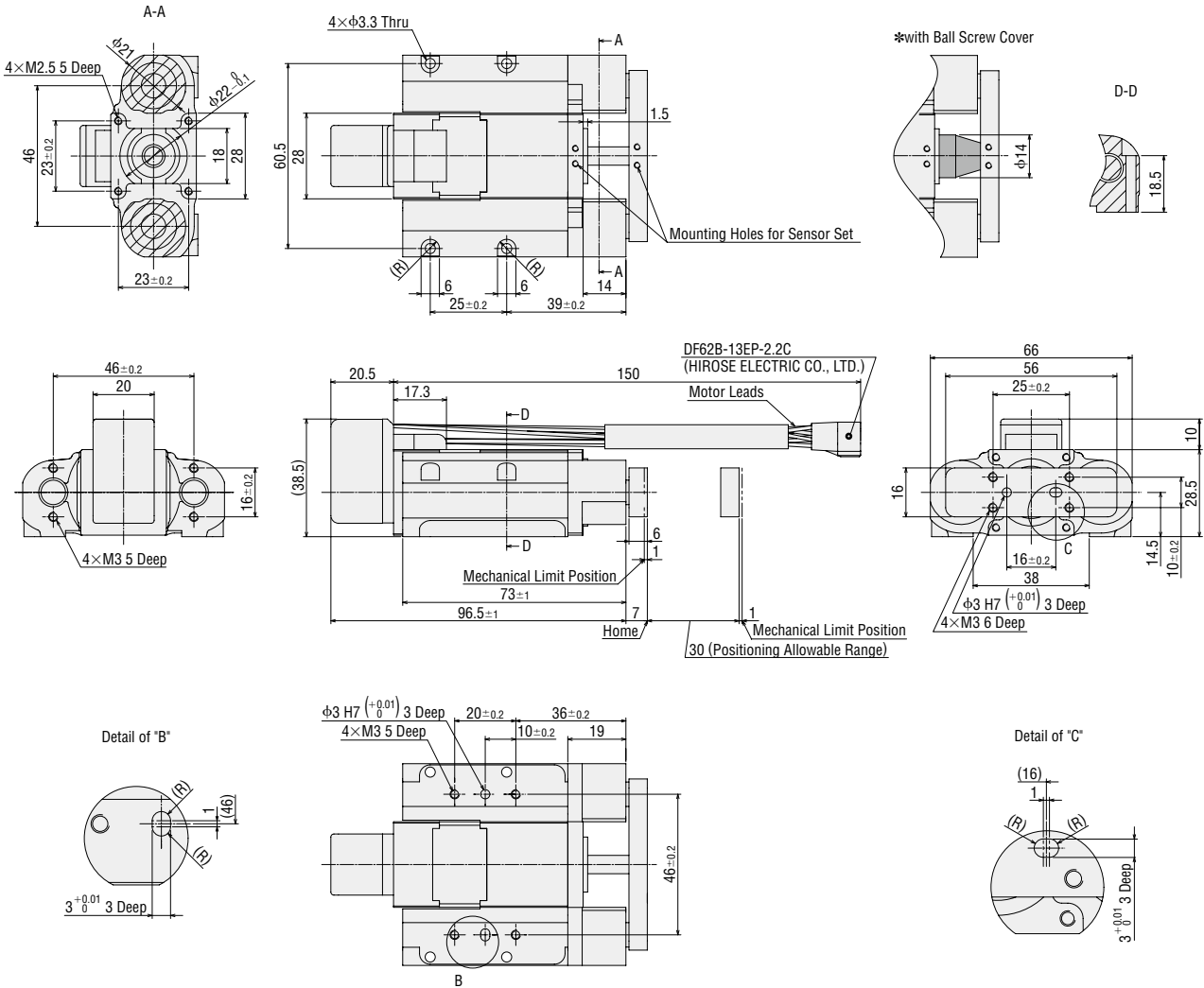

## Cable Outlet Direction

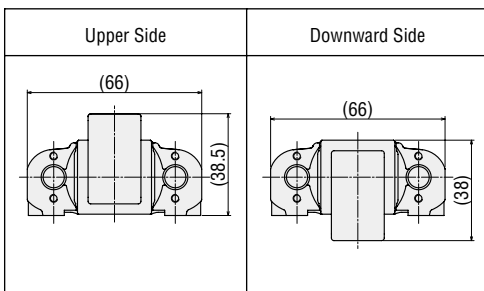

### Note

- The reference point can be freely selected within the stroke. It must be ensured that a minimum distance of 1 mm to the mechanical end positions is maintained.
- The color part  represents the ball screw cover.

## Rod Type

Mounting Plate	Product Name	Mass [kg]
without Mounting Plate	DR28R1B03-AZAK□	0.23
	DR28R1BC03-AZAK□	
	DR28R2.5B03-AZAK□	
	DR28R2.5BC03-AZAK□	
with Foot	DR28R1B03-AZAK□-P	0.26
	DR28R1BC03-AZAK□-P	
	DR28R2.5B03-AZAK□-P	
	DR28R2.5BC03-AZAK□-P	

● Either **U** (upper side), **D** (downward side), **R** (right side), or **L** (left side) indicating the cable outlet direction is entered where the box □ is located within the product name.

### ◇ Without Mounting Plate

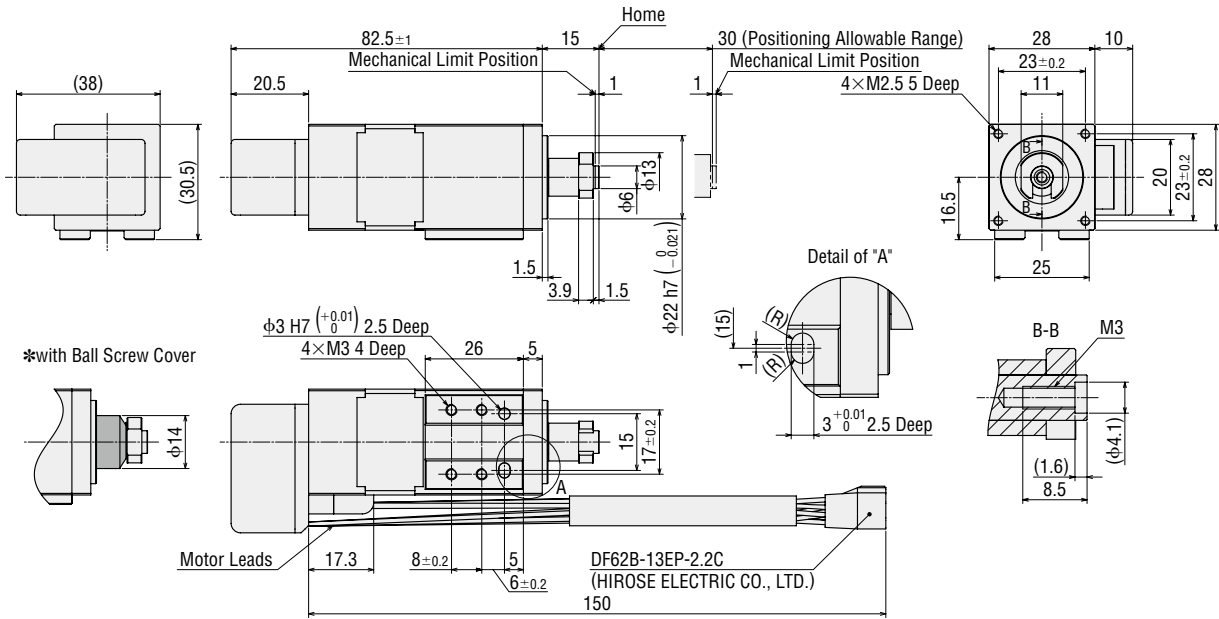

### ◇ Rod Type with Foot

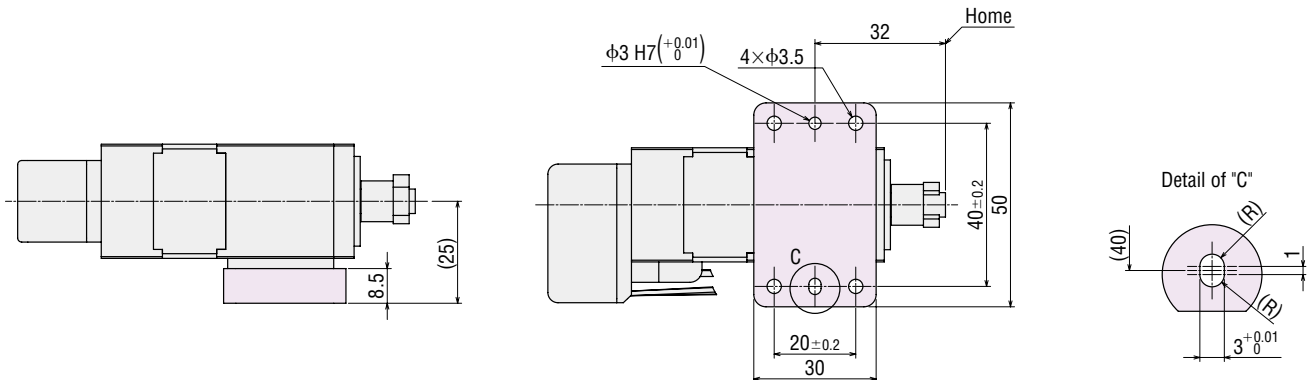

### Cable Outlet Direction

Upper Side	Downward Side	Right Side	Left Side

#### Note

- The reference point can be freely selected within the stroke. It must be ensured that a minimum distance of 1 mm to the mechanical end positions is maintained.
- The color part represents the ball screw cover.
- The color part represents the mounting plate.



# Accessories

## Sensor Sets

These are sensor sets dedicated to the **DR28** table type and rod type with guide. Photomicrosensor (with a sensor cable of 1 m), sensor plate, and shielding plate are included as a set. Screws needed for installation are also included.

● A sensor for detecting an overrun is not supplied with the product.



### Product Line

Applicable Product	Product Name	Sensor Output	List Price
Table Type	<b>PADR-SN28T</b>	NPN	53,00 €
	<b>PADR-SP28T</b>	PNP	
Rod Type with Guide	<b>PADR-SN28G</b>	NPN	53,00 €
	<b>PADR-SP28G</b>	PNP	

### Specifications

Product Name	<b>PADR-SN28T</b> <b>PADR-SN28G</b>	<b>PADR-SP28T</b> <b>PADR-SP28G</b>
Sensor Product Name	PM-U25 (Panasonic Industrial Devices SUNX Co., Ltd.)	PM-U25-P (Panasonic Industrial Devices SUNX Co., Ltd.)
Repetitive Positioning Accuracy	±0.01 mm (Measured value at a constant temperature)	
Power Supply Voltage	5 to 24 VDC ±10% Ripple (Peak to Peak) 10% max.	
Consumption Current	15 mA max.	
Control Output	NPN Transistor, Open-Collector Output 30 VDC max., 50 mA max. Residual Voltage: 2 VDC max. Load Current: 50 mA	PNP Transistor, Open-Collector Output 30 VDC max., 50 mA max. Residual Voltage: 2 VDC max. Load Current: 50 mA
Indicator LED	Detection Indication (Orange)	
Sensor Logic	Normally Open/Normally Closed (Possible to switch by connection)	
Cable	4-Core Cable 0.09 mm <sup>2</sup>	

### Sensor Set Installation

Set the operating conditions so that the motor surface temperature of the actuator is 55°C or lower.

### Reference Dimensions for Sensor Installation Position (All dimensions in mm)

#### Table Type

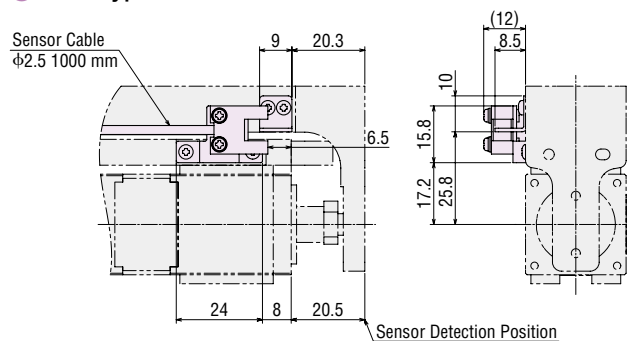

#### Rod Type with Guide

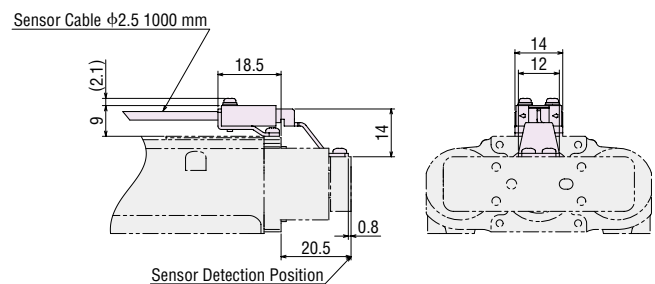

● For the table type product, the sensor and the shielding plate can also be installed on the opposite side of the dimensions.

● The color part represents the sensor set.

# Centering Aid

The centering aid supports the alignment of the mounting plate or the actuator for installation on a movable table.

## Product overview

Product Name	List Price
<b>PACS-DR28</b>	107,00 €



### Conditions for using the **PACS-DR28** centering aid

#### Front Mounting:

The design of the centering aid sets a distance of 15 mm between the table and the mounting surface of the actuator.

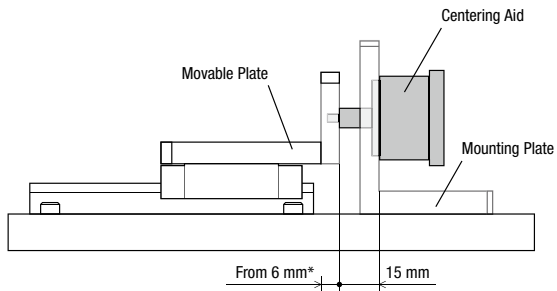

\*Required distance for adjustment.

#### Foot Mounting:

The design of the centering aid sets a distance of 32 mm between the table and the mounting surface of the actuator.

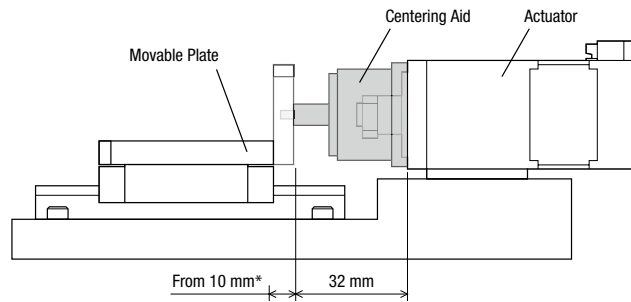

\*Required distance for adjustment or for inserting and removing the centering aid.



# Orientalmotor

These products are manufactured at plants certified with the international standards **ISO 9001** (for quality assurance) and **ISO 14001** (for systems of environmental management).

Specifications are subject to change without notice. This catalogue was published in May 2021.

## **ORIENTAL MOTOR (EUROPA) GmbH**

[www.orientalmotor.de](http://www.orientalmotor.de)

### **European Headquarters**

Schießstraße 44  
40549 Düsseldorf, Germany  
Tel: 0211-520 670 0 Fax: 0211-520 670 99



### **Spanish Office**

C/Caléndula 93 - Ed. E - Miniparc III  
28109 El Soto de La Moraleja,  
Alcobendas (Madrid), Spain  
Tel: +34 918 266 565  
[www.orientalmotor.es](http://www.orientalmotor.es)

## **ORIENTAL MOTOR (UK) LTD.**

[www.oriental-motor.co.uk](http://www.oriental-motor.co.uk)

### **UK Headquarters**

Unit 5, Faraday Office Park,  
Rankine Road, Basingstoke,  
Hampshire RG24 8AH, U.K.  
Tel: 01256-347 090 Fax: 01256-347 099



## **ORIENTAL MOTOR SWITZERLAND AG**

[www.orientalmotor.ch](http://www.orientalmotor.ch)

### **Switzerland Headquarters**

Badenerstrasse 13  
5200 Brugg AG, Switzerland  
Tel: 056-560 504 5 Fax: 056-560 504 7



## **ORIENTAL MOTOR ITALIA s.r.l.**

[www.orientalmotor.it](http://www.orientalmotor.it)

### **Italy Headquarters**

Via XXV Aprile 5  
20016 Pero (MI), Italy  
Tel: 02-939 063 46 Fax: 02-939 063 48



## **ORIENTAL MOTOR (FRANCE) SARL**

[www.orientalmotor.fr](http://www.orientalmotor.fr)

### **France Headquarters**

56, Rue des Hautes Pâtures  
92000 Nanterre, France  
Tel: 01-478 697 50 Fax: 01-478 245 16



**Other countries:** [www.orientalmotor.eu](http://www.orientalmotor.eu)

## **Customer Service Center (Support in German & English)**

00800-22 55 66 22\*  
CA LL OM CC

Mon-Thu: 08:00 - 16:30 CET Friday: 08:00 - 15:00 CET

\*Free Call Europe

[info@orientalmotor.de](mailto:info@orientalmotor.de)

For more information please contact: