



OPERATING MANUAL

Stepping Motor **αSTEP**

AZ Series Motor Edition

Table of contents

Introduction	1	Grounding the motor	9
Safety precautions	1	Inspection and maintenance	9
Precautions for use.....	2	General specifications	10
Preparation.....	3	Regulations and standards.....	10
Installation.....	5		

Introduction

■ Before use

Only qualified personnel of electrical and mechanical engineering should work with the product.
 Use the product correctly after thoroughly reading the "Safety precautions." In addition, be sure to observe the contents described in warning, caution, and note in this manual.
 The product described in this manual is designed and manufactured to be incorporated in general industrial equipment. Do not use for any other purpose. Oriental Motor Co., Ltd. is not responsible for any compensation for damage caused through failure to observe this warning.

■ Related operating manuals

For operating manuals not included with the product, contact your nearest Oriental Motor sales office or download from Oriental Motor Website Download Page.

Operating manual name	Included or not included with product
AZ Series OPERATING MANUAL Motor Edition (this document)	Not included
AZ Series/Motorized actuator equipped with AZ Series OPERATING MANUAL Function Edition	Not included
APPENDIX UL Standards for AZ Series	Included

Refer to the operating manual of the driver for contents not described in these manuals.

Safety precautions

The precautions described below are intended to ensure the safe and correct use of the product, and to prevent the customer and others from exposure to the risk of injury. Use the product only after carefully reading and fully understanding these instructions.

Description of signs

	Handling the product without observing the instructions that accompany a "WARNING" symbol may result in serious injury or death.
	Handling the product without observing the instructions that accompany a "CAUTION" symbol may result in injury or property damage.
	The items under this heading contain important handling instructions that the user should observe to ensure the safe use of the product.

Thank you for purchasing an Oriental Motor product. This Operating Manual describes product handling procedures and safety precautions.

- Please read it thoroughly to ensure safe operation.
- Always keep the manual where it is readily available.

Description of graphic symbols





	Indicates "prohibited" actions that must not be performed.
	Indicates "compulsory" actions that must be performed.

⚠ WARNING

	Do not use the motor in explosive or corrosive environments, in the presence of flammable gases, in places subjected to splashing water, or near combustibles. Doing so may result in fire, electric shock, or injury.
	Do not transport, install, connect, or inspect the motor while the power is supplied. Doing so may result in electric shock.
	Do not forcibly bend, pull, or pinch the cable. Doing so may result in fire or electric shock.
	Do not disassemble or modify the motor. Doing so may result in injury or damage to equipment.
	Assign qualified personnel to the task of installing, wiring, operating/controlling, inspecting, and troubleshooting the motor. Failure to do so may result in fire, electric shock, injury, or damage to equipment.
	Take measures to keep the moving part in position if the product is used in vertical operations such as elevating equipment. Failure to do so may result in injury or damage to equipment.
	Do not use the brake mechanism of the electromagnetic brake motor for braking or as a safety brake. Doing so may result in injury or damage to equipment.
	When an alarm is generated in the driver (any of the driver's protective functions is triggered), take measures to hold the moving part in a specific position since the motor stops and loses its holding torque. Failure to do so may result in injury or damage to equipment.
	Install the motor inside an enclosure. Failure to do so may result in electric shock or injury.
	The motor is Class I equipment. When installing the motor, install it inside an enclosure so that it is out of the direct reach of users. Be sure to ground if users can touch it. Failure to do so may result in electric shock.

⚠ CAUTION

	Do not use the motor beyond its specifications. Doing so may result in electric shock, injury, or damage to equipment.
	Keep your fingers and objects out of the openings in the motor. Failure to do so may result in fire, electric shock, or injury.
	Do not touch the motor during operation or immediately after stopping. Doing so may result in a skin burn(s).
	Do not carry the motor by holding the motor output shaft or motor cable. Doing so may result in injury.
	Keep the area around the motor free of combustible materials. Failure to do so may result in fire or a skin burn(s).
	Do not leave anything around the motor that would obstruct ventilation. Doing so may result in damage to equipment.
	Do not touch the rotating part (output shaft) during operation. Doing so may result in injury.

 CAUTION	
	Do not touch the terminals while conducting the insulation resistance measurement or the dielectric strength test. Doing so may cause electric shock.
	Provide a cover over the rotating part (output shaft) of the motor. Failure to do so may result in injury.
	Use a motor and a driver only in the specified combination. An incorrect combination may cause a fire.
	Provide an emergency stop device or emergency stop circuit external to the equipment so that the entire equipment will operate safely in the event of a system failure or malfunction. Failure to do so may result in injury.
	The motor surface temperature may exceed 70 °C (158 °F) even under normal operating conditions. If the operator is allowed to approach the motor in operation, affix a warning label shown in the figure on a conspicuous position. Failure to do so may result in a skin burn(s).
	 Warning label

Precautions for use

This section covers restrictions and requirements the user should consider when using the product.

- **Be sure to use our cable to connect the motor and driver.**

Check on the Oriental Motor Website for the model name of cables.

- **When conducting the insulation resistance measurement or the dielectric strength test, be sure to separate the connection between the motor and the driver.**

Conducting the insulation resistance measurement or dielectric strength test with the motor and driver connected may result in damage to the product.

- **Make sure not to hit or apply a strong impact on the motor output shaft or the encoder (ABZO sensor).**

Applying a strong impact on the motor output shaft or the encoder (ABZO sensor) may cause encoder (ABZO sensor) damage or motor malfunction. The warning label shown in the right is attached on the motor.

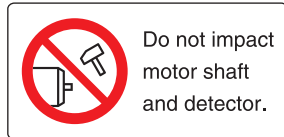

Warning label

- **Do not move the encoder (ABZO sensor) toward a strong magnetic field.**

A magnetic sensor is built into the encoder (ABZO sensor). If the motor is installed close to equipment which generates a strong magnetic field, the encoder (ABZO sensor) may break or malfunction. Especially, since the motors of frame size 20 mm (0.79 in.) and 28 mm (1.10 in.) are easily affected by a magnetic field, so make sure the environment at transportation and storage as well as the installation location in use. Keep the magnetic flux density on the surface of the encoder (ABZO sensor) so as not to exceed the values in the table.

Motor frame size	Magnetic flux density	
	When transporting and storing	When operating
28 mm (1.10 in.) or less	5 mT	2 mT *
42 mm (1.65 in.) or more	10 mT	10 mT

* When the magnetic flux density is exceeding 1 mT and 2 mT or less, use in an environment where the operating ambient temperature is exceeding 20 °C (68 °F) and 40 °C (104 °F) or less.

- **Meshing noise of mechanical sensor**

A gear type mechanical sensor is built into the encoder (ABZO sensor). Although the meshing noise of gears may generate, it is not malfunction.

- **Do not apply a radial load and axial load in excess of the specified permissible limit**

Continuing to operate the motor under an excessive radial load or axial load may damage the bearings (ball bearings). Be sure to operate the motor within the specified permissible limit of radial load and axial load.

- **Use the motor in conditions where the motor surface temperature does not exceed 80 °C (176 °F).**

The surface temperature on the motor case may exceed 80 °C (176 °F) depending on operating conditions such as ambient temperature, operating speed, duty cycle, and others. In order to protect the encoder (ABZO sensor), use the motor so that the surface temperature on the motor case does not exceed 80 °C (176 °F). If the encoder (ABZO sensor) temperature reaches the upper limit, the motor overheat protection alarm will generate. Use the geared motor in conditions where the gear case temperature does not exceed 70 °C (158 °F), in order to prevent deterioration of grease and parts in the gear case.

- **Holding torque at standstill**

The motor holding torque is reduced by the current cutback function of the driver at motor standstill. When selecting a motor, check the holding torque at motor standstill in the specifications on the catalog.

- **Do not use the electromagnetic brake to reduce speed or as a safety brake.**

Do not use the electromagnetic brake as a means to decelerate and stop the motor. The brake hub of the electromagnetic brake will wear significantly and the braking force will drop. Since the power off activated type electromagnetic brake is equipped, it helps maintain the position of the load when the power is cut off, but this brake cannot securely hold the load in place. Accordingly, do not use the electromagnetic brake as a safety brake. To use the electromagnetic brake to hold the load in place, do so after the motor has stopped.

- **Noise elimination measures**

For measures with regard to noise, refer to the operating manual of the driver.

- **Make sure to provide measures so that the key is not flown off when operating the motor with key in a state where a load is not installed.**

Flying off the key may result in injury or damage to equipment.

- **Grease of encoder (ABZO sensor) and geared motor**

On rare occasions, a small amount of grease may ooze out from the following places.

- Encoder (ABZO sensor) mechanical part [motors of frame size 20 mm (0.79 in.) and 28 mm (1.10 in.)]
- Geared motor

If there is concern over possible environmental damage resulting from the leakage of grease, check for grease stains during regular inspections. Alternatively, install an oil pan or other device to prevent leakage from causing further damage. Oil leakage may lead to problems in the customer's equipment or products.

- **Peak torque of geared motor**

Always operate the geared motor under a load not exceeding the peak torque. If the load exceeds the peak torque, the gear will be damaged.

- **Rotation direction of the gear output shaft**

The relationship between the rotation direction of the motor output shaft and that of the gear output shaft changes as follows, depending on the gear type and gear ratio.

Type of gear	Gear ratio	Rotation direction (relative to the motor rotation direction)
TS geared	3,6, 7,2, 10	Same direction
	20, 30	Opposite direction
FC geared, PS geared, HPG geared	All gear ratios	Same direction
Harmonic geared	All gear ratios	Opposite direction

- Do not perform push-motion operation with geared motor.

Doing so may cause damage to the motor or gear part.

■ Notes when the connection cable is used

Note the following points when our cable is used.

• When inserting the connector

Hold the connector main body, and insert it in straight securely. Inserting the connector in an inclined state may result in damage to terminals or a connection failure.

• When pulling out the connector

Pull out the connector in straight while releasing the lock part of the connector. Pulling out the connector with holding the cable may result in damage to the connector.

• Bending radius of cable

Use the cable in a state where the bending radius of the cable is more than six times of the cable diameter. Do not bend the lead wires part or fix it with a clamp. Doing so may cause damage to the connector.

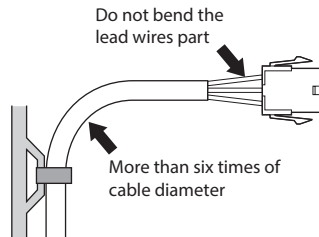

• How to fix the cable

Fix the cable at the positions near the connector so that no stress is applied on the connector part.

Take measures so that no stress is applied on the connector by using wide clamps or by fixing at two places.

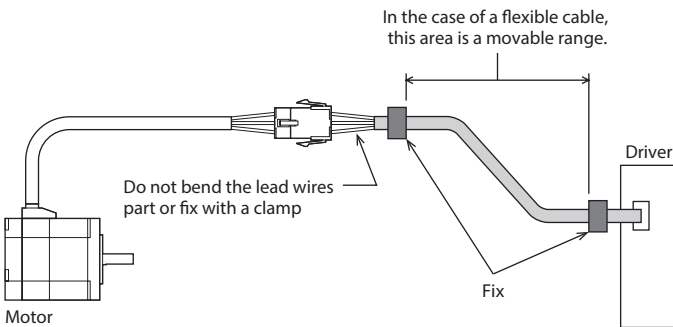

Preparation

■ Checking the product

Verify that the items listed below are included. Report any missing or damaged items to the Oriental Motor sales office from which you purchased the product.

- Motor 1 unit
- Parallel key 1 pc. *1
- Motor mounting screw (M4)..... 4 pcs. *2
- Motor mounting screw (M8)..... 4 pcs. *3
- Instructions and Precautions for Safe Use..... 1 copy
- APPENDIX UL Standards for **AZ** Series 1 copy *4

*1 Included with standard type with key and geared type (except for the **AZM24-PS**, **AZM24-HS**, **AZM46-TS** geared type, and the **HPG** geared flange output type)

*2 Included with **AZM66-TS**.

*3 Included with **AZM98-TS**.

*4 Included with products conform to the UL Standards.

■ How to identify the product model

Check the model name of the motor against the number shown on the nameplate.

● Standard type

AZM 6 6 A 0 K F
1 2 3 4 5 6 7

● Geared type (excluding the FC geared type)

AZM 6 6 A C - HP 15 F
1 2 3 4 6 8 9 10

1	Series name	AZM: AZ Sereis motor
2	Motor frame size	1: 20 mm (0.79 in.) 2: 28 mm (1.10 in.) [30 mm (1.18 in.) for Harmonic geared type] 4: 42 mm (1.65 in.) [40 mm (1.57 in.) for HPG geared type] 6: 60 mm (2.36 in.) 9: 85 mm (3.35 in.) [90 mm (3.54 in.) for geared type]
3	Motor length	
4	Motor shaft features	A: Single shaft M: With electromagnetic brake
5	Additional function	0: Round shaft type 1: With key Blank: Round shaft with shaft flat on one side
6	Motor power supply input	C: AC power input type K: DC power input type
7	Cable outlet direction	F: Horizontal direction with respect to motor (DC power input type only)
8	Type of gear	TS: TS geared PS: PS geared HP: HPG geared HS: Harmonic geared
9	Gear ratio	
10	Varies depending on the gear type.	<ul style="list-style-type: none"> • TS geared type: Cable outlet direction * U: Upward direction R: Rightward direction L: Leftward direction Blank: Downward direction • HPG geared type: Output shaft type Blank: Shaft output type F: Flange output type

* The cable outlet direction represents the one as viewed from the output shaft side in a state of placing it upward.

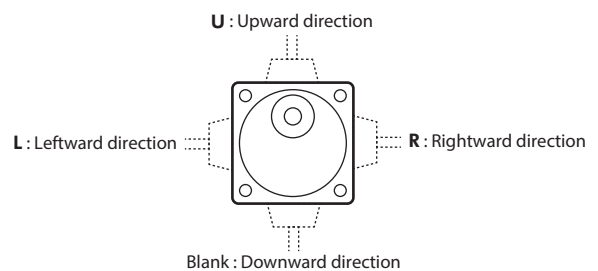

● FC geared type

AZM 6 6 A C - FC 7.2 U A
 1 2 3 4 5 6 7 8 9

1	Series name	AZM: AZ Sereis motor
2	Motor frame size	4: 42 mm (1.65 in.) 6: 60 mm (2.36 in.)
3	Motor length	
4	Motor shaft features	A: Single shaft M: With electromagnetic brake
5	Motor power supply input	C: AC power input type K: DC power input type
6	Type of gear	FC: FC geared
7	Gear ratio	
8	Cable outlet direction *	D: Downward direction U: Upward direction
9	Motor identification	A: Solid shaft

* Check the cable outlet direction as shown in the figure.

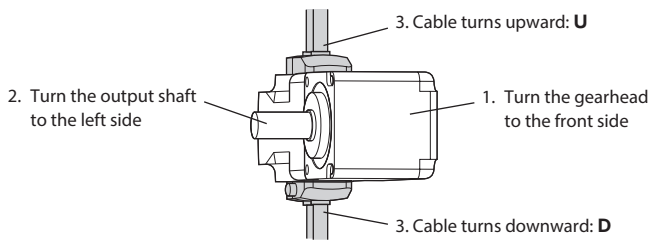

■ Information about nameplate

The figure shows an example.

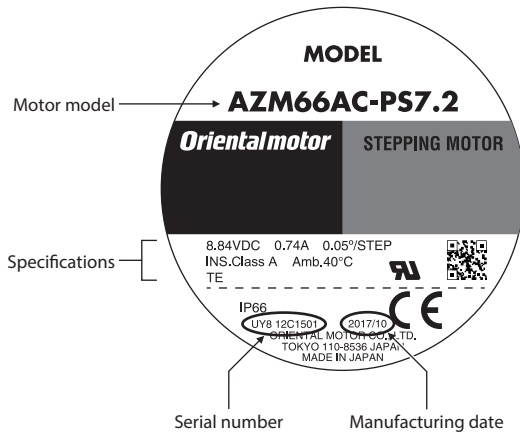

The position describing the information may vary depending on the product.

■ Names of parts

● Standard type (Example: AZM14AK)

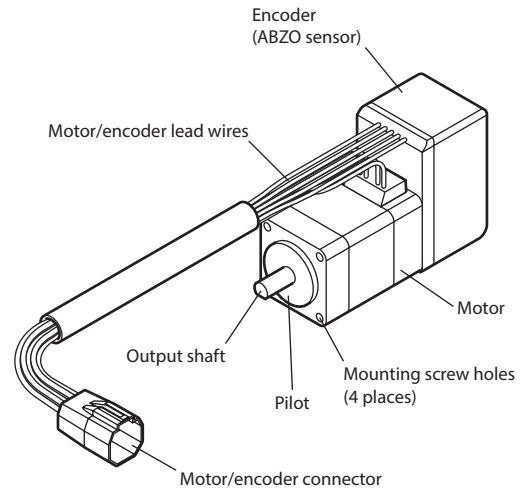

● Standard type with electromagnetic brake (Example: AZM66MC)

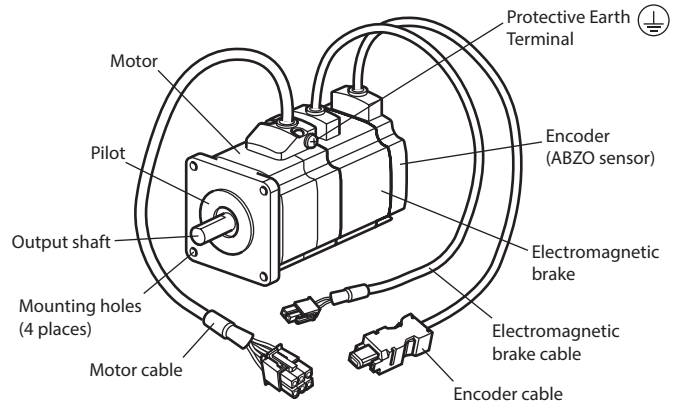

● Standard type Cable outlet in horizontal direction (Example: AZM66MOKF)

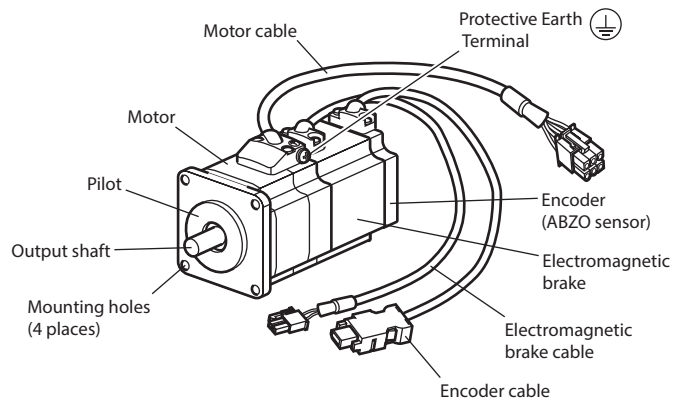

● **HPG geared flange output type**
(Example: AZM66AC-HP5F)

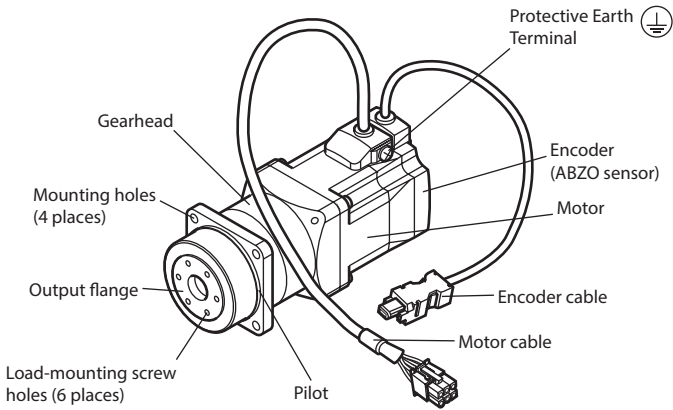

● **FC geared type** (Example: AZM66AC-FC7.2UA)

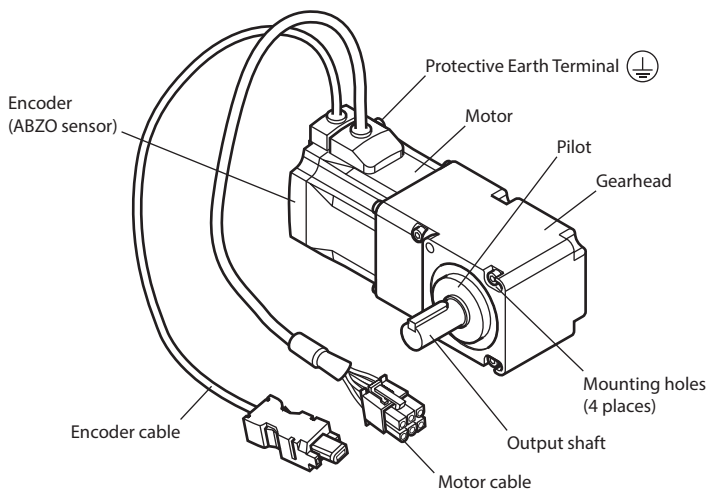

Installation

■ **Installation location**

The motor is designed and manufactured to be incorporated in equipment. Install it in a well-ventilated location that provides easy access for inspection. The location must also satisfy the following conditions:

- Inside an enclosure that is installed indoors (provide vent holes)
- Operating ambient temperature: 0 to +40 °C (+32 to +104 °F) (non-freezing)
- Operating ambient humidity 85 % or less (non-condensing)
- Area free of explosive atmosphere or toxic gas (such as sulfuric gas) or liquid
- Area not exposed to direct sun
- Area free of excessive amount of dust, iron particles or the like
- Area not subject to splashing water (rain, water droplets), oil (oil droplets) or other liquids
- Area free of excessive salt
- Area not subject to continuous vibrations or excessive shocks
- Area free of excessive electromagnetic noise (from welders, power machinery, etc.)
- Area free of radioactive materials, magnetic fields or vacuum
- 1,000 m (3,300 ft.) or lower above sea level

● **If a motor is installed in an environment where a magnetic field is generated**

A magnetic sensor is built into the encoder (ABZO sensor). If the motor is installed close to equipment which generates a strong magnetic field, the encoder (ABZO sensor) may break or malfunction. Keep the magnetic flux density on the surface of the encoder (ABZO sensor) so as not to exceed the values in the table.

Motor frame size	Magnetic flux density
28 mm (1.10 in.) or less	2 mT *
42 mm (1.65 in.) or more	10 mT

* When the magnetic flux density is exceeding 1 mT and 2 mT or less, use in an environment where the operating ambient temperature is exceeding 20 °C (68 °F) and 40 °C (104 °F) or less.



Do not install the motor close to equipment which generates a strong magnetic field.

■ **Installation method**

The motor can be installed in any direction. To allow for heat dissipation and prevent vibration, install the motor on a metal surface of sufficient strength.

● **Installation method A**

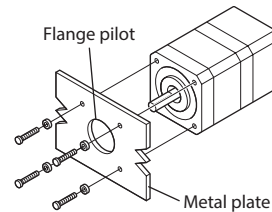

● **Installation method B**

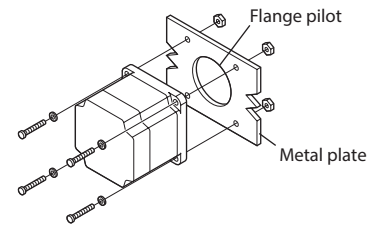

● **Installation method B (For FC geared type)**

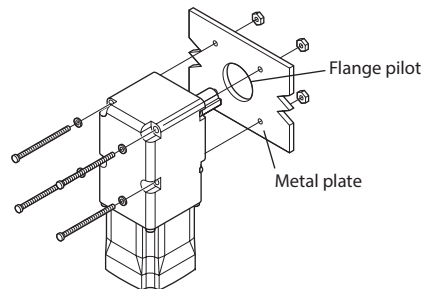

● **Installation for motors of frame size 20 mm (0.79 in.) and 28 mm (1.10 in.)**

Since the encoder (ABZO sensor) for the motors of frame size 20 mm (0.79 in.) and 28 mm (1.10 in.) are easily affected by a magnetic field, make sure the installation location.

When motors are installed side by side, ensure the distance among motors of more than the frame size in horizontal and vertical directions.

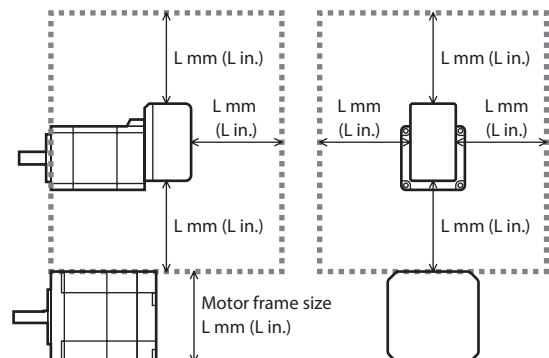

* Ensure the distance of more than the frame size [L mm (L in.)].

● Nominal size, tightening torque and installation method

● Standard type

Motor model	Nominal size	Tightening torque [N·m (oz-in)]	Effective depth of screw thread [mm (in.)]	Installation method
AZM14 AZM15	M2	0.25 (35)	2.5 (0.098)	A
AZM24 AZM26	M2.5	0.5 (71)	2.5 (0.098)	A
AZM46 AZM48	M3	1 (142)	4.5 (0.177)	A
AZM66 AZM69	M4	2 (280)	–	B
AZM98 AZM911	M6	3 (420)	–	B

● TS geared type

Motor model	Nominal size	Tightening torque [N·m (oz-in)]	Effective depth of screw thread [mm (in.)]	Installation method
AZM46	M4	1.4 (198)	8 (0.315)	A
AZM66	M4	1.4 (198)	–	B
AZM98	M8	4 (560)	–	B

● FC geared type

Motor model	Nominal size	Tightening torque [N·m (oz-in)]	Effective depth of screw thread [mm (in.)]	Installation method
AZM46	M4	2 (280)	–	B
AZM66	M5	2.5 (350)	–	B

● PS geared type

Motor model	Nominal size	Tightening torque [N·m (oz-in)]	Effective depth of screw thread [mm (in.)]	Installation method
AZM24	M3	1 (142)	6 (0.236)	A
AZM46	M4	2 (280)	8 (0.315)	A
AZM66	M5	2.5 (350)	10 (0.394)	A
AZM98	M8	4 (560)	15 (0.591)	A

● HPG geared type

Motor model	Nominal size	Tightening torque [N·m (oz-in)]	Effective depth of screw thread [mm (in.)]	Installation method
AZM46	M3	1 (142)	–	B
AZM66	M5	2.5 (350)	–	B
AZM98	M8	4 (560)	–	B

● Harmonic geared type

Motor model	Nominal size	Tightening torque [N·m (oz-in)]	Effective depth of screw thread [mm (in.)]	Installation method
AZM24	M3	1 (142)	6 (0.236)	A
AZM46	M4	2 (280)	8 (0.315)	A
AZM66	M5	2.5 (350)	10 (0.394)	A
AZM98	M8	4 (560)	–	B

■ Installing a load

When installing a load to the motor, align the centers of the motor output shaft and load shaft. When installing a coupling or pulley on the motor output shaft, do so without damaging the output shaft and bearings (ball bearings).

● Electromagnetic brake motor

To release the electromagnetic brake and install the load, a DC power supply is needed to power the electromagnetic brake. Connect the DC power supply (24 VDC±5 %) to the motor using the “cable for electromagnetic brake.”

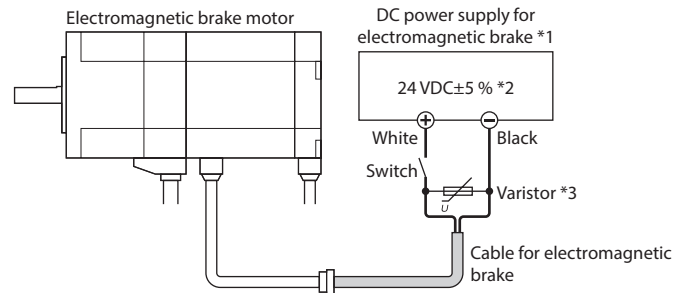

*1 The power supply current capacities are as follows.

AZM46: 0.08 A or more

AZM66, AZM69, AZM98: 0.25 A or more

*2 If the distance between the motor and driver is extended to 20 m (65.6 ft.), use a power supply of 24 VDC±4 %.

*3 Provide a varistor to protect the contact of the switch or to prevent electrical noise. [Recommended varistor: Z15D121 (SEMITEC Corporation)].

● HPG geared flange output type

When installing a load on the **HPG** geared flange output type, use the load-mounting screw holes on the output flange.

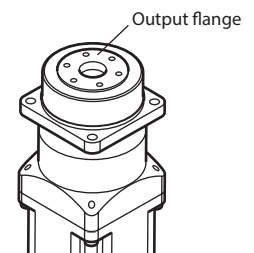

Load-mounting screw hole

Motor model	Number of screw holes	Nominal size	Tightening torque [N·m (oz-in)]	Effective depth of screw thread [mm (in.)]
AZM46	3 places	M4	4.5 (630)	6 (0.236)
AZM66	6 places	M4	4.5 (630)	7 (0.276)
AZM98	6 places	M6	15.3 (2,100)	10 (0.394)



Since the tightening torque for the load-mounting screw is large, using a mechanically weak load or screws may cause damage. Satisfy the following conditions for the load and mounting screws. Also, be sure to tighten with the specified torque.

Material of load: Steel

Mounting screw: Use a screw which tensile strength ranking is 12.9 or higher

● When a load is installed on the flange face of the Harmonic geared type

With a Harmonic geared type (excluding **AZM98**), a load can be installed directly on the gear using the load-mounting screw holes provided on the flange surface.

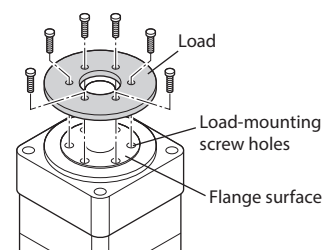

Load-mounting screw hole

Motor model	Nominal size	Number of screws	Tightening torque [N·m (oz-in)]	Effective depth of screw thread [mm (in.)]
AZM24	M3	4	1.4 (198)	4 (0.16)
AZM46	M3	6	1.4 (198)	5 (0.20)
AZM66	M4	6	2.5 (350)	6 (0.24)



- When installing a load on the flange surface, the load cannot be mounted using the key slot in the output shaft.
- Design an appropriate installation layout so that the load will not contact the metal plate or screws used for installing the motor.

When a coupling or a pulley is installed

When installing a coupling or pulley on the output shaft, do not apply a strong force to the output shaft. For the standard motor, in particular, a mechanical impact may cause damage to the encoder (ABZO sensor). When installing a coupling or pulley on the standard motor with a parallel key, utilize the screw hole on the shaft end.

- Install a coupling (pulley) on the motor output shaft.
- Install a screw, nut, and washer on the end of the output shaft, and push the coupling (pulley) and secure with tightening the screw.

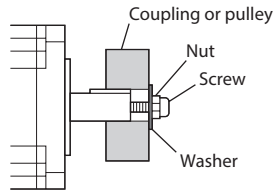

Permissible radial load, permissible axial load and permissible moment load



Failure due to fatigue may occur when the motor output shaft and the bearings (ball bearings) are subject to repeated loading by a radial or axial load that is in excess of the permissible limit.



The permissible radial load and permissible axial load of the **PS** geared type and **HPG** geared type represent the value that the service life of the gear part satisfies 20,000 hours when either of the radial load or axial load is applied to the gear output shaft.

Permissible radial load

Standard type

Motor model	Permissible radial load [N (lb.)]				
	Distance from the tip of motor output shaft [mm (in.)]				
	0 (0)	5 (0.2)	10 (0.39)	15 (0.59)	20 (0.79)
AZM14 AZM15	12 (2.7)	15 (3.3)	–	–	–
AZM24 AZM26	25 (5.6)	34 (7.6)	52 (11.7)	–	–
AZM46	35 (7.8)	44 (9.9)	58 (13)	85 (19.1)	–
AZM48	30 (6.7)	35 (7.8)	44 (9.9)	58 (13)	85 (19.1)
AZM66 AZM69	90 (20)	100 (22)	130 (29)	180 (40)	270 (60)
AZM98 AZM911	260 (58)	290 (65)	340 (76)	390 (87)	480 (108)

TS geared type

Motor model	Gear ratio	Permissible radial load [N (lb.)]				
		Distance from the tip of motor output shaft [mm (in.)]				
		0 (0)	5 (0.2)	10 (0.39)	15 (0.59)	20 (0.79)
AZM46	3.6, 7.2, 10	20 (4.5)	30 (6.7)	40 (9)	50 (11.2)	–
	20, 30	40 (9)	50 (11.2)	60 (13.5)	70 (15.7)	–
AZM66	3.6, 7.2, 10	120 (27)	135 (30)	150 (33)	165 (37)	180 (40)
	20, 30	170 (38)	185 (41)	200 (45)	215 (48)	230 (51)
AZM98	3.6, 7.2, 10	300 (67)	325 (73)	350 (78)	375 (84)	400 (90)
	20, 30	400 (90)	450 (101)	500 (112)	550 (123)	600 (135)

FC geared type

Motor model	Gear ratio	Permissible radial load [N (lb.)]				
		Distance from the tip of motor output shaft [mm (in.)]				
		0 (0)	5 (0.2)	10 (0.39)	15 (0.59)	20 (0.79)
AZM46	All gear ratios	180 (40)	200 (45)	220 (49)	250 (56)	–
AZM66	All gear ratios	270 (60)	290 (65)	310 (69)	330 (74)	350 (78)

PS geared type

Motor model	Gear ratio	Permissible radial load [N (lb.)]				
		Distance from the tip of motor output shaft [mm (in.)]				
		0 (0)	5 (0.2)	10 (0.39)	15 (0.59)	20 (0.79)
AZM24	All gear ratios	45 (10.1)	60 (13.5)	80 (18)	100 (22)	–
	5	70 (15.7)	80 (18)	95 (21)	120 (27)	–
AZM46	7.2	80 (18)	90 (20)	110 (24)	140 (31)	–
	10	85 (19.1)	100 (22)	120 (27)	150 (33)	–
	25	120 (27)	140 (31)	170 (38)	210 (47)	–
	36	130 (29)	160 (36)	190 (42)	240 (54)	–
	50	150 (33)	170 (38)	210 (47)	260 (58)	–
AZM66	5	170 (38)	200 (45)	230 (51)	270 (60)	320 (72)
	7.2	200 (45)	220 (49)	260 (58)	310 (69)	370 (83)
	10	220 (49)	250 (56)	290 (65)	350 (78)	410 (92)
	25	300 (67)	340 (76)	400 (90)	470 (105)	560 (126)
	36	340 (76)	380 (85)	450 (101)	530 (119)	630 (141)
AZM98	50	380 (85)	430 (96)	500 (112)	600 (135)	700 (157)
	5	380 (85)	420 (94)	470 (105)	540 (121)	630 (141)
	7.2	430 (96)	470 (105)	530 (119)	610 (137)	710 (159)
	10	480 (108)	530 (119)	590 (132)	680 (153)	790 (177)
	25	650 (146)	720 (162)	810 (182)	920 (200)	1,070 (240)
	36	730 (164)	810 (182)	910 (200)	1,040 (230)	1,210 (270)
	50	820 (184)	910 (200)	1,020 (220)	1,160 (260)	1,350 (300)

HPG geared shaft output type

Motor model	Gear ratio	Permissible radial load [N (lb.)]				
		Distance from the tip of motor output shaft [mm (in.)]				
		0 (0)	5 (0.2)	10 (0.39)	15 (0.59)	20 (0.79)
AZM46	5	150 (33)	170 (38)	190 (42)	230 (51)	270 (60)
	9	180 (40)	200 (45)	230 (51)	270 (60)	320 (72)
AZM66	5	250 (56)	270 (60)	300 (67)	330 (74)	360 (81)
	15	360 (81)	380 (85)	420 (94)	460 (103)	510 (114)
AZM98	5	600 (135)	630 (141)	670 (150)	710 (159)	750 (168)
	15	830 (186)	880 (198)	930 (200)	980 (220)	1,050 (230)

• Harmonic geared type

Motor model	Gear ratio	Permissible radial load [N (lb.)]				
		Distance from the tip of motor output shaft [mm (in.)]				
		0 (0)	5 (0.2)	10 (0.39)	15 (0.59)	20 (0.79)
AZM24	All gear ratios	100 (22)	135 (30)	175 (39)	250 (56)	–
AZM46		180 (40)	220 (49)	270 (60)	360 (81)	510 (114)
AZM66		320 (72)	370 (83)	440 (99)	550 (123)	720 (162)
AZM98		1,090 (240)	1,150 (250)	1,230 (270)	1,310 (290)	1,410 (310)

● Permissible axial load

Type	Motor model	Gear ratio	Permissible axial load [N (lb.)]
Standard	AZM14 AZM15	–	3 (0.67)
	AZM24 AZM26		5 (1.12)
	AZM46 AZM48		15 (3.3)
	AZM66 AZM69		30 (6.7)
	AZM98 AZM911		60 (13.5)
TS geared	AZM46	All gear ratios	15 (3.3)
	AZM66		40 (9)
	AZM98		150 (33)
FC geared	AZM46	All gear ratios	100 (22)
	AZM66		200 (45)
PS geared	AZM24	All gear ratios	40 (9)
	AZM46		100 (22)
	AZM66		200 (45)
	AZM98		600 (135)
HPG geared	AZM46	5	430 (96)
		9	510 (114)
	AZM66	5	700 (157)
		15	980 (220)
		AZM98	5
15	2,030 (450)		
Harmonic geared	AZM24	All gear ratios	140 (31)
	AZM46		220 (49)
	AZM66		450 (101)
	AZM98		1,300 (290)

● Permissible moment load

When installing an arm or table on the flange surface, calculate the moment load using the formula below if the flange surface receives any eccentric load. The moment load should not exceed the permissible value specified in the table.

• HPG geared flange output type

Motor model	Gear ratio	Permissible moment load [N·m (oz-in)]
AZM46	5	4.9 (43)
	9	5.9 (52)
AZM66	5	12 (106)
	15	17.2 (152)
AZM98	5	38.7 (340)
	15	53.5 (470)



The permissible moment load of the HPG geared type represents the value that the service life of the gear part satisfies 20,000 hours.

How to read a code

- m: Mass of a load (kg)
- g: Gravitational acceleration (m/s²)
- F: External force (N)
- L: Overhang distance (m)
- a: Constant (m)
- ΔF: Load applied on the output flange surface (N)
- Fs: Permissible axial load (N)
- ΔM: Load moment (N·m)
- M: Permissible moment load (N·m)

Example 1; When an external force F(N) is applied on a position overhanging by L (m) from the center of the output flange in the horizontal direction

- Load moment
 $\Delta M = F \cdot L$
 $\Delta M \leq M$
- Axial load
 $\Delta F = F + m \cdot g$
 $\Delta F \leq F_s$

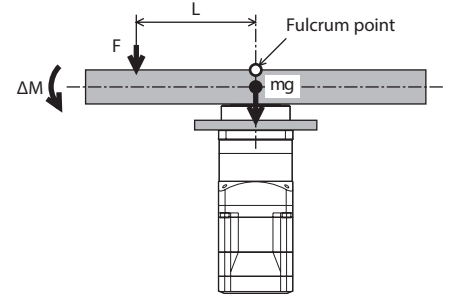

Example 2; When an external force F(N) is applied on a position overhanging by L (m) from the output flange mounting surface in the vertical direction

- Load moment
 $\Delta M = F \cdot (L + a)$
 $\Delta M \leq M$
- Axial load
 $\Delta F = m \cdot g$
 $\Delta F \leq F_s$

Motor model	Coefficient "a"
AZM46	0.006
AZM66	0.011
AZM98	0.0115

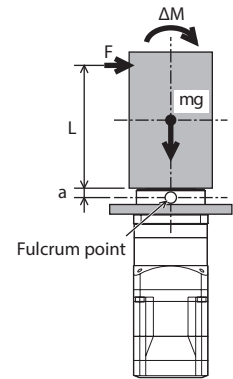

• Harmonic geared type

The **AZM98** type is excluded.

Motor model	Permissible moment load (N·m)
AZM24	2.9
AZM46	5.6
AZM66	11.6

Calculate the axial load and load moment for the Harmonic geared type using the International System of Units (N, N·m).

How to read a code

- m: Mass of a load (kg)
- g: Gravitational acceleration (m/s²)
- F: External force (N)
- L: Overhang distance (m)
- a: Constant (m)
- ΔF: Load applied on the output flange surface (N)
- Fs: Permissible axial load (N)
- ΔM: Load moment (N·m)
- M: Permissible moment load (N·m)

Example 1; When an external force F(N) is applied on a position overhanging by L (m) from the center of the output flange in the horizontal direction

- Load moment
 $\Delta M = F \cdot L$
 $\Delta M \leq M$
- Axial load
 $\Delta F = F + m \cdot g$
 $\Delta F \leq F_s$

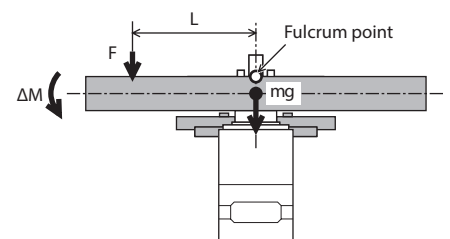

Example 2; When an external force F(N) is applied on a position overhanging by L (m) from the output flange mounting surface in the vertical direction

- Load moment
 $\Delta M = F \cdot (L + a)$
 $\Delta M \leq M$
- Axial load
 $\Delta F = m \cdot g$
 $\Delta F \leq F_s$

Motor model	Coefficient "a"
AZM24	0.0073
AZM46	0.009
AZM66	0.0114

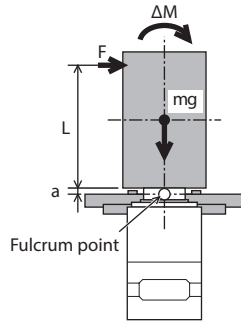

Grounding the motor

The grounding method of the motor varies depending on the driver input power. Check the table and ground using a suitable method. Be sure to ground the driver.

Grounding method	Driver input voltage		
	100-120 VAC 200-240 VAC	24 VDC	48 VDC
1) Protective Earth Terminal of the driver	Required to ground	Required to ground	Required to ground
2) Grounding wire of the motor	Required to ground	Not required	Not required
3) Protective Earth Terminal of the motor	*	Not required	*

* Ground if the grounding resistance of the standards that applies to the equipment is not satisfied.

1) Grounding the Protective Earth Terminal of the driver

Connect the motor to the driver, and surely ground the Protective Earth Terminal of the driver. Refer to the operating manual of the driver for how to ground. The figure shows the DC power input type.

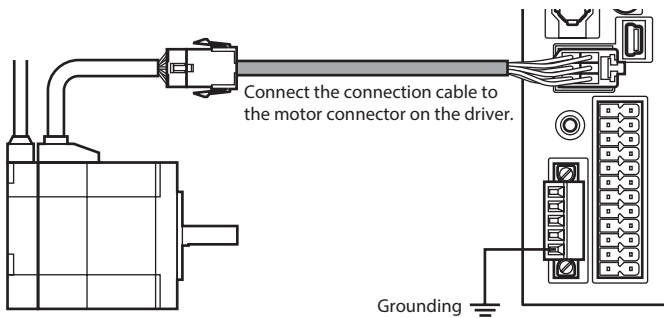

2) Grounding the grounding wire of the motor [AC power input type only]

Connect the grounding wire of the "cable for motor" to the driver Protective Earth Terminal.

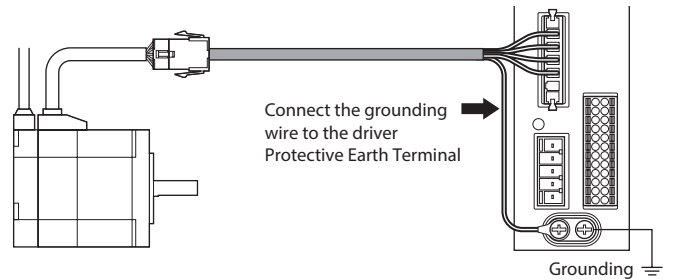

3) Grounding the Protective Earth Terminal of the motor

Be sure to ground the Protective Earth Terminal of the motor.

Grounding wire: AWG18 (0.75 mm²) or more
 Nominal size: M4

Tightening torque: 1.2 N·m (170 oz-in)

To ground the motor, use a round terminal, screw, and washer.

Ground wires and crimp terminals are not included.

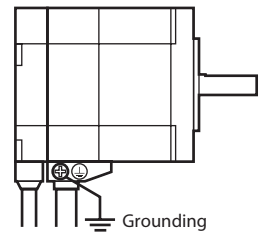

Inspection and maintenance

Inspection

It is recommended that periodic inspections would be conducted for the items listed below after each operation of the motor. If an abnormal condition is noted, discontinue any use and contact your nearest Oriental Motor sales office.

Inspection item

- Check if any of the screws having installed the motor is loose.
- Check if an unusual noise is generated from a bearing part (ball bearings) of the motor.
- Check if a damage or stress is applied on the cable.
- Check if any of the connection parts of the driver is loose.
- Check if the motor output shaft and the load shaft are out of alignment.

Warranty

Check on the Oriental Motor Website or General Catalog for the product warranty.

Disposal

Dispose the product correctly in accordance with laws and regulations, or instructions of local governments.

General specifications

Degree of protection	Excluding the mounting surface and connectors. IP40: AZM14, AZM15, AZM24, AZM26, AZM46 (*1), AZM48 (*1), AZM66 (*1), AZM69 (*1) IP66: Motors other than the above types	
Operation environment	Ambient temperature	0 to +40 °C (+32 to +104 °F) (non-freezing) *2
	Humidity	85 % or less (non-condensing)
	Altitude	Up to 1,000 m (3,300 ft.) above sea level
	Surrounding atmosphere	No corrosive gas, dust, water or oil
Storage environment	Ambient temperature	-20 to +60 °C (-4 to +140 °F) (non-freezing)
	Humidity	85 % or less (non-condensing)
Shipping environment	Altitude	Up to 3,000 m (10,000 ft.) above sea level
	Surrounding atmosphere	No corrosive gas, dust, water or oil
Insulation resistance	100 MΩ or more when 500 VDC megger is applied between the following places: • Case - Motor windings • Case - Electromagnetic brake windings	
Dielectric strength	Sufficient to withstand the following for 1 minute: • AC power input type • Case - Motor windings 1.5 kVAC 50/60 Hz • Case - Electromagnetic brake windings 1.5 kVAC 50/60 Hz • DC power input type • Case - Motor windings 1.0 kVAC 50/60 Hz *3 • Case - Electromagnetic brake windings 1.0 kVAC 50/60 Hz *3	

*1 When the cable outlet direction is in the horizontal direction with respect to the motor.

*2 Based on our measurement conditions.

*3 0.5 kVAC 50/60 Hz for **AZM14, AZM15, AZM24**, and **AZM26**

Regulations and standards

■ UL Standards

Check the "APPENDIX UL Standards for **AZ Series**" for recognition information about UL Standards.

■ CE Marking

Motors of AC power input type are affixed the CE Marking under the Low Voltage Directive.

● Low Voltage Directive

- This product cannot be used in IT power distribution systems.
- Install the product within the enclosure in order to avoid contact with hands.
- When a product can be touched with hands, be sure to ground. Make sure to ground the Protective Earth Terminals of the motor and driver.
- To protect against electric shock using an earth leakage breaker (RCD), connect a type B earth leakage breaker to the primary side of the driver.
- When using a circuit breaker (MCCB), use a unit conforming to the EN or IEC standard.
- Isolate the motor cable, power-supply cable and other drive cables from the signal cables by means of double insulation.
- The temperature of the driver's heat sink may exceed 90 °C (194 °F) depending on the driving conditions. Accordingly, take heed of the following items:
 - Do not touch the driver.
 - Do not use the driver near flammable objects.
 - Always conduct a trial operation to check the driver temperature.

● Applicable Standards

EN 60034-1, EN 60034-5, EN 60664-1

● Installation condition (EN Standards)

- To be incorporated in equipment
- Overvoltage category: II
- Pollution degree: 3
- Degree of protection: IP66
- Protection against electric shock: Class I

● EMC Directive

The **AZ Series** motor conforms to the EMC Directive in a state where the motor is connected with the driver. For details, refer to the operating manual of the driver.

■ RoHS Directive

The products do not contain the substances exceeding the restriction values of RoHS Directive (2011/65/EU).

- Unauthorized reproduction or copying of all or part of this manual is prohibited.
- Oriental Motor shall not be liable whatsoever for any problems relating to industrial property rights arising from use of any information, circuit, equipment or device provided or referenced in this manual.
- Characteristics, specifications and dimensions are subject to change without notice.
- While we make every effort to offer accurate information in the manual, we welcome your input. Should you find unclear descriptions, errors or omissions, please contact your nearest Oriental Motor sales office.
- **Orientalmotor**, **QSTEP**, and ABZO sensor are registered trademarks or trademarks of Oriental Motor Co., Ltd., in Japan and other countries.

© Copyright ORIENTAL MOTOR CO., LTD. 2013

Published in November 2020

- Please contact your nearest Oriental Motor office for further information.

ORIENTAL MOTOR U.S.A. CORP.
 Technical Support Tel:800-468-3982
 8:30am EST to 5:00pm PST (M-F)
www.orientalmotor.com

ORIENTAL MOTOR (EUROPA) GmbH
 Schiessstraße 44, 40549 Düsseldorf, Germany
 Technical Support Tel:00 800/22 55 66 22
www.orientalmotor.de

ORIENTAL MOTOR (UK) LTD.
 Tel:+44-1256347090
www.oriental-motor.co.uk

ORIENTAL MOTOR (FRANCE) SARL
 Tel:+33-1 47 86 97 50
www.orientalmotor.fr

ORIENTAL MOTOR ITALIA s.r.l.
 Tel:+39-02-93906347
www.orientalmotor.it

ORIENTAL MOTOR CO., LTD.
 4-8-1Higashiueno,Taito-ku,Tokyo 110-8536
 Japan
 Tel:+81-3-6744-0361
www.orientalmotor.co.jp

ORIENTAL MOTOR ASIA PACIFIC PTE. LTD.
 Singapore
 Tel:1800-842-0280
www.orientalmotor.com.sg

ORIENTAL MOTOR (MALAYSIA) SDN. BHD.
 Tel:1800-806-161
www.orientalmotor.com.my

ORIENTAL MOTOR (THAILAND) CO., LTD.
 Tel:1800-888-881
www.orientalmotor.co.th

ORIENTAL MOTOR (INDIA) PVT. LTD.
 Tel:1800-120-1995 (For English)
 1800-121-4149 (For Hindi)
www.orientalmotor.co.in

TAIWAN ORIENTAL MOTOR CO., LTD.
 Tel:0800-060708
www.orientalmotor.com.tw

SHANGHAI ORIENTAL MOTOR CO., LTD.
 Tel:400-820-6516
www.orientalmotor.com.cn

INA ORIENTAL MOTOR CO., LTD.
 Korea
 Tel:080-777-2042
www.inaom.co.kr