



Tuning-free AC servo motor

NX Series

USER MANUAL



Before use

Installation and
connection

Position control mode

Speed control mode

Torque control mode

Tension control mode

Operation using the
OPX-2A

Monitor function

Inspection,
troubleshooting and
remedial actions

Cables and accessories

References

Thank you for purchasing an Oriental Motor product.

This Manual describes product handling procedures and safety precautions.

- Please read it thoroughly to ensure safe operation.
- Always keep the manual where it is readily available.

1 Before use

1	Introduction	8
2	Overview of the product.....	9
3	System configuration	10
4	Safety precautions	11
5	Precautions for use	15
6	General specifications	18
7	Regulations and standards.....	20
7-1	UL Standards and CSA Standards	20
7-2	EU Directives.....	20
7-3	RoHS Directive	21
8	Preparation.....	22
8-1	Checking the product	22
8-2	How to identify the product model	23
8-3	Combinations of motors and drivers.....	24
8-4	Input/output power ratings.....	26
8-5	Names and functions of parts.....	28

2 Installation and connection

1	Installation.....	34
1-1	Installation location	34
1-2	Installing the motor	34
1-3	Installing a load	36
1-4	Permissible radial load and permissible axial load	37
1-5	Installing the driver	38
1-6	Installing the regeneration resistor.....	40
1-7	Installing and wiring in compliance with EMC Directive.....	41
2	Connection	44
2-1	Connection method for connectors	44
2-2	Connecting the motor	45
2-3	Connecting the I/O signals.....	46
2-4	Connecting the analog I/O signals.....	56
2-5	Connecting the power supply	58
2-6	Grounding the driver.....	59
2-7	Connecting the 24 VDC power supply input, regeneration resistor and electromagnetic brake.....	59
2-8	Connecting the battery	62
2-9	Connecting the data setter	62

3 Position control mode

1	Guidance.....	64
2	List of setting items.....	66
2-1	Operation data.....	66
2-2	Application parameters.....	66
2-3	System parameters.....	68
3	Positioning operation based on pulse input	69
4	Torque limit	76
5	Absolute system	79
5-1	Coordinate control range.....	79
5-2	Loss of absolute position	79
5-3	Resetting the absolute position loss alarm	80
6	Current position output.....	82
6-1	Information that can be read.....	82
6-2	I/O signals used	83
7	Gain tuning.....	84
7-1	Selecting the tuning mode	84
7-2	Gain tuning mode	84
7-3	Gains that can be set with automatic tuning/semi-auto tuning.....	86
7-4	Method of gain tuning using the MEXE02	87
8	Command filter	89
9	Damping control	90
9-1	Analog setting.....	91
9-2	Digital setting.....	91

4 Speed control mode

1	Guidance.....	94
2	List of setting items.....	96
2-1	Operation data.....	96
2-2	Application parameters.....	96
2-3	System parameters.....	98
3	Speed control operation	99
4	Torque limit	108
5	Gain tuning.....	111
5-1	Selecting the tuning mode	111
5-2	Gain tuning mode	111
5-3	Gains that can be set with automatic tuning/semi-auto tuning.....	113
5-4	Method of gain tuning using the MEXE02	114

5 Torque control mode

1	Guidance.....	118
2	List of setting items.....	120
2-1	Operation data.....	120
2-2	Application parameters.....	120
2-3	System parameters.....	121
3	Torque control operation.....	122
4	Speed limit.....	129
4-1	Using the internal potentiometer VR2.....	129
4-2	Using an external potentiometer or external DC voltage.....	130
4-3	Digital setting.....	131

6 Tension control mode

1	Guidance.....	134
2	List of setting items.....	136
2-1	Operation data.....	136
2-2	Application parameters.....	136
2-3	System parameters.....	138
3	Selecting the operation mode.....	139
4	Tension controlled operation (simple mode).....	140
5	Tension control operation (high function mode I, high function mode II).....	145
6	Timing chart.....	152
7	Speed limit.....	156
7-1	Using the internal potentiometer VR2.....	157
7-2	Using an external potentiometer or external DC voltage.....	157
7-3	Digital setting.....	158

7 Operation using the OPX-2A

1	Overview of the OPX-2A.....	160
1-1	Names and functions of parts.....	161
1-2	How to read the display.....	161
1-3	OPX-2A error display.....	162
2	Screen transitions in the position control mode.....	163
3	Screen transitions in the speed control mode.....	168
4	Screen transitions in the torque control mode.....	173
5	Screen transitions in the tension control mode.....	178
6	Monitor mode.....	184
6-1	Overview of the monitor mode.....	184
6-2	Monitor item.....	184
6-3	Descriptions of I/O monitor.....	185

7	Data mode	187
7-1	Data selection method	187
7-2	Setting item of operation data	187
8	Test mode	189
8-1	Overview of the test mode.....	189
8-2	I/O test	189
8-3	JOG operation	191
8-4	Preset the current position.....	191
8-5	Preset the Z-phase.....	191
8-6	Offset the analog speed input	191
8-7	Offset the analog torque input.....	192
9	Copy mode	193
9-1	Overview of the copy mode	193
9-2	Error of the copy mode.....	194

8 Monitor function

1	Encoder output	196
1-1	Resolution of encoder output.....	196
2	Analog monitor	197
2-1	Analog speed monitor	197
2-2	Analog torque monitor.....	198

9 Inspection, troubleshooting and remedial actions

1	Inspection	200
2	Alarms and warnings	201
2-1	Alarms	201
2-2	Warnings	207
2-3	Timing charts.....	208
3	Troubleshooting and remedial actions	210

10 Cables and accessories

1	Cables	214
1-1	Connection cable sets/extension cable sets.....	214
1-2	Communication cable for the support software.....	219
1-3	Driver cables	219
2	Accessories	220
2-1	Wiring support tools.....	220
2-2	Setting tool	220
2-3	Other accessory.....	220

11 References

1	Timing charts	222
2	Speed - Torque Characteristics	236
2-1	Standard type.....	236
2-2	PS geared type	237
2-3	PJ geared type.....	239
3	Function/parameter list (position control mode)	242
4	Function/parameter list (speed control mode)	250
5	Function/parameter list (torque control mode)	258
6	Function/parameter list (tension control mode).....	262
7	Alarm list	268
8	Warnings list.....	272



1 Before use

This part explains the composition of the operating manuals, the product overview, specifications and safety standards as well as the name and function of each part and others.

◆ Table of contents

1	Introduction	8
2	Overview of the product.....	9
3	System configuration.....	10
4	Safety precautions	11
5	Precautions for use.....	15
6	General specifications	18
7	Regulations and standards.....	20
	7-1 UL Standards and CSA Standards	20
	7-2 EU Directives.....	20
	7-3 RoHS Directive	21
8	Preparation	22
	8-1 Checking the product	22
	8-2 How to identify the product model	23
	8-3 Combinations of motors and drivers.....	24
	8-4 Input/output power ratings.....	26
	8-5 Names and functions of parts.....	28

1 Introduction

■ Before use

Only qualified personnel of electrical and mechanical engineering should work with the product.

Use the product correctly after thoroughly reading the section "4 Safety precautions" on p.11. In addition, be sure to observe the contents described in warning, caution, and note in this manual.

The product described in this manual is designed and manufactured to be incorporated in general industrial equipment. Oriental Motor Co., Ltd. is not responsible for any compensation for damage caused through failure to observe this warning.

■ Related operating manuals

For operating manuals not included with the product, contact your nearest Oriental Motor sales office or download from Oriental Motor Website Download Page.

Operating manual name	Included or not included with product
NX Series OPERATING MANUAL Motor Edition	Included
NX Series OPERATING MANUAL Drive Edition	Included
NX Series USER MANUAL (this document)	Not included

2 Overview of the product

The tuning-free AC servo motor and driver package **NX** Series is a product consisting of a high-performance motor equipped with 20-bit absolute encoder, and a driver supporting four control modes based on position, speed, torque, and tension.

When used with our support software **MEXE02** or data setter **OPX-2A**, you can set parameters and data using the switches on the driver and also access extended functions.

■ Main features

● Stable operation without tuning

- The automatic tuning function ensures stable operation of the equipment regardless of its mechanism. If the present response is insufficient, all you need is to adjust the mechanical rigidity setting switch and the motor will operate with higher response.
- With an internal potentiometer, setting of damping control frequency is easy. Even if the motor is assembled into a machine of low rigidity, you can suppress residual vibration during positioning, in order to improve compliance.
- Automatic tuning supports an adjustment range of up to 50 times the rotor inertial moment, while manual tuning supports an adjustment range of up to 100 times.

● Selection from four control modes

You can set one of four control modes using the control mode setting switches on the driver.

- Position control mode Positioning operation is performed based on input pulses.
- Speed control mode The operating speed is controlled via I/O signals.
- Torque control mode The motor is operated at a constant torque.
- Tension control mode The generated torque and speed of the motor are adjusted to maintain a constant tension during winding and unwinding operations.

● Separate main power supply and control power supply

A separate 24 VDC power supply is connected to supply control power, independently of the main power supply. This way, the motor position can be detected and contents of alarms can be checked while the 24 VDC power is supplied, even when the main power is cut off.

● Supporting sink output and source output

The driver supports both the current sink output circuit and the current source output circuit. (Line driver output is not supported).

● Automatically controlled electromagnetic brake

The driver automatically controls the electromagnetic brake, all you need is to connect a 24 VDC power supply and the electromagnetic brake will operate. The timings of control signal inputs or the troublesome ladder logic design can be saved.

● Alarm and warning functions

The driver provides alarms that are designed to protect the driver from overheating, poor connection, misoperation, etc. (protective functions), as well as warnings that are output before the corresponding alarms generate (warning functions).

● Absolute system

Connect our battery **BAT01A** and use the driver in the position control mode, and your **NX** Series will effectively comprise an absolute system.

■ Extended functions

When used with the **MEXE02** or the **OPX-2A**, the **NX** Series driver lets you set desired parameters, operation mode, resolution and other items according to the needs of your equipment.

3 System configuration

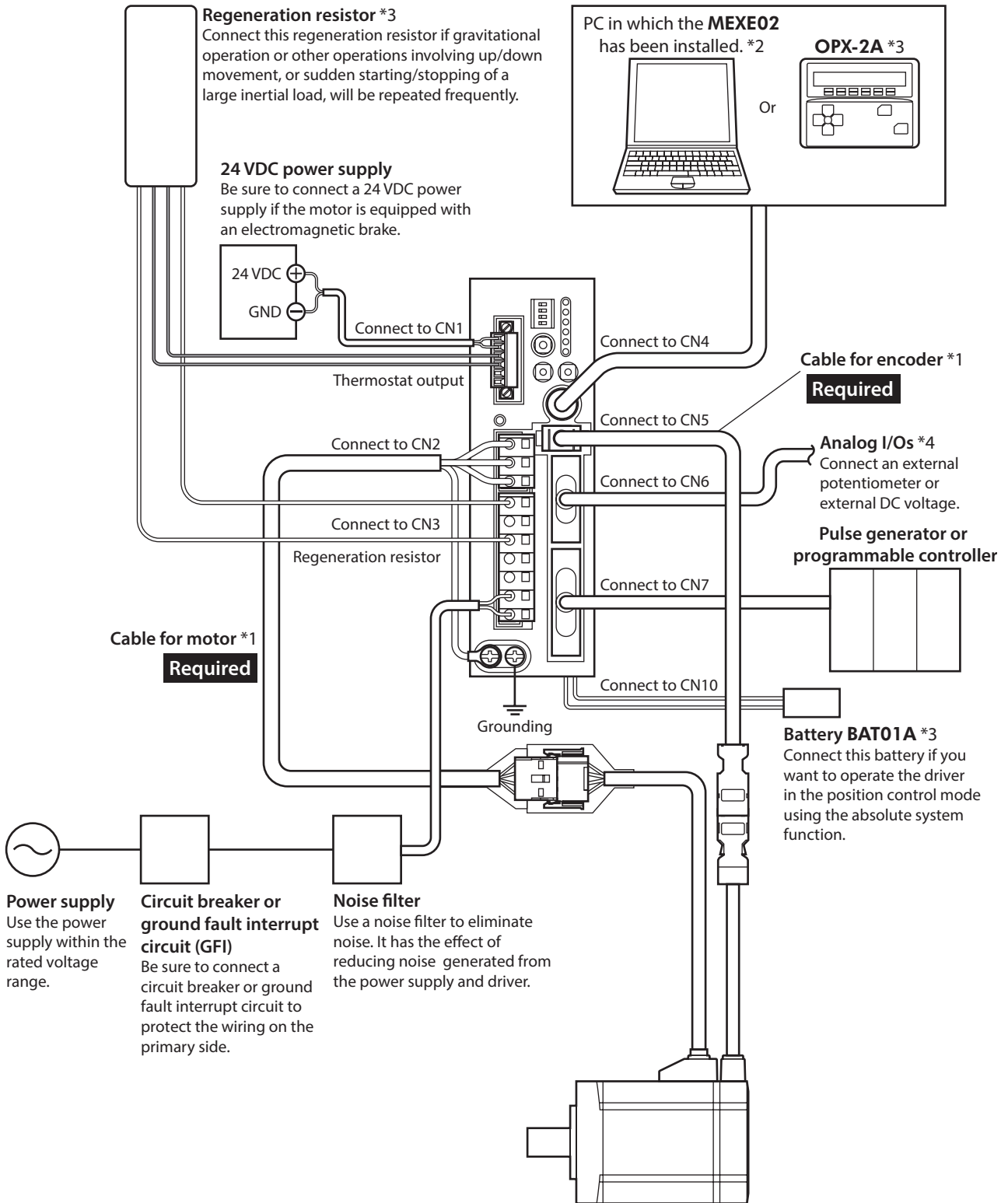

1 Before use



*1 These cables are provided as our products. These cables are included with the product or sold separately.
 *2 The PC must be supplied by the customer. Use our communication cable for the support software **CC05IF-USB** when connecting the PC and driver.
 *3 These products are provided as our accessories.
 *4 A set of the CN6 connector and variable resistors is provided as our products.



4 Safety precautions

The precautions described below are intended to ensure the safe and correct use of the product, and to prevent the customer and others from exposure to the risk of injury. Use the product only after carefully reading and fully understanding these instructions.

 WARNING	Handling the product without observing the instructions that accompany a “WARNING” symbol may result in serious injury or death.
 CAUTION	Handling the product without observing the instructions that accompany a “CAUTION” symbol may result in injury or property damage.
 Note	The items under this heading contain important handling instructions that the user should observe to ensure the safe use of the product.

WARNING

General

- Do not use the product in explosive or corrosive environments, in the presence of flammable gases, in places subjected to splashing water, or near combustibles. Doing so may result in fire, electric shock, or injury.
- Assign qualified personnel to the task of installing, wiring, operating/controlling, inspecting, and troubleshooting the product. Failure to do so may result in fire, electric shock, or injury.
- Do not transport, install, connect or inspect the product while the power is supplied. Always turn the power off before carrying out these operations. Failure to do so may result in electric shock.
- Take measures to keep the moving part in position if the product is used in vertical operations such as elevating equipment. In the position control mode, the motor will lose its holding torque when the power is turned off. In all other modes, the holding torque will be lost when the motor stops. Loss of holding torque may cause the moving part to drop, resulting in injury or damage to the equipment.
- The terminals on the driver’s front panel marked with   symbol indicate the presence of high voltage. Do not touch these terminals while the power is on to avoid the risk of fire or electric shock.
- When an alarm is generated in the driver (any of the driver’s protective functions is triggered), take measures to hold the moving part in a specific position since the motor stops and loses its holding torque. Failure to do so may result in injury or damage to equipment.
- When an alarm is generated in the driver (any of the driver’s protective functions is triggered), remove the cause before clearing the alarm (protective function). Continuing the operation without removing the cause of the problem may cause malfunction of the motor and driver, leading to injury or damage to equipment.

Installation

- The motor and driver are Class I equipment. When installing the motor and driver, install them inside an enclosure so that they are out of the direct reach of users. Be sure to ground if users can touch them. Failure to do so may result in electric shock.
- Install the motor and the driver inside an enclosure. Failure to do so may result in electric shock or injury.

Connection

- Always keep the power supply voltage of the driver within the specified range. Failure to do so may result in fire or electric shock.
- Connect the cables securely according to the wiring diagram. Failure to do so may result in fire or electric shock.
- Do not forcibly bend, pull, or pinch the cable. Doing so may result in fire or electric shock.

Operation

- Turn off the driver power supply in the event of a power failure. Otherwise, the motor may suddenly start when the power is restored, causing injury or damage to equipment.
- Do not remove the motor excitation during operation. Doing so may cause the motor to stop and lose the holding force, resulting in injury or damage to equipment.

Maintenance and inspection

- Do not touch the connection terminal of the driver while the power is supplied. Turn off the power to check the CHARGE LED being turned off before starting connection or inspection. Failure to do so may result in electric shock.

Repair, disassembly and modification

- Do not disassemble or modify the motor and driver. This may cause electric shock or injury. Refer all such internal inspections and repairs to the Oriental Motor sales office from which you purchased the product.



General

- Do not use the motor and the driver beyond its specifications. Doing so may result in electric shock, injury, or damage to equipment.
- Keep your fingers and objects out of the openings in the motor and the driver. Failure to do so may result in fire, electric shock, or injury.
- Do not touch the motor and driver during operation or immediately after stopping. The surface is hot, and this may cause a skin burn(s).

Transportation

- Do not hold the motor output shaft or motor cable. This may cause injury.

Installation

- Provide a cover over the rotating parts (output shaft) of the motor to prevent injury.
- Do not leave anything around the motor and the driver that would obstruct ventilation. Doing so may result in damage to equipment.

Connection

- The data edit connector (CN4) and the analog I/O connector (CN6) on the driver are not electrically insulated. When grounding the positive terminal of the power supply, do not connect any equipment (PC, etc.) whose negative terminal is grounded. Doing so may cause the driver and these equipment to short, damaging both.

Operation

- Use a motor and driver only in the specified combination. An incorrect combination may cause a fire.
- Provide an emergency-stop device or emergency-stop circuit external to the equipment so that the entire equipment will operate safely in the event of a system failure or malfunction. Failure to do so may result in injury.
- Before supplying power to the driver, turn all input signals to the driver to OFF. Otherwise, the motor may suddenly start when the power is turned on, leading to injury or damage to equipment.
- Do not touch the rotating parts (output shaft) of the motor during operation. This may cause injury.
- When moving the moving part manually, put the motor into a non-excitation state. Continuing the work while the motor is in an excitation state may result in injury.
- Use a 24 VDC power supply that has been given reinforced insulation between the primary side and secondary side. Failure to do so may cause electric shock.
- Immediately when a problem occurred, stop operation and turn off the driver power supply. Failure to do so may result in fire, electric shock or injury.
- The motor surface temperature may exceed 70 °C (158 °F), even under normal operating conditions. If the operator is allowed to approach the motor in operation, affix a warning label shown in the figure on a conspicuous position. Failure to do so may result in a skin burn(s).
- To prevent electric shock, use only an insulated screwdriver to adjust the driver's switches.



Warning label

Maintenance and inspection

- Do not touch the terminals while conducting the insulation resistance measurement or dielectric strength test. Doing so may cause electric shock.

Disposal

- Dispose the product correctly in accordance with laws and regulations, or instructions of local governments.

■ Precautions when using lithium thionyl chloride batteries

The built-in battery is a lithium thionyl chloride battery with hermetically sealed construction by glass sealing and laser welding. Always observe the following items when using the battery. If the battery is improperly used, heat, explosion, fire, etc. may happen. Doing so may result in damage to equipment.

WARNING

Do not recharge

- Never try to recharge the battery. If it is recharged, the electrolyte of the battery heats, gas is generated, the pressure in the battery may increase, and the battery may leak, heat, explode or catch on fire.
- Only use these battery for the specified use. Contact failure or dissatisfaction with specification and performance may occur if the terminal construction or the like does not fit the apparatus. The battery may leak, heat, explode or catch on fire.
- Do not incinerate, heat, disassemble or remodel the battery. The glass seal part or the vent part (the vent for gas to escape) may be damaged, and the battery may leak, heat, explode or catch on fire.
- If the liquid of the battery touches the eyes, the eyes may be injured. Do not rub the eyes, but flush the eyes amply with clean water such as city water and then receive medical treatment immediately.
- If the liquid of the battery gets into the mouth, rinse out the mouth and consult a doctor immediately.
- Do not short the + – terminals of the battery with a wire and do not carry or keep a metallic necklace, hairpin, etc. together with batteries. The battery may be short-circuited, causing over-current and may leak, heat, explode or catch on fire.
- If leakage or a strong odor comes from the battery, the leaked electrolyte may corrode any metal parts; so, dispose of the battery immediately.
- Do not peel off or damage the outer label (heat-shrinkable tube) of the battery. The battery may be short-circuited and may leak, heat, explode or catch on fire.
- Do not expose battery to strong impact by dropping or throwing the battery. The battery may leak, heat, explode or catch on fire.
- Do not deform the battery. The glass seal part or the vent part (the vent for gas to escape), etc, may be damaged and the battery may leak, heat, explode or catch on fire.
- At storage or disposal of the battery, insulate the terminal part with tape or the like. If the battery is mixed with other battery or metallic object, the battery may be short-circuited and may heat, explode or catch on fire.

CAUTION

- Do not use or keep the battery in places exposed to strong direct sunlight or in cars under hot sun, etc. The battery may leak, heat or explode.
- Keep the battery away from water. The battery may heat.
- At the storage of battery, avoid direct sunlight, high temperature and high humidity places. The battery may leak, heat or explode. In addition, the performance and the life of the battery may decrease.
- This battery is allowed to be disposed as general incombustible refuse. However, if rules for battery disposal exist, such as regulations of local government, dispose of the battery in accordance with the rules.
- Do not give ultrasonic vibration to the battery. By ultrasonic vibration, the contents of battery will be finely powdered, which may cause internal short-circuit resulting in leakage, heat or explosion of the battery.

■ Precautions against transport and storage

Store the battery in a place that satisfies the following conditions: Storage of the battery at high temperature or high humidity may decrease the performance or cause leakage.

- Avoid high temperature and high humidity
- Well ventilated dry place where the temperature is not so high
- A place having a normal temperature [+5 to +35 °C (+41 to +95 °F)], little temperature fluctuation
- A relative humidity of 70 % or less
- Avoid direct sunlight
- Keep away from rain water

Avoid rough handling during transport. Rough handling may cause dents or deformation, which can bring a decrease of performance or leakage. Moreover, the battery compartment may be damaged, causing the battery to be deformed; if the + – terminals are short-circuited the battery may be damaged by heating, and moreover leakage, explosion, fire, etc. may happen.

As for the distribution, such as transport, display and others, observe strictly the first-in, first-out method and pay attention to avoid long-term stock. The battery has a long storage property at normal temperature and humidity conditions [normal temperature: +5 to +35 °C (+41 to +95 °F), relative humidity: 70 % or less]; however since the long-term stock may deteriorate their performance, observe strictly the appropriate volume of inventories and the first-in, first-out method.

5 Precautions for use

This chapter covers restrictions and requirements the user should consider when using the product.

- **Be sure to use our cable to connect the motor and driver.**

Be sure to purchase our cable separately in the following cases. Check the cable models on p.214

- If a flexible cable is to be used.
- If a cable of 3 m (9.8 ft.) or longer is to be used.

- **When conducting the insulation resistance measurement or the dielectric strength test, be sure to separate the connection between the motor and the driver.**

Conducting the insulation resistance measurement or dielectric strength test with the motor and driver connected may result in damage to the product.

- **Do not apply a radial load and axial load in excess of the specified permissible limit.**

Continuing to operate the motor under an excessive radial load or axial load may damage the bearings (ball bearings) of the motor. Be sure to operate the motor within the specified permissible limit of radial load and axial load.

- **Do not use the electromagnetic brake for braking or as a safety brake.**

Do not use the electromagnetic brake as a means to decelerate and stop the motor. The brake hub of the electromagnetic brake will wear significantly and the braking force will drop. Since the power off activated type electromagnetic brake is equipped, it helps maintain the position of the load when the power is cut off, but this brake cannot securely hold the load in place. Accordingly, do not use the electromagnetic brake as a safety brake. To use the electromagnetic brake to hold the load in place, do so after the motor has stopped.

- **Preventing leakage current**

Stray capacitance exists between the driver's current-carrying line and other current-carrying lines, the earth and the motor, respectively. A high-frequency current may leak out through such capacitance, having a detrimental effect on the surrounding equipment. The actual leakage current depends on the driver's switching frequency, the length of wiring between the driver and motor, and so on. When providing a leakage current breaker, use the following products, for example, which have high-frequency signal protection:
Mitsubishi Electric Corporation: NV Series

- **Noise elimination measures**

Refer to "1-7 Installing and wiring in compliance with EMC Directive" on p.41 for noise elimination measures.

- **About grease of geared motor**

On rare occasions, a small amount of grease may ooze out from the geared motor. If there is concern over possible environmental damage resulting from the leakage of grease, check for grease stains during regular inspections. Alternatively, install an oil pan or other device to prevent leakage from causing further damage. Oil leakage may lead to problems in the customer's equipment or products.

- **Do not apply impact to the encoder.**

If the encoder receives strong impact, the encoder may be damaged or the motor may malfunction.

- **Saving data to the non-volatile memory**

Do not turn off the main power supply or 24 VDC power supply while writing the data to the non-volatile memory, and also do not turn off for 5 seconds after the completion of writing the data. Doing so may abort writing the data and cause an EEPROM error alarm to generate. The non-volatile memory can be rewritten approximately 100,000 times.

- **Motor excitation at power ON**

When the driver has been set to lock the servo after the motor stops in the position control mode or speed control mode: Turning on the power supply will not excite the motor. To excite the motor, you must turn the S-ON input ON. You can set the motor to be excited automatically after the power has been turned on, by changing the applicable driver parameter using the **MEXE02** or the **OPX-2A**.

- **If vertical drive (gravitational operation) such as elevator applications is performed or if sudden start-stop operation of a large inertial load is repeated frequently, connect our regeneration resistor.**

The factory setting is to use the internal regeneration resistor. Note, however, that the internal regeneration resistor does not support continuous regenerative operation, gravitational operation or other operations involving up/down movements, or frequent repeating of sudden starting/stopping of a large inertial load. If any of these operations must be performed, use our regeneration resistor. Check the model names on p.220

- **Note on connecting a power supply whose positive terminal is grounded**

The data edit connector (CN4) and the analog I/O connector (CN6) on the driver are not electrically insulated. When grounding the positive terminal of the power supply, do not connect any equipment (PC, etc.) whose negative terminal is grounded. Doing so may cause the driver and these equipment to short, damaging both. Use the **OPX-2A** to set data, etc.

- **Rotation direction of the motor output shaft**

The motor output shaft rotates as shown in the figure for the parameters of the factory setting. The output shaft of geared motors also rotates in the same direction as that of motors.

- 2-pulse input mode: When the CW input is being ON.
1-pulse input mode: When the DIR input is being ON.
- 2-pulse input mode: When the CCW input is being ON.
1-pulse input mode: When the DIR input is being OFF.

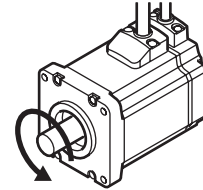
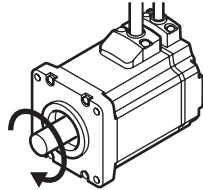

- **Make sure not to hit or apply a strong impact on the motor output shaft or the encoder.**

Applying a strong impact on the motor output shaft or the encoder may cause encoder damage or motor malfunction. The warning label shown in the right is attached on the motor.

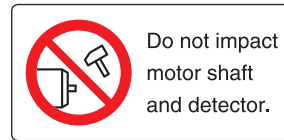

Warning label

- **Make sure to provide measures so that the key is not flown off when operating the motor with key in a state where a load is not installed.**

Flying off the key may result in injury or damage to equipment.

- **Notes when the connection cable is used**

Note the following points when our cable is used.

- **When inserting the connector**

Hold the connector main body, and insert it in straight securely. Inserting the connector in an inclined state may result in damage to terminals or a connection failure.

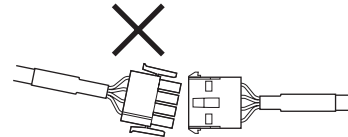

- **When pulling out the connector**

Pull out the connector in straight while releasing the lock part of the connector. Pulling out the connector with holding the cable may result in damage to the connector.

- **Bending radius of cable**

Use the cable in a state where the bending radius of the cable is more than six times of the cable diameter. Do not bend the lead wires part or fix it with a clamp. Doing so may cause damage to the connector.

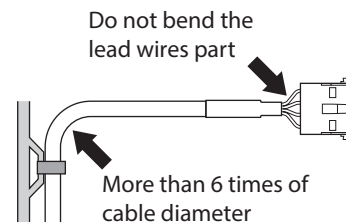

- **How to fix the cable**

Fix the cable at the positions near the connector so that no stress is applied on the connector part.
Take measures so that no stress is applied on the connector by using wide clamps or by fixing at two places.

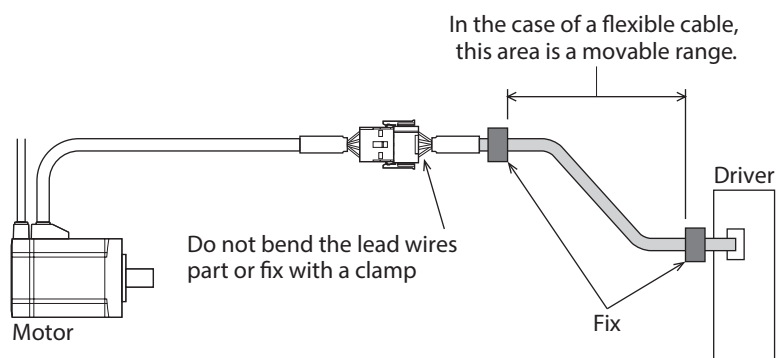

6 General specifications

1 Before use

Motor specifications

Degree of protection		IP65 *
Operation environment	Ambient temperature	0 to +40 °C (+32 to +104 °F) (non-freezing)
	Humidity	85 % or less (non-condensing)
	Altitude	Up to 1,000 m (3,300 ft.) above sea level
	Surrounding atmosphere	No corrosive gas, liquids, or oil (oil droplets)
Storage environment	Ambient temperature	-20 to +60 °C (-4 to +140 °F) (non-freezing)
	Humidity	85 % or less (non-condensing)
	Altitude	Up to 3,000 m (10,000 ft.) above sea level
	Surrounding atmosphere	No corrosive gas, liquids, or oil (oil droplets)
Shipping environment	Ambient temperature	-20 to +60 °C (-4 to +140 °F) (non-freezing)
	Humidity	85 % or less (non-condensing)
	Altitude	Up to 3,000 m (10,000 ft.) above sea level
	Surrounding atmosphere	No corrosive gas, liquids, or oil (oil droplets)

* With the standard motors, excluding the through part of the shaft and connectors. With the geared motors, excluding the connectors.

Driver specifications

Operation environment	Degree of protection	IP20
	Ambient temperature	0 to +50 °C (+32 to +122 °F) (non-freezing)
	Humidity	85 % or less (non-condensing)
	Altitude	Up to 1,000 m (3,300 ft.) above sea level
	Surrounding atmosphere	No corrosive gas, dust, water or oil
Storage environment	Ambient temperature	-25 to +70 °C (-13 to +158 °F) (non-freezing)
	Humidity	85 % or less (non-condensing)
	Altitude	Up to 3,000 m (10,000 ft.) above sea level
	Surrounding atmosphere	No corrosive gas, dust, water or oil
Shipping environment	Ambient temperature	-25 to +70 °C (-13 to +158 °F) (non-freezing)
	Humidity	85 % or less (non-condensing)
	Altitude	Up to 3,000 m (10,000 ft.) above sea level
	Surrounding atmosphere	No corrosive gas, dust, water or oil



- Maximum Surrounding Air Temperature +40 to +50 °C (+104 to +122 °F). When the surrounding air temperature exceeds +40 °C (+104 °F), continuous motor output power shall be within the derating curve. (NXD20-A and NXD20-C)
- Maximum Surrounding Air Temperature +50 °C (+122 °F). When the surrounding air temperature exceeds +45 °C (+113 °F), continuous motor output power shall be within the derating curve. (NXD75-S)

■ Battery specifications

Battery type	Lithium thionyl chloride batteries
Life	Approximately 4 years *
Data retention period	2 years *
Ambient temperature	0 to +50 °C (+32 to +122 °F) (non-freezing)
Ambient humidity	85 % or below (non-condensing)
Storage/Transporting temperature	+5 to +35 °C (+41 to +95 °F) (non-freezing)
Storage/Transporting humidity	70 % or below (non-condensing)

* At an ambient temperature of 20 °C (68 °F)

■ Derating curve for continuous motor output

● Rated output: 100 W

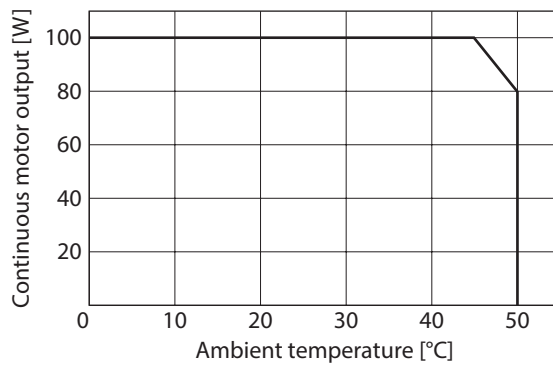

● Rated output: 200 W

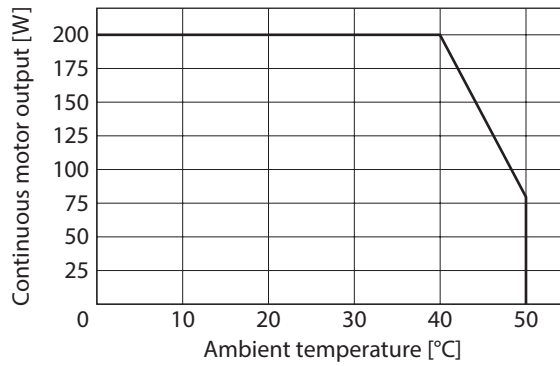

● Rated output: 750 W

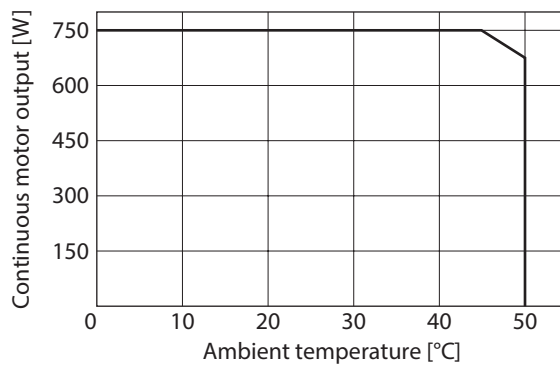

1 Before use

7 Regulations and standards

7-1 UL Standards and CSA Standards

This product is recognized by UL under the UL and CSA Standards.

■ Applicable standards

	Applicable standards	Certification Body	File No.
Motor	UL 1004-1, UL 1004-6 CSA C22.2 No.100	UL	E336472
Driver	UL 61800-5-1 CSA C22.2 No.274	UL	E171462

■ Warning for UL Marking

- For UL Standard (UL 61800-5-1), the product is recognized for the condition of Maximum Surrounding Air Temperature 50 °C (122 °F).
- Suitable For Use On A Circuit Capable Of Delivering Not More Than 5,000 A rms Symmetrical Amperes, 120 Volts or 240 Volts Maximum.
- Integral solid state short circuit protection does not provide branch circuit protection. Branch circuit protection must be provided in accordance with the National Electric Code and any additional local codes.
- Is used UL Listed Inverse Time Circuit Breaker rated 240 Vac, 15 A.
- Solid State motor overload protection is provided in each model. (NXD20-A/NXD20-C)
- Solid State motor overload protection reacts at 150 % FLA or less. (NXD75-S)
- Drives have no provision for motor over temperature protection. Motor over temperature protection is required at end application.

7-2 EU Directives

■ CE Marking

This product is affixed the CE Marking under the Low Voltage Directive and EMC Directive.

● Low Voltage Directive

The motors are certified by TÜV Rheinland under the EN 60034-1 and EN 61800-5-1. (NXM620, NXM810, NXM820, NXM920, NXD20-A and NXD20-C only)

	Motor	Driver
Applicable standards	EN 60034-1, EN 60034-5, EN 60664-1	EN 50178, EN 61800-5-1
Installation conditions	To be incorporated in equipment. Overvoltage category: II Pollution degree: 3 Protection against electric shock: Class I	To be incorporated in equipment. Overvoltage category: II Pollution degree: 2 Protection against electric shock: Class I

- This product cannot be used in IT power distribution systems.
- Install the product within the enclosure in order to avoid contact with hands.
- Be sure to maintain a protective ground in case hands should make contact with the product.
Be sure to connect the Protective Earth wire of the cable for motor to the Protective Earth Terminal on the driver, and ground the driver's Protective Earth Terminal.
- To protect against electric shock using an earth leakage breaker (RCD), connect a type B earth leakage breaker to the primary side of the driver.
- When using a circuit breaker (MCCB), use a product conforming to EN Standards or IEC Standards.
- Isolate the motor cable, power-supply cable and other drive cables from the signal cables (CN1, CN4 to CN7) by means of double insulation.

- **EMC Directive**

This product is conducted EMC testing under the conditions specified in “Example of installation and wiring” on p.42.

The conformance of your mechanical equipment with the EMC Directive will vary depending on such factors as the configuration, wiring, and layout for other control system devices and electrical parts used with this product. It therefore must be verified through conducting EMC measures in a state where all parts including this product have been installed in the equipment.

Applicable standards

EMI	EN 55011 group 1 class A, EN 61000-6-4, EN 61800-3
EMS	EN 61000-6-2, EN 61800-3

CAUTION

This equipment is not intended for use in residential environments nor for use on a low-voltage public network supplied in residential premises, and it may not provide adequate protection to radio reception interference in such environments.

7-3 RoHS Directive

The products do not contain the substances exceeding the restriction values of RoHS Directive (2011/65/EU).

8 Preparation

This chapter explains the items you should check, as well as the name and function of each part.

8-1 Checking the product

Verify that the items listed below are included. Report any missing or damaged items to the Oriental Motor sales office from which you purchased the product.

Verify the model name of the purchased motor and driver package against the model name shown on the package label.

Check the model name of the motor and driver against the model name shown on the nameplate.

The motor and driver package names and corresponding motor/driver combinations are listed on p.24.

- Motor 1 unit
- Driver 1 unit
- CN1 connector (6 pins)..... 1 pc.
- CN2 connector (3 pins)..... 1 pc.
- CN3 connector (7 pins)..... 1 pc.
- CN7 connector (36 pins) 1 pc.
- Connector wiring lever (for CN2, CN3) 1 pc.
- Cable for motor 1 pc. (included with motor and driver packages)
- Cable for encoder 1 pc. (included with motor and driver packages)
- Cable for electromagnetic brake 1 pc. (included with electromagnetic brake motor and driver packages)
- Parallel key 1 pc. (included with geared motors)
- OPERATING MANUAL Motor Edition 1 copy
- OPERATING MANUAL Driver Edition..... 1 copy

Included connector model

The CN2 connector and the CN3 connector are made by either of two manufacturers, WAGO Corporation and Molex Incorporated.

The CN7 connector is made by either of two manufacturers, 3M Company and Molex Incorporated.

About each connector (CN2, CN3, CN7), either one of two connectors is included with a product. Check the manufacturer name with the connector case.

Type	Model number (Manufacturer)
CN1 connector	MC1,5/6-STF-3,5 (PHOENIX CONTACT GmbH & Co. KG)
CN2 connector	721-203 (WAGO Corporation)
	or 54928-0370 (Molex Incorporated)
CN3 connector	721-207 (WAGO Corporation)
	or 54928-0770 (Molex Incorporated)
CN7 connector	Case: 10336-52A0-008 (3M Company) Connector: 10136-3000PE (3M Company)
	or Case: 54331-1361 (Molex Incorporated) Connector: 54306-3619 (Molex Incorporated)

8-2 How to identify the product model

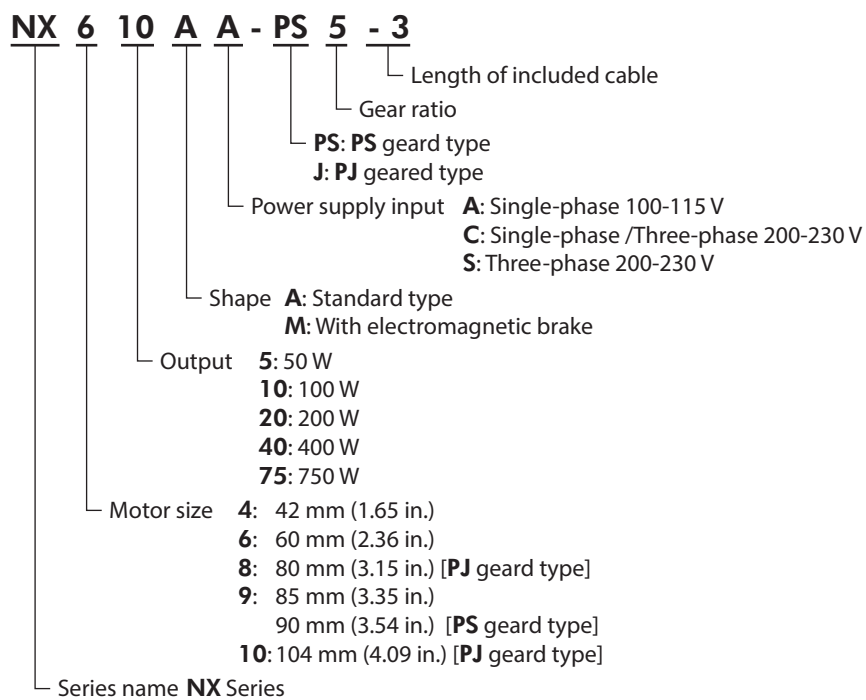

8-3 Combinations of motors and drivers

The box (□) in the model name indicates the cable length (1, 2, 3).

● Standard type

Model	Motor model	Driver model
NX45AA-□	NXM45A	NXD20-A
NX45AC-□	NXM45A	NXD20-C
NX410AA-□	NXM410A	NXD20-A
NX410AC-□	NXM410A	NXD20-C
NX620AA-□	NXM620A	NXD20-A
NX620AC-□	NXM620A	NXD20-C
NX640AS-□	NXM640A	NXD75-S
NX975AS-□	NXM975A	NXD75-S

● Standard type with electromagnetic brake

Model	Motor model	Driver model
NX45MA-□	NXM45M	NXD20-A
NX45MC-□	NXM45M	NXD20-C
NX410MA-□	NXM410M	NXD20-A
NX410MC-□	NXM410M	NXD20-C
NX620MA-□	NXM620M	NXD20-A
NX620MC-□	NXM620M	NXD20-C
NX640MS-□	NXM640M	NXD75-S
NX975MS-□	NXM975M	NXD75-S

● PS geared type

Model	Motor model	Driver model
NX65AA-PS5-□	NXM65A-PS5	NXD20-A
NX65AA-PS10-□	NXM65A-PS10	
NX65AA-PS25-□	NXM65A-PS25	
NX610AA-PS5-□	NXM610A-PS5	
NX610AA-PS10-□	NXM610A-PS10	
NX610AA-PS25-□	NXM610A-PS25	
NX920AA-PS5-□	NXM920A-PS5	
NX920AA-PS10-□	NXM920A-PS10	
NX920AA-PS25-□	NXM920A-PS25	NXD20-C
NX65AC-PS5-□	NXM65A-PS5	
NX65AC-PS10-□	NXM65A-PS10	
NX65AC-PS25-□	NXM65A-PS25	
NX610AC-PS5-□	NXM610A-PS5	
NX610AC-PS10-□	NXM610A-PS10	
NX610AC-PS25-□	NXM610A-PS25	
NX920AC-PS5-□	NXM920A-PS5	
NX920AC-PS10-□	NXM920A-PS10	NXD75-S
NX920AC-PS25-□	NXM920A-PS25	
NX940AS-PS5-□	NXM940A-PS5	
NX940AS-PS10-□	NXM940A-PS10	
NX940AS-PS25-□	NXM940A-PS25	

● PS geared type with electromagnetic brake

Model	Motor model	Driver model
NX65MA-PS5-□	NXM65M-PS5	NXD20-A
NX65MA-PS10-□	NXM65M-PS10	
NX65MA-PS25-□	NXM65M-PS25	
NX610MA-PS5-□	NXM610M-PS5	
NX610MA-PS10-□	NXM610M-PS10	
NX610MA-PS25-□	NXM610M-PS25	
NX920MA-PS5-□	NXM920M-PS5	
NX920MA-PS10-□	NXM920M-PS10	
NX920MA-PS25-□	NXM920M-PS25	NXD20-C
NX65MC-PS5-□	NXM65M-PS5	
NX65MC-PS10-□	NXM65M-PS10	
NX65MC-PS25-□	NXM65M-PS25	
NX610MC-PS5-□	NXM610M-PS5	
NX610MC-PS10-□	NXM610M-PS10	
NX610MC-PS25-□	NXM610M-PS25	
NX920MC-PS5-□	NXM920M-PS5	
NX920MC-PS10-□	NXM920M-PS10	NXD75-S
NX920MC-PS25-□	NXM920M-PS25	
NX940MS-PS5-□	NXM940M-PS5	
NX940MS-PS10-□	NXM940M-PS10	
NX940MS-PS25-□	NXM940M-PS25	

● PJ geared type

Model	Motor model	Driver model
NX810AA-J5-□	NXM810A-J5	NXD20-A
NX810AA-J10-□	NXM810A-J10	
NX810AA-J25-□	NXM810A-J25	
NX820AA-J5-□	NXM820A-J5	
NX820AA-J10-□	NXM820A-J10	
NX820AA-J25-□	NXM820A-J25	
NX810AC-J5-□	NXM810A-J5	NXD20-C
NX810AC-J10-□	NXM810A-J10	
NX810AC-J25-□	NXM810A-J25	
NX820AC-J5-□	NXM820A-J5	
NX820AC-J10-□	NXM820A-J10	
NX820AC-J25-□	NXM820A-J25	
NX1040AS-J5-□	NXM1040A-J5	NXD75-S
NX1040AS-J10-□	NXM1040A-J10	
NX1040AS-J25-□	NXM1040A-J25	
NX1075AS-J5-□	NXM1075A-J5	
NX1075AS-J10-□	NXM1075A-J10	
NX1075AS-J25-□	NXM1075A-J25	

● PJ geared type with electromagnetic brake

Model	Motor model	Driver model
NX810MA-J5-□	NXM810M-J5	NXD20-A
NX810MA-J10-□	NXM810M-J10	
NX810MA-J25-□	NXM810M-J25	
NX820MA-J5-□	NXM820M-J5	
NX820MA-J10-□	NXM820M-J10	
NX820MA-J25-□	NXM820M-J25	
NX810MC-J5-□	NXM810M-J5	NXD20-C
NX810MC-J10-□	NXM810M-J10	
NX810MC-J25-□	NXM810M-J25	
NX820MC-J5-□	NXM820M-J5	
NX820MC-J10-□	NXM820M-J10	
NX820MC-J25-□	NXM820M-J25	
NX1040MS-J5-□	NXM1040M-J5	NXD75-S
NX1040MS-J10-□	NXM1040M-J10	
NX1040MS-J25-□	NXM1040M-J25	
NX1075MS-J5-□	NXM1075M-J5	
NX1075MS-J10-□	NXM1075M-J10	
NX1075MS-J25-□	NXM1075M-J25	

8-4 Input/output power ratings

- The box (■) in the model name indicates **A** (single shaft) or **M** (with electromagnetic brake).
- The box (□) in the model name indicates the cable length (**1, 2, 3**).
- The box (◆) in the model name indicates a number representing the gear ratio.
- The motor model (UL recognized) apply to the condition before a gear part is assembled.

Model	Motor model	Motor model (UL recognized)	Driver model	Input
				Voltage
NX45■A-□	NXM45■	NXM45■	NXD20-A	Single-phase 100-115 V
NX45■C-□			NXD20-C	Single-phase/ Three-phase 200-230 V
NX410■A-□	NXM410■	NXM410■	NXD20-A	Single-phase 100-115 V
NX410■C-□			NXD20-C	Single-phase/ Three-phase 200-230 V
NX65■A-PS◆-□	NXM65■-PS◆	NXM45■	NXD20-A	Single-phase 100-115 V
NX65■C-PS◆-□			NXD20-C	Single-phase/ Three-phase 200-230 V
NX610■A-PS◆-□	NXM610■-PS◆	NXM410■	NXD20-A	Single-phase 100-115 V
NX610■C-PS◆-□			NXD20-C	Single-phase/ Three-phase 200-230 V
NX620■A-□	NXM620■	NXM620■	NXD20-A	Single-phase 100-115 V
NX620■C-□			NXD20-C	Single-phase/ Three-phase 200-230 V
NX640■S-□	NXM640■	NXM640■	NXD75-S	Three-phase 200-230 V
NX810■A-J◆-□	NXM810■-J◆	NXM610■-J	NXD20-A	Single-phase 100-115 V
NX810■C-J◆-□			NXD20-C	Single-phase/ Three-phase 200-230 V
NX820■A-J◆-□	NXM820■-J◆	NXM620■-J	NXD20-A	Single-phase 100-115 V
NX820■C-J◆-□			NXD20-C	Single-phase/ Three-phase 200-230 V
NX920■A-PS◆-□	NXM920■-PS◆	NXM620■	NXD20-A	Single-phase 100-115 V
NX920■C-PS◆-□			NXD20-C	Single-phase/ Three-phase 200-230 V
NX940■S-PS◆-□	NXM940■-PS◆	NXM640■	NXD75-S	Three-phase 200-230 V
NX975■S-□	NXM975■	NXM975■		
NX1040■S-J◆-□	NXM1040■-J◆	NXM940■-J		
NX1075■S-J◆-□	NXM1075■-J◆	NXM975■-J		

Input		Output				
Frequency	Current	Voltage	Frequency	Current	Output	
50/60 Hz	1.9 A	Three-phase 0-119 V	0-150 Hz	0.91 A	50 W	
	1.2 A/0.7 A					
	2.9 A	Three-phase 0-144 V		1.12 A	100 W	
	1.8 A/1.0 A					
	1.9 A	Three-phase 0-119 V		0.91 A	50 W	
	1.2 A/0.7 A					
	2.9 A	Three-phase 0-144 V		1.12 A	100 W	
	1.8 A/1.0 A					
	4.6 A	Three-phase 0-152 V		0-300 Hz	1.8 A	200 W
	2.8 A/1.6 A					
	2.8 A	Three-phase 0-162 V			3.2 A	400 W
	2.8 A					
	1.8 A/1.0 A	Three-phase 0-141 V			1.1 A	100 W
	4.6 A					
	2.8 A/1.6 A	Three-phase 0-152 V			1.8 A	200 W
	4.6 A					
	2.8 A/1.6 A					
	4.6 A					
2.8 A	Three-phase 0-162 V	3.2 A	400 W			
2.8 A						
4.7 A	Three-phase 0-160 V	5.9 A	750 W			
2.9 A						
4.7 A	Three-phase 0-127 V	5.1 A	400 W			
2.9 A						
4.7 A	Three-phase 0-160 V	5.9 A	750 W			
4.7 A						

8-5 Names and functions of parts

■ Motor (Example: NXM620M)

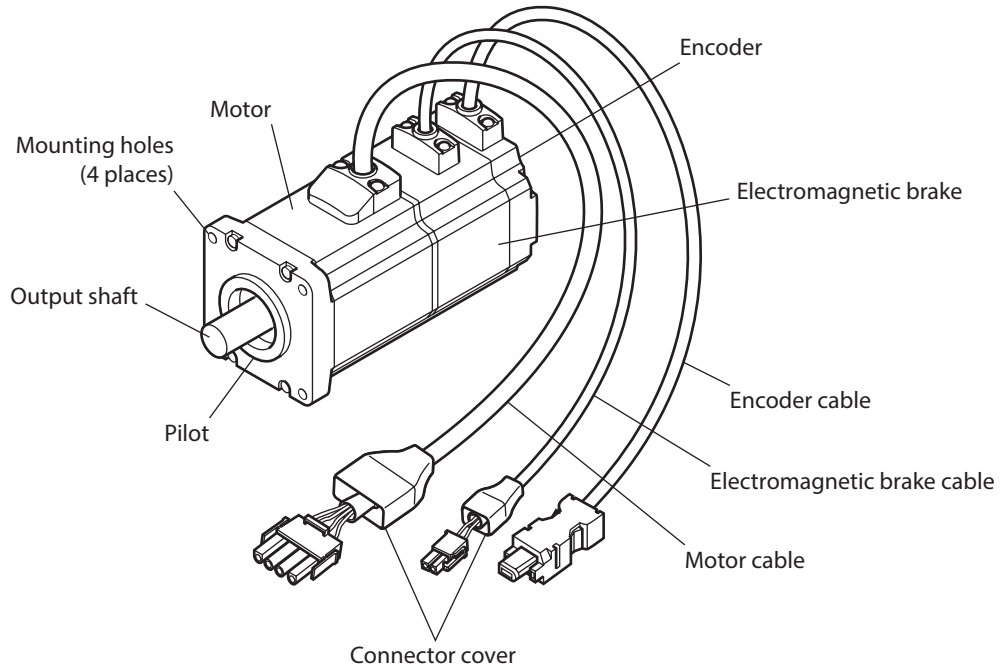

1 Before use

■ Driver (Example: NXD20-C)

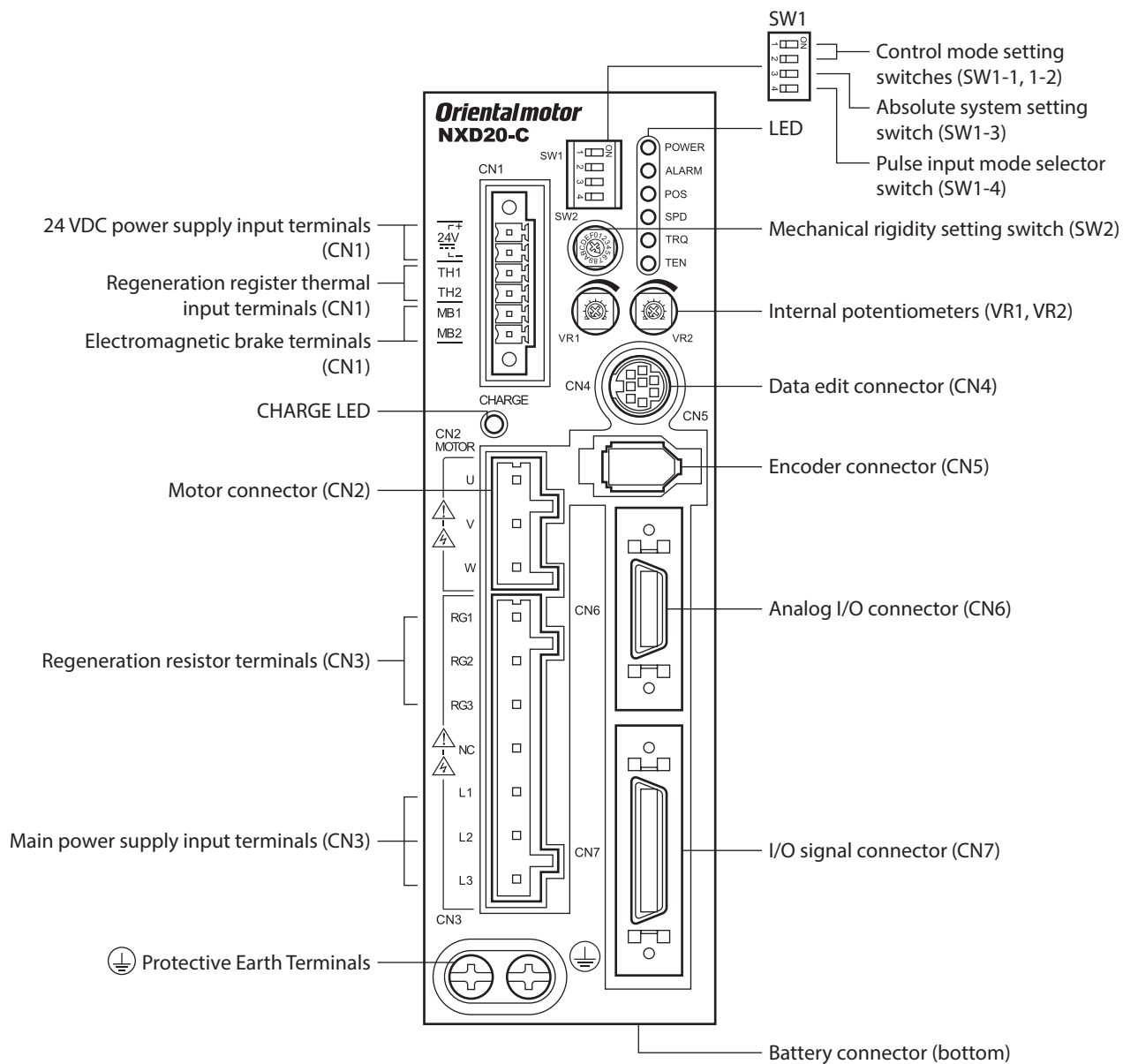

1 Before use

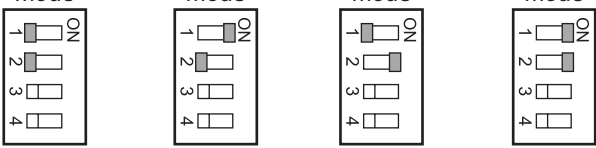
Name	Description	Reference	
Control mode setting switches (SW1-1, 1-2)	<p>These switches are used to set the control mode of the driver (position control, speed control, torque control or tension control).</p> <p>Position control mode Speed control mode Torque control mode Tension control mode</p> 	-	
Absolute system setting switch (SW1-3)	<p>This switch is effective in the position control mode. Set the switch when the absolute function of the driver is used by connecting our battery BAT01A.</p> <p>ON: Enable the absolute function OFF: Disable the absolute function (factory setting)</p>	p.71 p.79	
Pulse input mode selector switch (SW1-4)	<p>In the position control mode, this switch toggles the driver between the 1-pulse input mode and 2-pulse input mode according to the pulse output mode of the controller.</p> <p>ON: 1-pulse input mode, negative logic OFF: 2-pulse input mode, negative logic The factory setting depends on the destination country.</p>	p.69	
LED	<p>These LEDs indicate the status of the driver.</p> <ul style="list-style-type: none"> • POWER (green): This LED is lit while the main power supply or 24 VDC power supply is input. • ALARM (red): This LED will blink when an alarm generates (a protective function is triggered). You can check the generated alarm (triggered protective function) by counting the number of times the LED blinks. • POS (green): This LED is lit in the position control mode. • SPD (green): This LED is lit in the speed control mode. • TRQ (green): This LED is lit in the torque control mode. • TEN (green): This LED is lit in the tension control mode. 	-	
Mechanical rigidity setting switch (SW2)	<p>What is set with this switch varies depending on the control mode.</p>	p.84 p.111 - p.140	
	<ul style="list-style-type: none"> • Position control mode, speed control mode 		<p>This switch sets the gain adjustment level according to the mechanical rigidity. The factory setting is "6."</p>
	<ul style="list-style-type: none"> • Torque control mode 		<p>Not used.</p>
<ul style="list-style-type: none"> • Tension control mode 	<p>This switch sets the minimum speed in the simple mode. The factory setting is "6." The switch is not used in high function mode I or high function mode II.</p>		
Internal potentiometers (VR1, VR2)	<p>What is set with each switch varies depending on the control mode.</p>	p.91 - p.100 p.100 p.101 p.123 p.129 p.142 p.147 p.157	
	<ul style="list-style-type: none"> • Position control mode 		<p>VR1: This potentiometer sets the damping control frequency.</p> <p>VR2: Not used.</p>
	<ul style="list-style-type: none"> • Speed control mode 		<p>VR1: This potentiometer sets the speed command value.</p> <p>VR2: This potentiometer sets the acceleration/deceleration time.</p>
	<ul style="list-style-type: none"> • Torque control mode 		<p>VR1: This potentiometer sets the torque command value.</p> <p>VR2: This potentiometer sets the speed limit.</p>
	<ul style="list-style-type: none"> • Tension control mode 		<p>VR1: This potentiometer sets the tension command value.</p> <p>VR2: This potentiometer sets the speed limit.</p>

Name	Description	Reference
Data edit connector (CN4)	Connects a PC in which the MEXE02 has been installed, or the OPX-2A .	p.62
Encoder connector (CN5)	Connects the motor encoder via a cable for encoder.	p.45
Analog I/O connector (CN6)	Connects the analog I/O signals.	p.56
I/O signal connector (CN7)	Connects the I/O signals of the controller.	p.46
24 VDC power supply input terminals (CN1) [24V]	Connects a 24 VDC power supply. Once a 24 VDC power supply is connected, you can check the contents of alarms that have generated even when the main power supply is cut off. When an electromagnetic brake motor is used, be sure to connect a 24 VDC power supply for the electromagnetic brake.	p.60
Regeneration resistor thermal input terminals (CN1) [TH1, TH2]	Connects our regeneration resistor. If no regeneration resistor is connected, insert the CN1 connector to short the TH1 and TH2 terminals. The driver is shipped with a jumper wire preassembled in the CN1 connector, so you can short the terminals by simply connecting the connector.	p.60
Electromagnetic brake terminals (CN1) [MB1, MB2]	Connects the cable for electromagnetic brake (24 VDC). MB1: Electromagnetic brake – (black) MB2: Electromagnetic brake + (white)	p.45
CHARGE LED (red)	This LED is lit while the main power supply is input. After the main power supply has been turned off, the LED will turn off once the residual voltage in the driver drops to a safe level.	–
Motor connector (CN2)	Connects the motor. Phase U: Red Phase V: White Phase W: Black	p.45
Regeneration resistor terminals (CN3) [RG1, RG3]	When using the internal regeneration resistor, short the RG2 and RG3 terminals using a jumper wire included with the CN3 connector. If our regeneration resistor is used, remove the jumper wire which has shorted the RG2 and RG3 terminals, and connect the lead wires to the RG1 and RG3 terminals.	p.60
Main power supply input terminals (CN3)	<ul style="list-style-type: none"> • Single-phase 100-115 VAC L, N: Connects single-phase 100-115 VAC. • Single-phase 200-230 VAC L1, L2: Connects single-phase 200-230 VAC. L3: Not used. • Three-phase 200-230 VAC L1, L2, L3: Connects three-phase 200-230 VAC. • NC: Not used. 	p.58
Protective Earth Terminals	Ground this terminal using a grounding wire of AWG16 (1.25 mm ²) or larger.	p.59
Battery connector	Connects our battery BAT01A when using the absolute function of the driver in the position control mode.	p.62

2 Installation and connection

This part explains the installation method of the product, the mounting method of a load as well as connection method.

◆ Table of contents

1	Installation	34	2	Connection	44
1-1	Installation location	34	2-1	Connection method for connectors	44
1-2	Installing the motor	34	2-2	Connecting the motor	45
1-3	Installing a load	36	2-3	Connecting the I/O signals.....	46
1-4	Permissible radial load and permissible axial load.....	37	2-4	Connecting the analog I/O signals.....	56
1-5	Installing the driver.....	38	2-5	Connecting the power supply	58
1-6	Installing the regeneration resistor.....	40	2-6	Grounding the driver.....	59
1-7	Installing and wiring in compliance with EMC Directive.....	41	2-7	Connecting the 24 VDC power supply input, regeneration resistor and electromagnetic brake.....	59
			2-8	Connecting the battery	62
			2-9	Connecting the data setter	62

1 Installation

This chapter explains the installation location of the driver, installation method, and how to install the regeneration resistor.

Also covered in this section are the installation and wiring methods that are in compliance with the relevant EMC Directive.

1-1 Installation location

The motor and driver are designed and manufactured to be incorporated in equipment.

Install them in a well-ventilated location that provides easy access for inspection. The location must also satisfy the following conditions:

- Inside an enclosure that is installed indoors (provide vent holes)
- Operating ambient temperature
 - Motor: 0 to +40 °C (+32 to +104 °F) (non-freezing)
 - Driver: 0 to +50 °C (+32 to +122 °F) (non-freezing)
- Operating ambient humidity 85 % or less (non-condensing)
- Operating surrounding atmosphere
 - Motor: Area free of explosive atmosphere or toxic gas (such as sulfuric gas)
Area not subject to oil (oil droplets)
 - Driver: Area free of explosive atmosphere or toxic gas (such as sulfuric gas) or liquid
Area not subject to splashing water (rain, water droplets), oil (oil droplets) or other liquids
- Area not exposed to direct sun
- Area free of excessive amount of dust, iron particles or the like
- Area free of excessive salt
- Area not subject to continuous vibrations or excessive shocks
- Area free of excessive electromagnetic noise (from welders, power machinery, etc.)
- Area free of radioactive materials, magnetic fields or vacuum
- Up to 1,000 m (3,300 ft.) above sea level

1-2 Installing the motor

■ Installation direction

The motor can be installed in any direction. There is an exception, however, in humid places, areas subject to mist and other environments where water accumulates easily. In such environments, the motor should be installed in the direction whereby the motor cable extends downward.

■ Installation method

To allow for prevent vibration, install the motor on a metal surface of sufficient strength. Install the motor in a location where heat dissipation capacity equivalent to a level achieved with a heat sink (made of aluminum) is ensured. Refer to the table for the heat sink.

Motor model	Heat sink size [mm (in.)]
NXM45, NXM410, NXM620, NXM65-PS□, NXM610-PS□, NXM920-PS□, NXM810-J□, NXM820-J□	250×250×6 (9.84×9.84×0.24)
NXM640, NXM940-PS□, NXM1040-J□	300×300×10 (11.81×11.81×0.39)
NXM975, NXM1075-J□	350×350×10 (13.78×13.78×0.39)

* The box (□) in the model name indicates a number representing the gear ratio.

● **Motor frame size: 42 mm (1.65 in.)**

Secure at the two mounting holes according to the installation method appropriate for your specific method of use.

● **Installation method A**

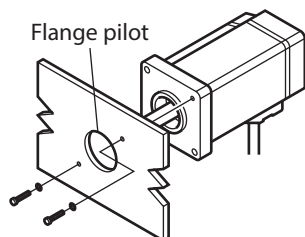

● **Installation method B**

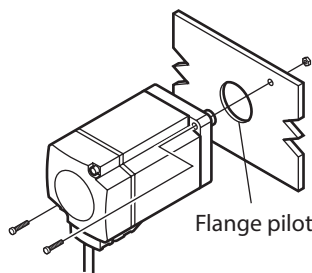

Motor type	Frame size [mm (in.)]	Nominal size	Tightening torque [N·m (oz-in)]	Effective depth of screw thread [mm (in.)]	Installation method
Standard	42 (1.65)	M3	1 (142)	6 (0.24)	A
				–	B

● **Motor frame size: 60 to 104 mm (2.36 to 4.09 in.)**

Secure at the four mounting holes according to the installation method appropriate for your specific method of use.

● **Installation method C**

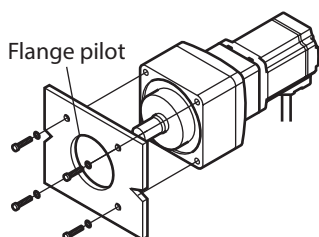

● **Installation method D**

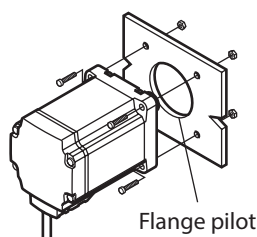

Motor type	Frame size [mm (in.)]	Nominal size	Tightening torque [N·m (oz-in)]	Effective depth of screw thread [mm (in.)]	Installation method
Standard	60 (2.36)	M4	2 (280)	–	D
	85 (3.35)	M6	3 (420)		
PS geared	60 (2.36)	M5	2.5 (350)	10 (0.39)	C
	90 (3.54)	M8	4 (560)	15 (0.59)	
PJ geared	80 (3.15)	M6	9 (1,270)	–	D
	104 (4.09)	M8	15 (2,100)		

Note

Since the tightening torque of the **PJ** geared type is large, using a mechanically weak mounting plate or screws may cause damage. Satisfy the following conditions for the mounting plate and screws. Also, be sure to tighten with the specified torque.

Material of mounting plate: Steel

Mounting screw: Use a screw which tensile strength ranking is 12.9 or higher

■ **Note for when the installation method B or D is used**

If washers are used with the installation method B or D, make sure the washer type and size are correct. The washers may come into contact with the motor flange, causing improper installation. Refer to the table, and use suitable washers in which the screws are completely seated.

Frame size [mm (in.)]	Nominal size	Outer diameter of washer [mm (in.)]
42 (1.65)	M3	ø5.9 (0.23) or less
60 (2.36)	M4	ø8.6 (0.34) or less
85 (3.35)	M6	ø12 (0.47) or less

1-3 Installing a load

When connecting a load to the motor, align the centers of the motor output shaft and load shaft. Be careful not to damage the output shaft or the bearings (ball bearings) when installing a coupling or pulley to the motor output shaft.

■ **Electromagnetic brake motor**

To release the electromagnetic brake and install the load, a DC power supply is needed to power the electromagnetic brake. Use a cable for electromagnetic brake to connect a DC power supply of 24 VDC±10 % to the motor. The cable for electromagnetic brake is included with the electromagnetic brake motor and driver packages.

*1 The current capacities of the power supply are as follows.

NX975, NX1040, NX1075: 0.8 A or more
Motors other than the above types: 0.7 A or more

*2 The customer is provide a varistor to protect the contact of the switch or to prevent electrical noise.

[Recommended varistor: Z15D121 (SEMITEC Corporation)].

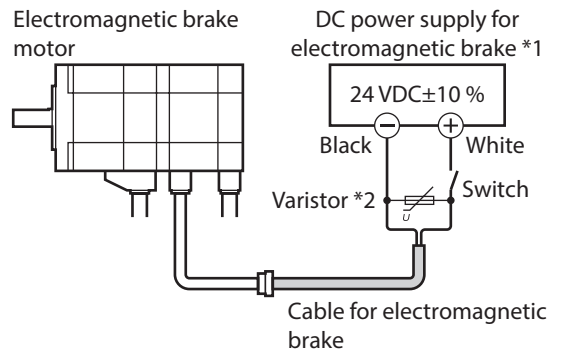

■ **PJ geared type**

With a **PJ** geared type, a load can be installed directly to the gear using the load mounting screw holes (6 places) provided on the flange surface.



Since the tightening torque for the load mounting screw is large, using a mechanically weak load or screws may cause damage. Satisfy the following conditions for the load and mounting screws. Also, be sure to tighten with the specified torque.

Material of load: Steel

Mounting screw: Use a screw which tensile strength ranking is 12.9 or higher

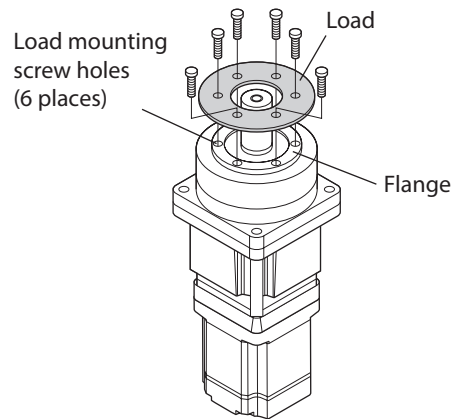

Motor model	Nominal size	Number of screws	Tightening torque [N·m (oz-in)]	Effective depth of screw thread [mm (in.)]
NXM810 NXM820	M6	6	9 (1,270)	12 (0.47)
NXM1040 NXM1075	M8	6	15 (2,100)	15 (0.59)

1-4 Permissible radial load and permissible axial load

Note If the radial load or axial load exceeds the specified allowable value, repeated load applications may cause the bearing (ball bearings) or output shaft of the motor to undergo a fatigue failure.

memo The permissible radial load and permissible axial load of the **PS** geared type represent the value that the service life of the gear part satisfies 20,000 hours when either of the radial load or axial load is applied to the gear output shaft.

Type	Model *	Permissible radial load [N (lb.)]								Permissible axial load [N (lb.)]
		Distance from the tip of motors output shaft [mm (in.)]								
		0 (0)	5 (0.2)	10 (0.39)	15 (0.59)	20 (0.79)	25 (0.98)	30 (1.18)	35 (1.38)	
Standard	NX45 NX410	81 (18.2)	88 (19.8)	95 (21)	104 (23)	–	–	–	–	59 (13.2)
	NX620 NX640	230 (51)	245 (55)	262 (58)	281 (63)	304 (68)	–	–	–	98 (22)
	NX975	376 (84)	392 (88)	408 (91)	426 (95)	446 (100)	467 (105)	491 (110)	–	147 (33)
PS geared	NX6□-PS5	170 (38)	200 (45)	230 (51)	270 (60)	320 (72)	–	–	–	200 (45)
	NX6□-PS10	220 (49)	250 (56)	290 (65)	350 (78)	410 (92)	–	–	–	
	NX6□-PS25	300 (67)	340 (76)	400 (90)	470 (105)	560 (126)	–	–	–	
	NX9□-PS5	380 (85)	420 (94)	470 (105)	540 (121)	630 (141)	–	–	–	600 (135)
	NX9□-PS10	480 (108)	530 (119)	590 (132)	680 (153)	790 (177)	–	–	–	
	NX9□-PS25	650 (146)	720 (162)	810 (182)	920 (200)	1070 (240)	–	–	–	
PJ geared	NX8□-J5	300 (67)	330 (74)	350 (78)	380 (85)	400 (90)	430 (96)	460 (103)	500 (112)	300 (67)
	NX8□-J10	450 (101)	480 (108)	510 (114)	540 (121)	570 (128)	610 (137)	650 (146)	700 (157)	400 (90)
	NX8□-J25	680 (153)	710 (159)	750 (168)	780 (175)	840 (189)	900 (200)	950 (210)	1,000 (220)	600 (135)
	NX10□-J5	650 (146)	700 (157)	730 (164)	750 (168)	800 (180)	830 (186)	880 (198)	920 (200)	500 (112)
	NX10□-J10	900 (200)	950 (210)	1,000 (220)	1,050 (230)	1,100 (240)	1,180 (260)	1,230 (270)	1,300 (290)	650 (146)
	NX10□-J25	1,350 (300)	1,400 (310)	1,480 (330)	1,550 (340)	1,600 (360)	1,650 (370)	1,750 (390)	1,850 (410)	1,000 (220)

* The box (□) in the model name indicates a number representing the output.

■ Permissible moment load of the PJ geared type

When installing an arm or table on the flange surface, calculate the moment load using the formula below if the flange surface receives any eccentric load. The moment load should not exceed the permissible value specified in the table.

Moment load: $M [N\cdot m (lb\cdot in)] = F \times L$

Model *	Permissible moment load [N·m (lb·in)]
NX8□-J5	16 (140)
NX8□-J10	33 (290)
NX8□-J25	60 (530)
NX10□-J5	30 (260)
NX10□-J10	66 (580)
NX10□-J25	120 (1,060)

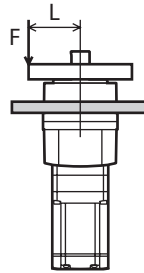

* The box (□) in the model name indicates a number representing the output.

1-5 Installing the driver

The driver is designed so that heat is dissipated via air convection and conduction through the enclosure. When two or more drivers are to be installed side by side, provide 20 mm (0.79 in.) and 50 mm (1.97 in.) clearances in the horizontal and vertical directions, respectively. When installing the driver inside an enclosure, use two screws (three screws for NXD75-S) to secure the driver through the mounting holes. Screws (M4) are not included. Please provide separately.

• NXD20-A, NXD20-C

• NXD75-S

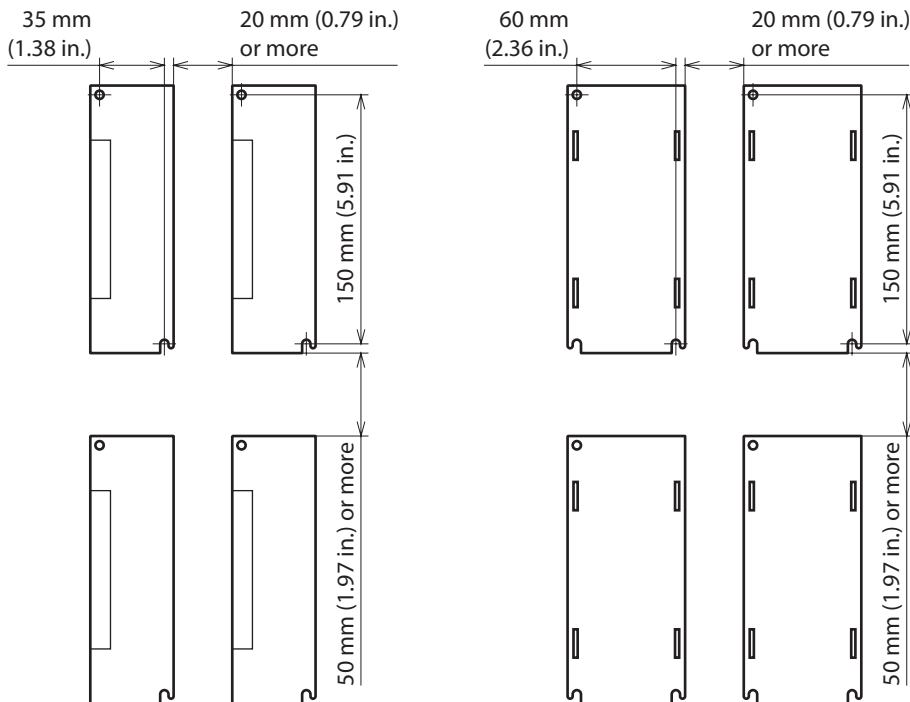

- Install the driver inside an enclosure whose pollution degree is 2 or above or protection class is IP54 or better.
- Do not install any equipment that generates a large amount of heat or noise near the driver.
- Do not install the driver underneath the controller or other equipment vulnerable to heat.
- If the ambient temperature of the driver exceeds 50 °C (122 °F), reconsider the ventilation condition.
- Be sure to install (position) the driver vertically.

Dimension [unit: mm (in.)]

NXD20-A, NXD20-C

Mass: 0.9 kg (1.98 lb.)

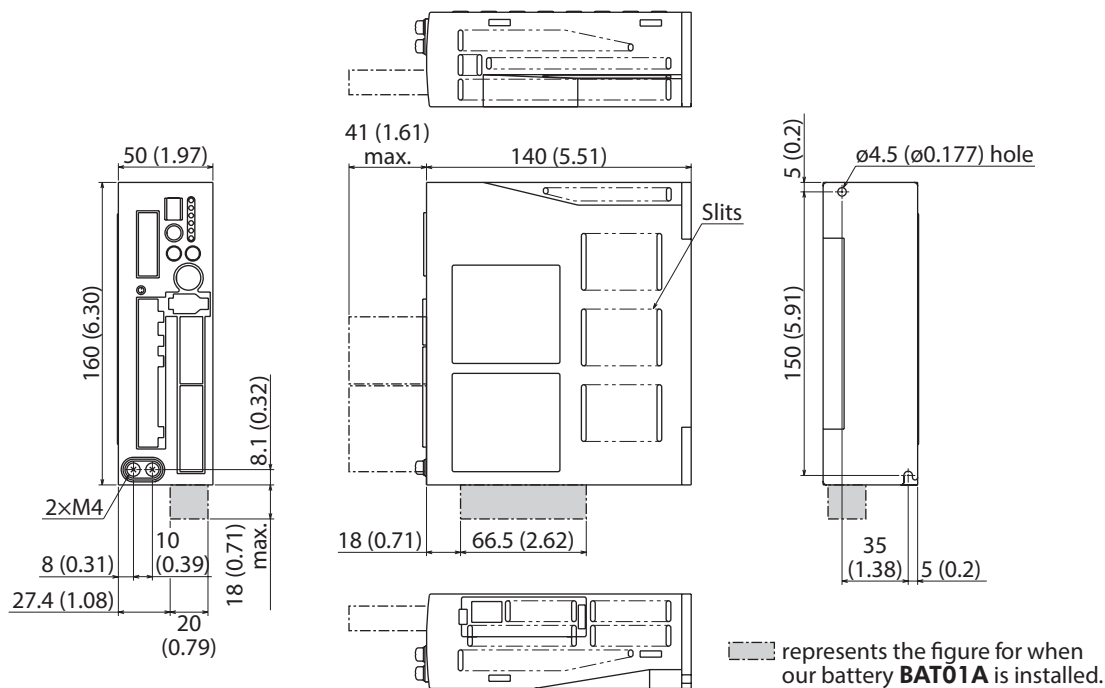

NXD75-S

Mass: 1.6 kg (3.5 lb.)

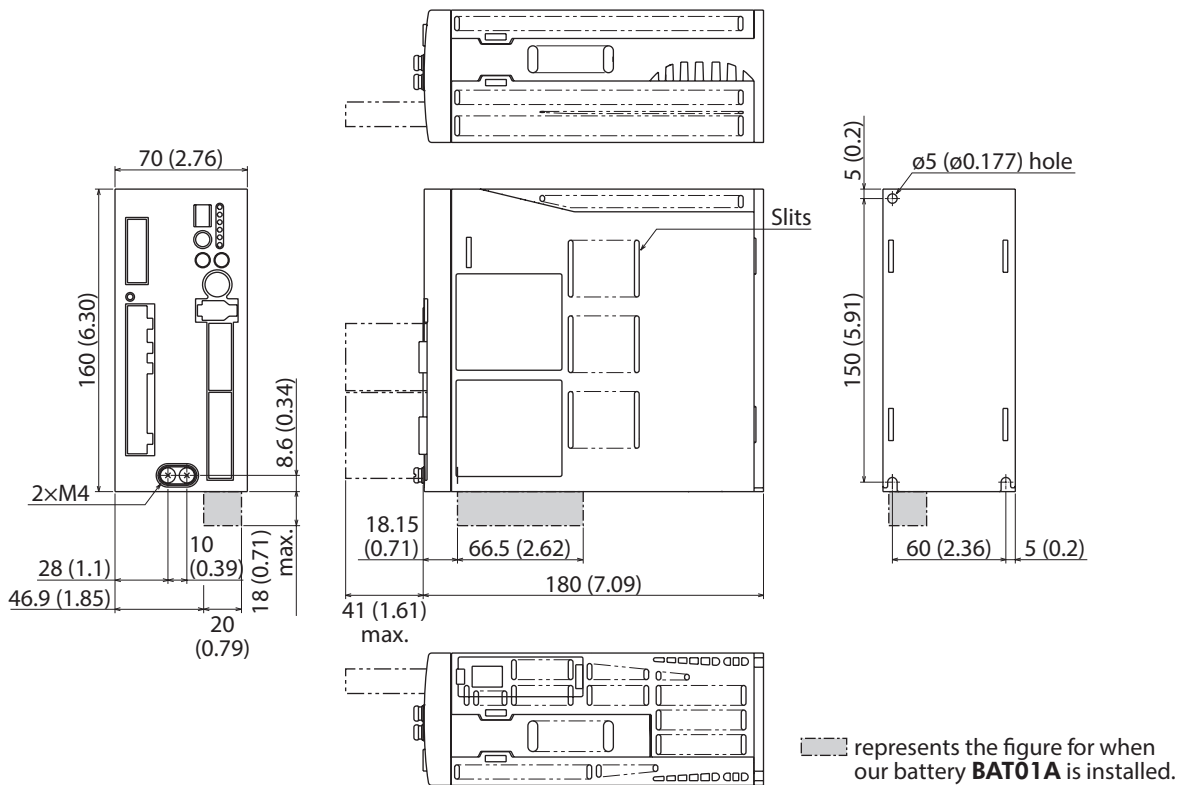

1-6 Installing the regeneration resistor

Regeneration resistors (our products) vary based upon the model of the driver used.

■ NXD20-A and NXD20-C

Use a regeneration resistor **RGB100**.

Install the **RGB100** in a location where heat dissipation capacity equivalent to a level achieved with a heat sink [made of aluminum, 350×350×3 mm (13.78×13.78×0.12 in.)] is ensured. Secure the **RGB100** on a smooth metal plate offering high heat conductivity, using two screws (M4, not included).

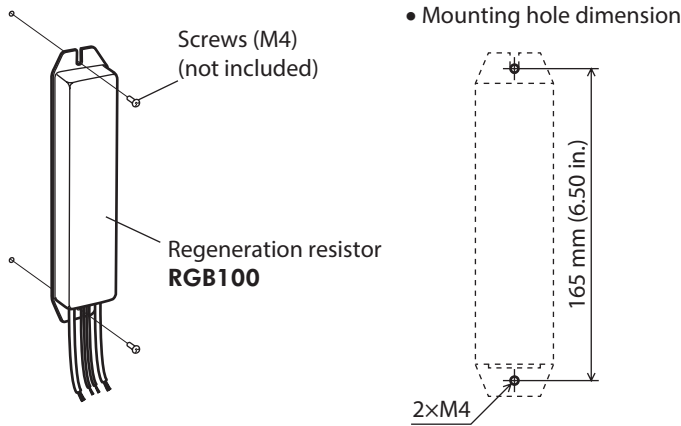

■ NXD75-S

Use a regeneration resistor **RGB200**.

Install the **RGB200** in a location where heat dissipation capacity equivalent to a level achieved with a heat sink [made of aluminum, 350×350×3 mm (13.78×13.78×0.12 in.)] is ensured. Secure the **RGB200** main unit on a smooth metal plate offering high heat conductivity, using two screws (M4, not included).

Then, put the protective cover on the **RGB200** main unit using four screws (M4, not included).

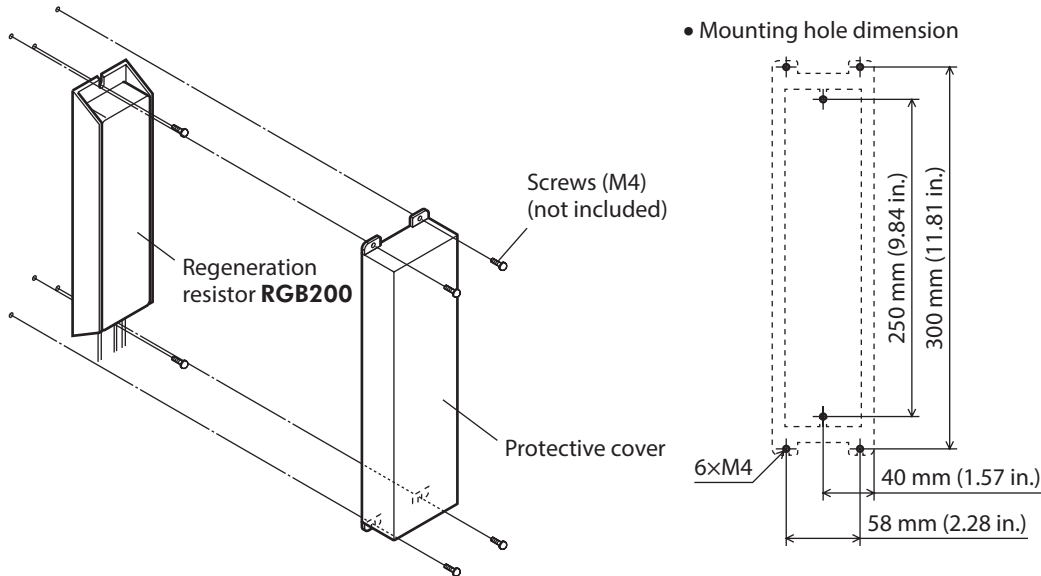

⚠ CAUTION

Use the regeneration resistor with the protective cover and do not touch during operation or immediately after stopping. The surface is hot and may cause skin burn(s).

1-7 Installing and wiring in compliance with EMC Directive

Effective measures must be taken against the EMI that the motor and driver may give to adjacent control-system equipment, as well as the EMS of the motor and driver itself, in order to prevent a serious functional impediment in the machinery. The use of the following installation and wiring methods will enable the driver to be compliant with the EMC directive. Refer to “EMC Directive” on p.21 for the applicable standards.

EMI emitting noise changes according to the layout of the product or the wiring of the cables. If the noise generated by the cable causes a problem, insert ferrite cores in the cable.

■ Connecting noise filter for power supply line

Connect a noise filter in the AC input line to prevent the noise generated in the driver from propagating externally through the power supply line.

Use a following noise filter or equivalent.

Driver model	Manufacturer	Single-phase 100-115 V	Single-phase 200-230 V	Three-phase 200-230 V
NXD20-A NXD20-C	SOSHIN ELECTRIC CO., LTD.	HF2010A-UPF	–	–
	Schaffner EMC	–	HF2010A-UPF	HF3010C-SZA
NXD75-S	TDK-Lambda Corporation	–	–	RTHN-5010

- Install the noise filter as close to the driver as possible.
- Use cable clamp or others to secure the input and output cables firmly to the surface of the enclosure.
- Connect the ground terminal of the noise filter to the grounding point, using as thick and short a wire as possible.
- Do not place the AC input cable (AWG16 to 14: 1.25 to 2.0 mm²) parallel with the noise filter output cable (AWG16 to 14: 1.25 to 2.0 mm²). Parallel placement will reduce noise filter effectiveness if the enclosure's internal noise is directly coupled to the power supply cable by means of stray capacitance.

■ Connecting a surge arrester

Use a following surge arrester.

Manufacturer	Single-phase 100-115 V, 200-230 V	Three-phase 200-230 V
OKAYA ELECTRIC INDUSTRIES CO., LTD.	R-C-M-601BQZ-4	R-C-M-601BUZ-4
SOSHIN ELECTRIC CO., LTD.	LT-C12G801WS	LT-C32G801WS



When measuring dielectric strength of the equipment, be sure to remove the surge arrester, or the surge arrester may be damaged.

■ Connecting the 24 VDC power supply

Use a 24 VDC power supply conforming to the EMC Directive.

Use a shielded cable for wiring, and wire/ground the power supply cable over the shortest possible distance. Refer to “Wiring the power supply cable and signal cable” on p.42 for how to ground the shielded cable.

■ How to ground

The cable used to ground the driver, motor and noise filter must be as thick and short as possible so that no potential difference is generated. Choose a large, thick and uniformly conductive surface for the grounding point.

● How to ground the driver

Refer to p.59 for how to ground the driver.

● How to ground the motor

Connect the Protective Earth wire of the cable for motor, to the Protective Earth Terminal on the driver.

■ Wiring the power supply cable and signal cable

- Use a shielded cable of AWG16 to 14 (1.25 to 2.0 mm²) or larger for the main power supply.
- Use a shielded cable of AWG28 to 16 (0.08 to 1.25 mm²) for the 24 VDC power supply.
- Use a shielded cable of AWG28 (0.08 mm²) or more for the I/O signal cable. Driver cables are provided as our products. Check the model names on p.219.
- Wire the cables as short as possible.
- To ground a shielded cable, use a metal clamp or similar device that will maintain contact with the entire circumference of the shielded cable. Attach a cable clamp as close to the end of the cable as possible, and connect it as shown in the figure.

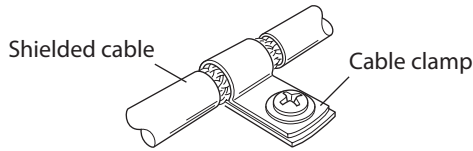

■ Notes about installation and wiring

- Connect the motor, driver and other peripheral control equipment directly to the grounding point so as to prevent a potential difference from developing between grounds.
- When relays or electromagnetic switches are used together with the system, use noise filters and CR circuits to suppress surges generated by them.
- Keep cables as short as possible without coiling and bundling extra lengths.
- Place the power cables such as the motor and power supply cables as far apart [200 mm (7.87 in.)] as possible from the signal cables. If they have to cross, cross them at a right angle. Place the AC input cable and output cable of a noise filter separately from each other.
- Use our connection cable or extension cable when extending the wiring distance between the motor and the driver. Check the model names on p.214. The EMC measures are conducted using our cable.

■ Example of installation and wiring

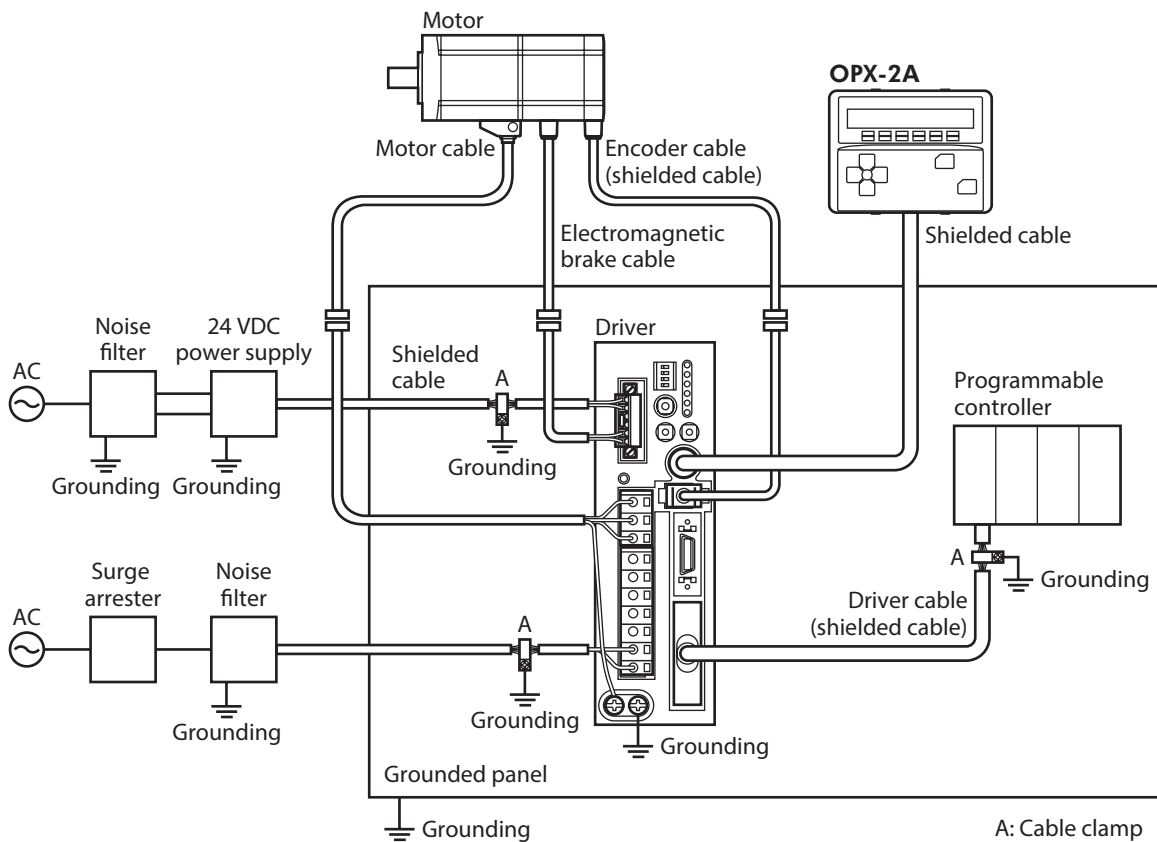

■ Precautions about static electricity

Static electricity may cause the driver to malfunction or suffer damage. While the driver is receiving power, handle the driver with care and do not come near or touch the driver.

Always use an insulated screwdriver to adjust the driver's switches.



The driver uses parts that are sensitive to electrostatic charge. Before touching the driver, turn off the power to prevent electrostatic charge from generating. If electrostatic charge is impressed on the driver, the driver may be damaged.

2 Connection

This chapter explains the driver, motor, I/O signals, how to connect the power supply, and grounding method.

2-1 Connection method for connectors

■ Wiring the CN1 connector

- Applicable lead wire: AWG28 to 16 (0.08 to 1.25 mm²)
- Stripping length of wire insulation: 7 mm (0.28 in.)
- Nominal size: M2
- Tightening torque: 0.22 to 0.25 N·m (31 to 35 oz-in)

Insert each lead wire into the CN1 connector and tighten the screw using a slotted screwdriver.

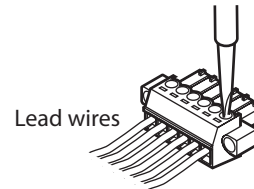

■ Wiring the CN2/CN3 connectors

- Applicable lead wire: AWG16 to 14 (1.25 to 2.0 mm²)
- Stripping length of wire insulation: 8 to 9 mm (0.31 to 0.35 in.)

1. Insert the connector wiring lever.
2. Insert the lead wire while pushing down the connector wiring lever.

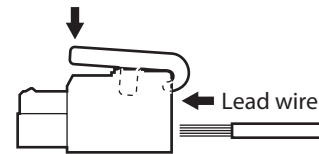

You can also use a slotted screwdriver.

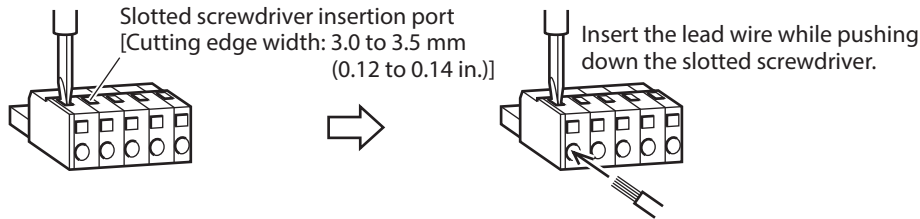

■ Wiring the CN6/CN7 connectors

- Applicable lead wire: AWG28 to 24 (0.08 to 0.2 mm²)

The tightening torque of a screw varies depending on the manufacturer of the connector. Check the manufacturer and tightening torque of the connector before tightening the screw. Check the manufacturer name with the connector case.

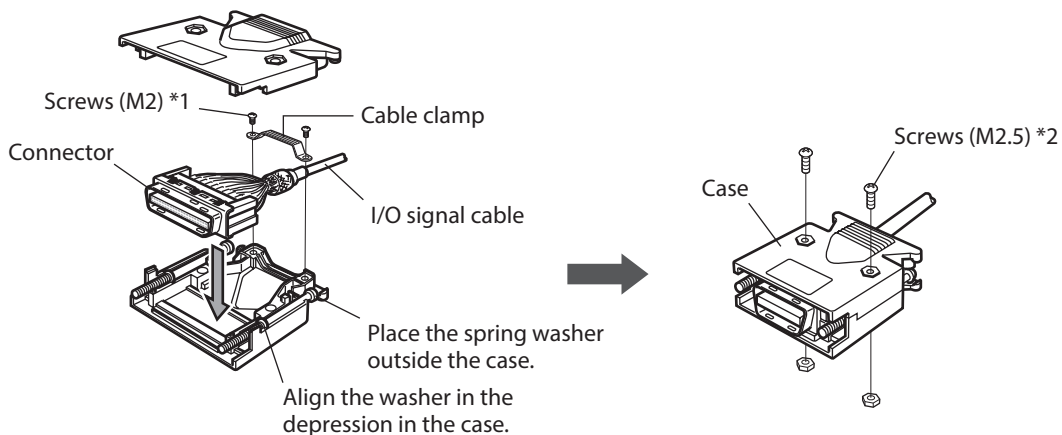

*1 The tightening torque is shown in the table.

Manufacturer of connector	Tightening torque [N·m (oz-in)]
3M Company	0.15 to 0.25 (21 to 35)
Molex Incorporated	0.3 to 0.35 (42 to 49)

*2 The tightening torque is shown in the table.

Manufacturer of connector	Tightening torque [N·m (oz-in)]
3M Company	0.16 to 0.2 (22 to 28)
Molex Incorporated	0.5 to 0.55 (71 to 78)

2-2 Connecting the motor

■ Example: electromagnetic brake motor

Refer to p.59 for the connection method of 24 VDC power supply.

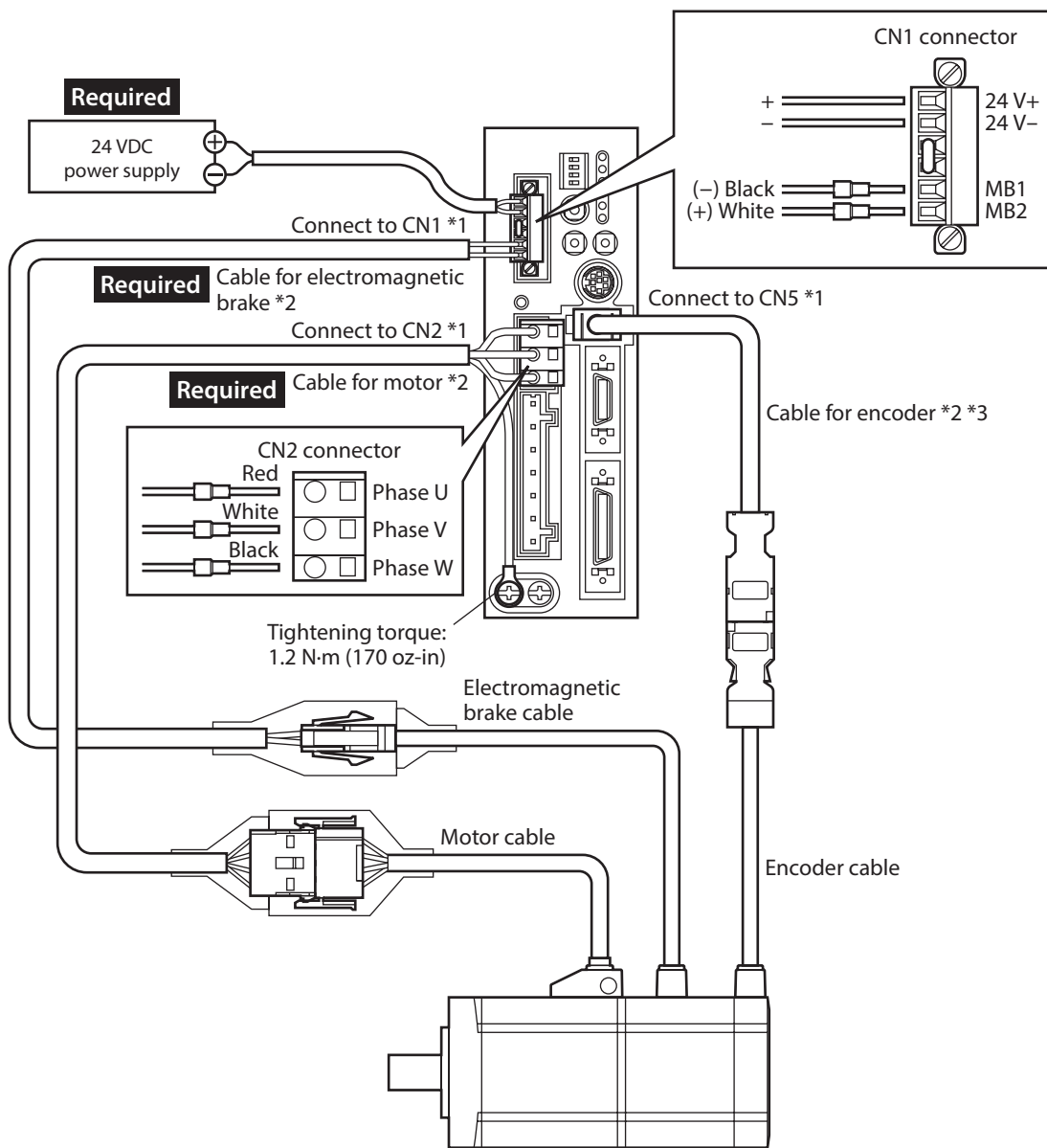

*1 Keep 20 m (65.6 ft.) or less for the extension length between the motor and driver.

*2 These cables are provided as our products. These cables are included with the product or sold separately.

*3 Use the cable for encoder when the length of the encoder cable of motor is not enough.

- Note**
- The lead wires of the cable for electromagnetic brake have polarities, so connect them in the correct polarity. If the lead wires are connected with their polarities reversed, the electromagnetic brake will not operate properly.
 - Connect the connectors securely. Insecure connector connection may cause malfunction or damage to the motor or driver.
 - When connecting or disconnecting the connector, turn off the power and wait for the CHARGE LED to turn off before doing so. The residual voltage may cause electric shock.

memo When installing the motor on a moving part, use our flexible cable offering excellent flexibility. Check the model names on p.214.

2-3 Connecting the I/O signals

Solder the I/O signal cable (AWG28 to 24: 0.08 to 0.2 mm²) to the CN7 connector (36 pins) by checking the pin numbers in "Connector function tables" provided on p.47 and pages that follow. Use a shielded cable for I/O signals. Refer to p.44 for wiring the connectors. We provide an driver cable allowing simple and easy connection with a driver, as well as the connector-terminal block conversion unit. Check the model names on p.220.

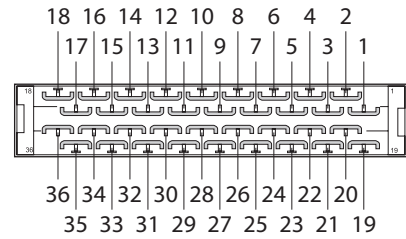

■ Connecting the connector (CN7)

Insert the CN7 connector into the I/O signal connector (CN7) on the driver, and tighten the screws. The tightening torque of a screw varies depending on the manufacturer of the connector. Check the manufacturer and tightening torque of the connector before tightening the screw. Check the manufacturer name with the connector case.

Manufacturer of connector	Tightening torque [N·m (oz-in)]
3M Company	0.15 to 0.25 (21 to 35)
Molex Incorporated	0.3 to 0.35 (42 to 49)

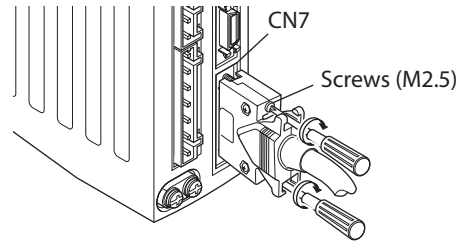

Be certain the I/O signal cable is as short as possible. The maximum input frequency will decrease as the cable length increases.

■ Connector function table – Position control mode

Pin No.	Signal name	Name
1	–	–
2	GND	Ground connection
3	ASG+	A-phase pulse line-driver output
4	ASG–	
5	BSG+	B-phase pulse line-driver output
6	BSG–	
7	ZSG1+	Z-phase pulse line-driver output
8	ZSG1–	
9	ALM+	Alarm output
10	ALM–	
11	WNG+/MOVE+ */MBC+ *	Warning output/ Motor moving output */ Electromagnetic brake control signal output *
12	WNG–/MOVE– */MBC– *	
13	END+	Positioning complete output
14	END–	
15	READY+/AL0+ */P-OUTR+	Operation ready complete output/Alarm code output bit0 */ Position data output ready output
16	READY–/AL0– */P-OUTR–	
17	TLC+/AL1+ */P-OUT0+	Torque limit output /Alarm code output bit1 */ Position data output bit0
18	TLC–/AL1– */P-OUT0–	
19	ZSG2+/NEAR+ */AL2+ */P-OUT1+	Z-phase pulse open-collector output/Near position output */ Alarm code output bit2 */Position data output bit1
20	ZSG2–/NEAR– */AL2– */P-OUT1–	
21	GND	Ground connection
22	IN-COM	Input common
23	S-ON	Servo on input
24	CLR/ALM-RST/P-CK	Deviation clear input/Alarm reset input/ Position data transmission clock input
25	P-REQ	Position data request input
26	TL	Torque limit enable input
27	M0	Data selection input
28	M1	
29	P-PRESET	Position preset input
30	FREE	Shaft free input
31	CW+/PLS+	CW pulse input/Pulse input (+5 V)
32	CW–/PLS–	
33	CW+24 V/PLS+24 V	CW pulse/Pulse input (+24 V)
34	CCW+24 V/DIR+24 V	CCW pulse input/Direction input (+24 V)
35	CCW+/DIR+	CCW pulse input/Direction input (+5 V)
36	CCW–/DIR–	

* The signal will become effective if the applicable setting has been changed using the **MEXE02** or the **OPX-2A**.

■ Connector function table – Speed control mode

Pin No.	Signal name	Name
1	–	–
2	GND	Ground connection
3	ASG+	A-phase pulse line-driver output
4	ASG–	
5	BSG+	B-phase pulse line-driver output
6	BSG–	
7	ZSG1+	Z-phase pulse line-driver output
8	ZSG1–	
9	ALM+	Alarm output
10	ALM–	
11	WNG+/MOVE+ */MBC+ *	Warning output/ Motor moving output */ Electromagnetic brake control signal output *
12	WNG–/MOVE– */MBC– *	
13	VA+	Speed attainment output
14	VA–	
15	READY+/AL0+ *	Operation ready complete output/Alarm code output bit0 *
16	READY–/AL0– *	
17	TLC+/AL1+ *	Torque limit output /Alarm code output bit1 *
18	TLC–/AL1– *	
19	ZSG2+/ZV+ */AL2+ *	Z-phase pulse open-collector output/ Motor zero speed output */ Alarm code output bit2 *
20	ZSG2–/ZV– */AL2– *	
21	GND	Ground connection
22	IN-COM	Input common
23	S-ON	Servo on input
24	ALM-RST	Alarm reset input
25	BRAKE	Instantaneous stop input
26	TL	Torque limit enable input
27	M0	Data selection input
28	M1	
29	M2	
30	FREE	Shaft free input
31	CW+	CW input (+5 V)
32	CW–	
33	CW+24 V	CW input (+24 V)
34	CCW+24 V	CCW input (+24 V)
35	CCW+	CCW input (+5 V)
36	CCW–	

* The signal will become effective if the applicable setting has been changed using the **MEXE02** or the **OPX-2A**.

■ Connector function table – Torque control mode

Pin No.	Signal name	Name
1	–	–
2	GND	Ground connection
3	ASG+	A-phase pulse line-driver output
4	ASG–	
5	BSG+	B-phase pulse line-driver output
6	BSG–	
7	ZSG1+	Z-phase pulse line-driver output
8	ZSG1–	
9	ALM+	Alarm output
10	ALM–	
11	WNG+/MOVE+*/MBC+*	Warning output/ Motor moving output*/ Electromagnetic brake control signal output*
12	WNG–/MOVE–*/MBC–*	
13	–	–
14	–	–
15	READY+/AL0+*	Operation ready complete output/Alarm code output bit0*
16	READY–/AL0–*	
17	VLC+/AL1+*	Speed limit output/Alarm code output bit1*
18	VLC–/AL1–*	
19	ZSG2+/ZV+*/AL2+*	Z-phase pulse open-collector output/ Motor zero speed output*/ Alarm code output bit2*
20	ZSG2–/ZV–*/AL2–*	
21	GND	Ground connection
22	IN-COM	Input common
23	–	–
24	ALM-RST	Alarm reset input
25	–	–
26	–	–
27	M0	Data selection input
28	M1	
29	M2	
30	FREE	Shaft free input
31	CW+	CW input (+5V)
32	CW–	
33	CW+24 V	CW input (+24 V)
34	CCW+24 V	CCW input (+24 V)
35	CCW+	CCW input (+5 V)
36	CCW–	

* The signal will become effective if the applicable setting has been changed using the **MEXE02** or the **OPX-2A**.

■ Connector function table – Tension control mode

Pin No.	Signal name	Name
1	–	–
2	GND	Ground connection
3	ASG+	A-phase pulse line-driver output
4	ASG–	
5	BSG+	B-phase pulse line-driver output
6	BSG–	
7	ZSG1+	Z-phase pulse line-driver output
8	ZSG1–	
9	ALM+	Alarm output
10	ALM–	
11	WNG+/MOVE+ */MBC+ *	Warning output/ Motor moving output */ Electromagnetic brake control signal output *
12	WNG–/MOVE– */MBC– *	
13	–	–
14	–	–
15	READY+/AL0+ *	Operation ready complete output/Alarm code output bit0 *
16	READY–/AL0– *	
17	VLC+/AL1+ *	Speed limit output/Alarm code output bit1 *
18	VLC–/AL1– *	
19	ZSG2+/ZV+ */AL2+ *	Z-phase pulse open-collector output/ Motor zero speed output */ Alarm code output bit2 *
20	ZSG2–/ZV– */AL2– *	
21	GND	Ground connection
22	IN-COM	Input common
23	–	–
24	ALM-RST	Alarm reset input
25	–	–
26	W-RESET	Roll diameter reset input
27	M0	Data selection input
28	M1	
29	M2	
30	FREE	Shaft free input
31	CW+	CW input (+5 V)
32	CW–	
33	CW+24 V	CW input (+24 V)
34	CCW+24 V	CCW input (+24 V)
35	CCW+	CCW input (+5 V)
36	CCW–	

* The signal will become effective if the applicable setting has been changed using the **MEXE02** or the **OPX-2A**.

Internal input circuit

All input signals of the driver are photocoupler inputs. The signal state represents the "ON: Carrying current" or "OFF: Not carrying current" state of the internal photocoupler rather than the voltage level of the signal.

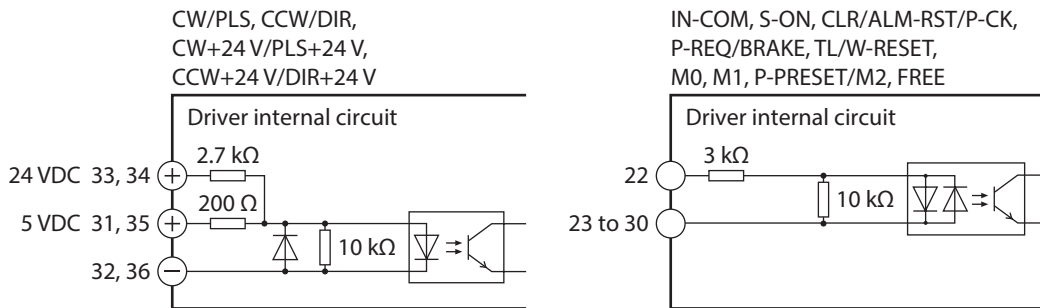

Internal output circuit

The driver outputs signals in the photocoupler/open-collector output mode and the line driver output mode. The signal state represents the "ON: Carrying current" or "OFF: Not carrying current" state of the internal photocoupler rather than the voltage level of the signal.

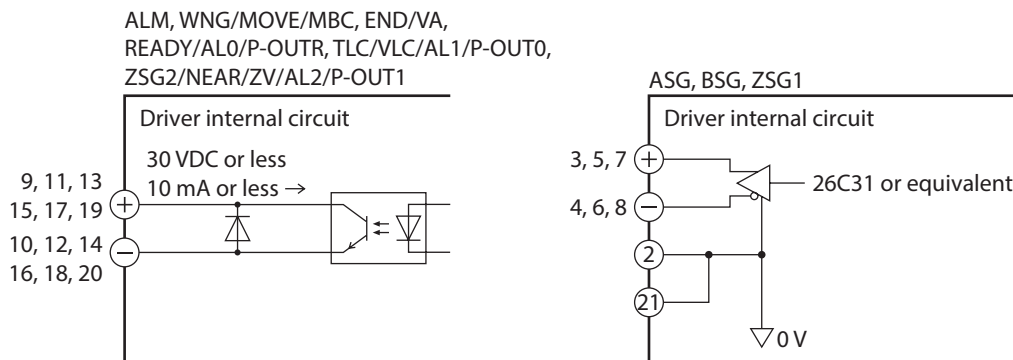

memo The ASG output, BSG output and ZSG1 output are line driver outputs. When connecting a line driver output, receive it with a line receiver. Also, be sure to connect pin No.2 or No.21 on the driver to the GND on the line receiver, and connect a terminal resistor of 100 Ω or more between the driver and the input of the line receiver.

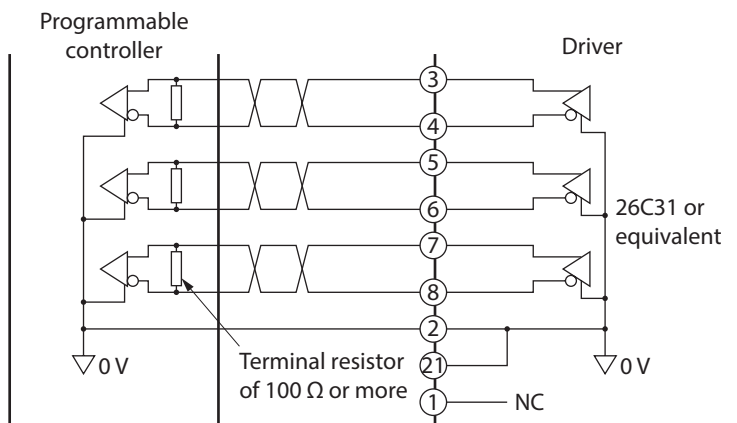

■ Connecting to a current sink output circuit

- When pulse input is of line driver type

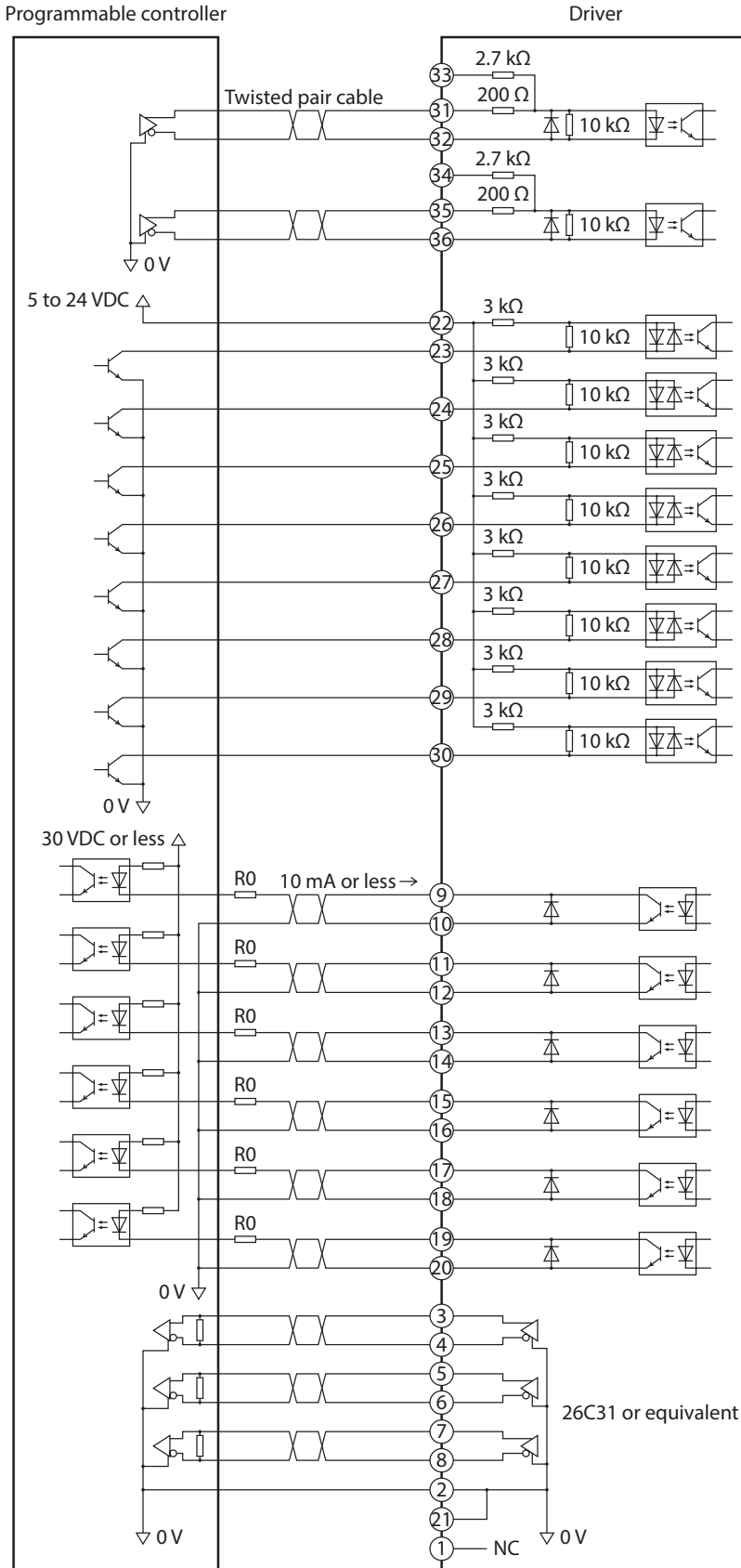

- Use output signals at 30 VDC or less. If the current exceeds 10 mA, connect an external resistor R0.
- Connect a terminal resistor of 100 Ω or more between the driver and the input of the line receiver.

- When pulse input is of open-collector type (input voltage 5 VDC)

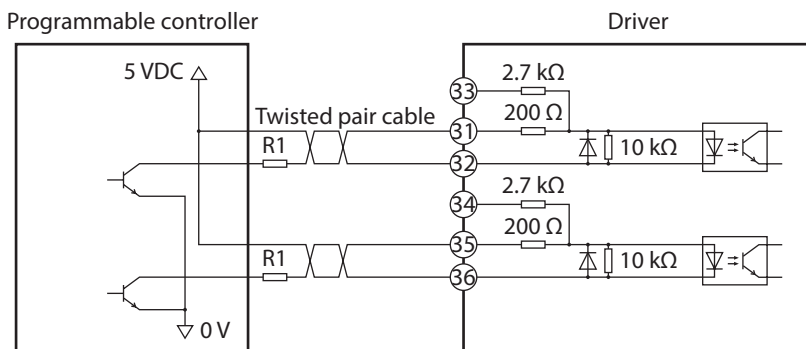

memo When using signals at 12 VDC, connect an external resistor R1 (1 kΩ, 0.25 W or more) so that the current becomes 20 mA or less.

- When pulse input is of open-collector type (input voltage 24 VDC)

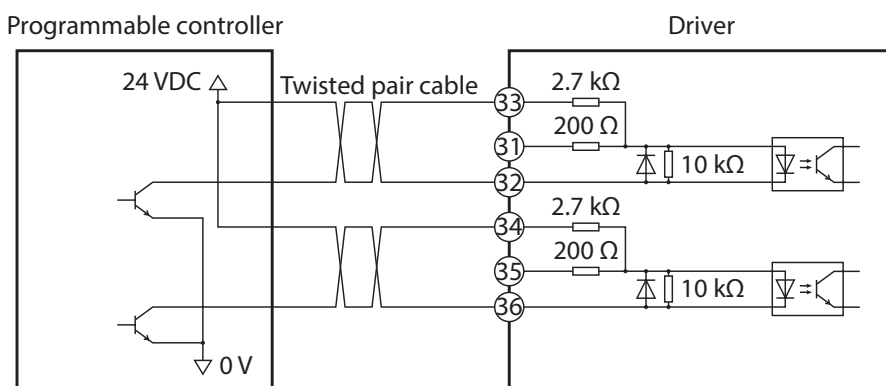

■ Connecting to a current source output circuit

- When pulse input is of line driver type

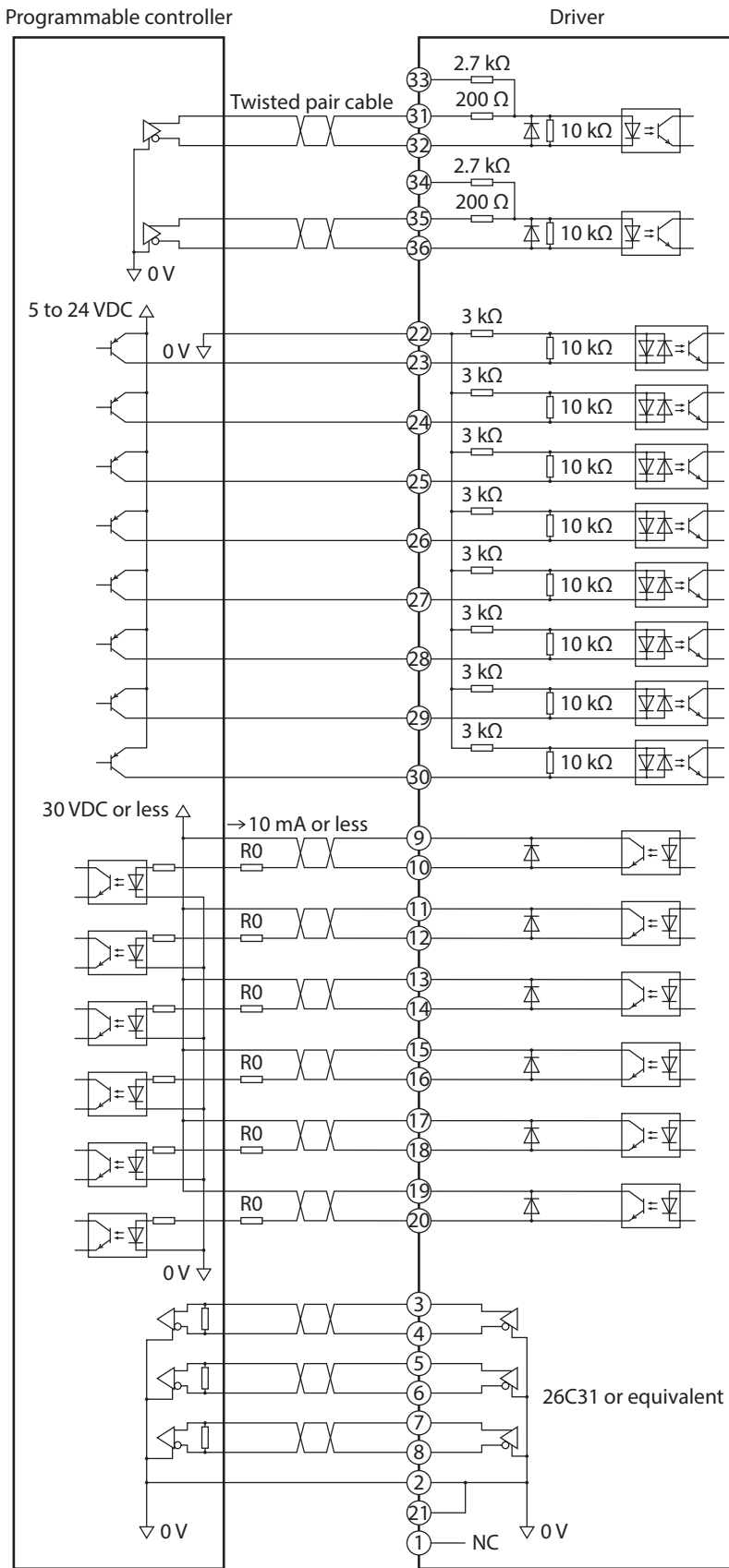

- Use output signals at 30 VDC or less. If the current exceeds 10 mA, connect an external resistor R0.
- Connect a terminal resistor of 100 Ω or more between the driver and the input of the line receiver.

- When pulse input is of open-collector type (input voltage 5 VDC)

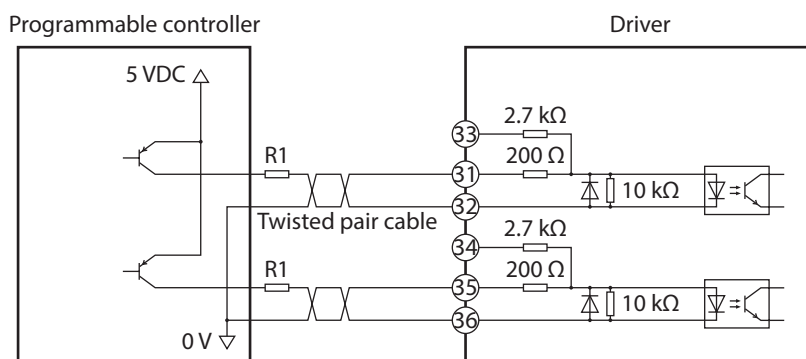

memo When using signals at 12 VDC, connect an external resistor R1 (1 kΩ, 0.25 W or more) so that the current becomes 20 mA or less.

- When pulse input is of open-collector type (input voltage 24 VDC)

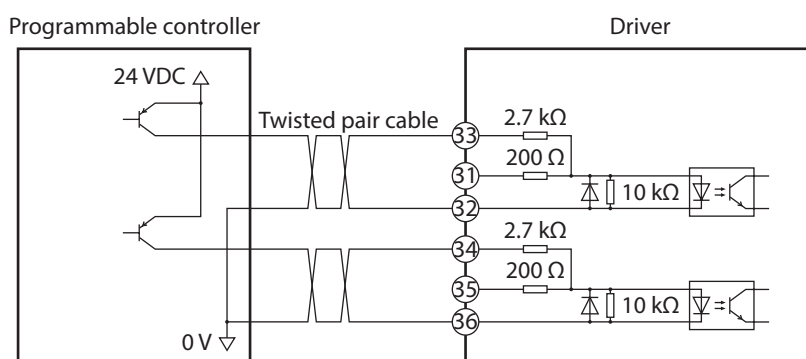

2-4 Connecting the analog I/O signals

Use the connector (20 pins) included in our accessory set **AS-SV2** or **AS-SD1** as the analog I/O connector (CN6).

Solder the analog I/O cable (AWG28 to 24: 0.08 to 0.2 mm²) to the CN6 connector by checking the pin numbers in "Connector function table" provided below. Use a shielded cable for analog I/O signals. Refer to p.44 for wiring the connectors.

We provide an driver cable allowing simple and easy connection with a driver, as well as the connector-terminal block conversion unit. Check the model names on p.220.

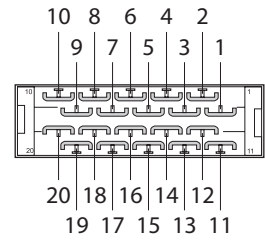

■ Connector function table

Pin No.	I/O	Signal name	Name	Description
1	Input	V-REF	Analog speed (command/limit) input	Terminal used to input an analog speed (command/limit).
2	GND	SG	Signal ground	Ground for analog I/O signals.
3	Output	P-VREF	Reference voltage output for analog speed (command/limit) input	A power supply output used to connect a variable resistor to the analog speed (command/limit) input.
4	Output	P-TREF	Reference voltage output for analog torque (command/limit) input	Power supply output used to connect a variable resistor to the analog torque (command/limit) input.
5	Input	T-REF	Analog torque (command/limit) input	Terminal used to input an analog torque (command/limit).
6	GND	SG	Signal ground	Ground for analog I/O signals.
7	Output	V-MON	Analog speed monitor output	Voltage corresponding to the monitored analog speed is output from here.
8	GND	SG	Signal ground	Ground for analog I/O signals.
9	Output	T-MON	Analog torque monitor output	Voltage corresponding to the monitored analog torque is output from here.
10	GND	SG	Signal ground	Ground for analog I/O signals.
11	-	-	-	-
12	-	-	-	-
13	-	-	-	-
14	-	-	-	-
15	-	-	-	-
16	-	-	-	-
17	-	-	-	-
18	-	-	-	-
19	-	-	-	-
20	-	-	-	-

■ Connecting the connector (CN6)

Insert the CN6 connector into the analog I/O connector (CN6) on the driver, and tighten the screws. The tightening torque of a screw varies depending on the manufacturer of the connector. Check the manufacturer and tightening torque of the connector before tightening the screw. Check the manufacturer name with the connector case.

Manufacturer of connector	Tightening torque [N·m (oz·in)]
3M Company	0.15 to 0.25 (21 to 35)
Molex Incorporated	0.3 to 0.35 (42 to 49)

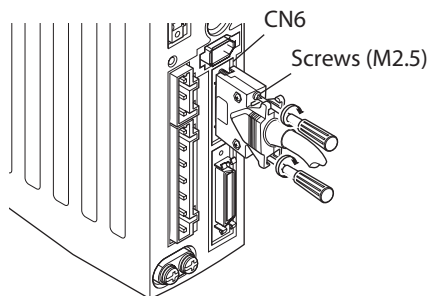

■ Connection example

● Input circuit

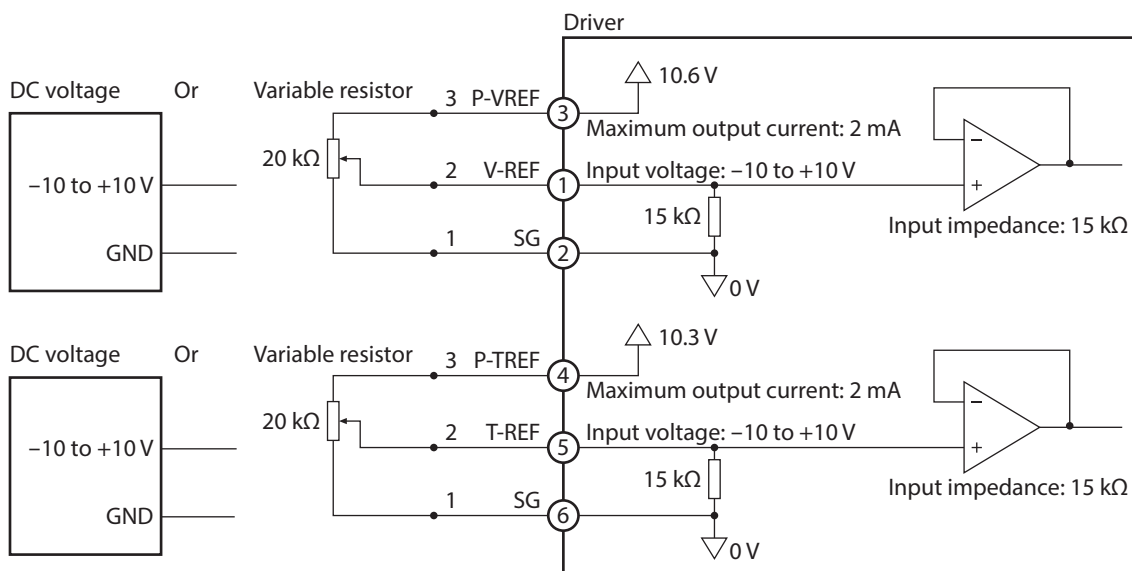

● Output circuit

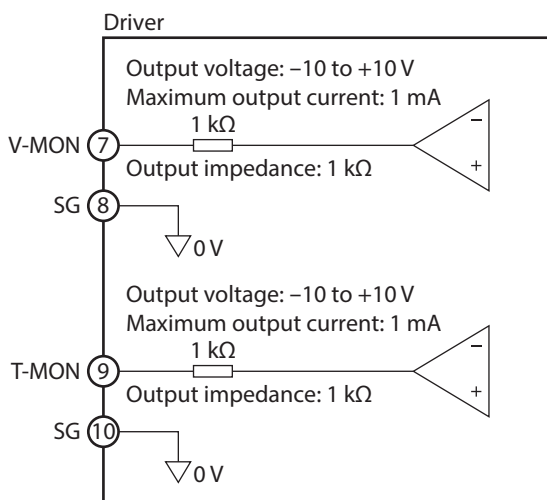

The output impedance is 1 kΩ. Check the input impedance of the measuring instrument or external circuit to be connected.

2-5 Connecting the power supply

Use the CN3 connector (7 pins) to connect the power supply cable (AWG16 to 14: 1.25 to 2.0 mm²) to the main power supply connector (CN3) on the driver. Refer to p.44 for details on the connector wiring method. Use a power supply capable of supplying the current capacity as below table.

- Note**
- Do not wire the power supply cable of the driver in the same cable duct with other power line or motor cable. Doing so may cause malfunction due to noise.
 - When connecting or disconnecting the CN3 connector, turn off the power and wait for the CHARGE LED to turn off before doing so. The residual voltage may cause electric shock.

memo The current capacity of the power supply as shown below is the value when operating the motor in the continuous duty region. When operating in the limited duty region, the current will flow maximum three times as much as the continuous region. Refer to p.236 for the continuous duty region and limited duty region.

■ Single-phase 100-115 V

Connect the live side of the power cable to the L terminal and the neutral side to the N terminal. Use a power supply capable of supplying the current capacity as shown below.

Model	Current capacity
NX45	1.9 A or more
NX410	2.9 A or more
NX65	1.9 A or more
NX610	2.9 A or more
NX620	4.6 A or more
NX810	2.8 A or more
NX820 NX920	4.6 A or more

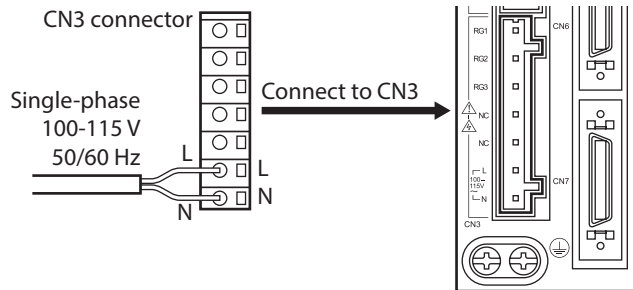

■ Single-phase 200-230 V

Connect the live side of the power cable to the L1 terminal and the neutral side to the L2 terminal. Use a power supply capable of supplying the current capacity as shown below.

Model	Current capacity
NX45	1.2 A or more
NX410	1.8 A or more
NX65	1.2 A or more
NX610	1.8 A or more
NX620	2.8 A or more
NX810	1.8 A or more
NX820 NX920	2.8 A or more

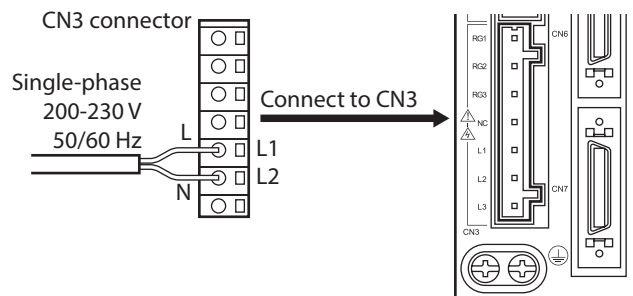

■ Three-phase 200-230 V

Connect the R, S and T phase lines of the power cable to the L1, L2 and L3 terminals, respectively. Use a power supply capable of supplying the current capacity as shown below.

Model	Current capacity
NX45	0.7 A or more
NX410	1.0 A or more
NX65	0.7 A or more
NX610	1.0 A or more
NX620	1.6 A or more
NX640	2.8 A or more
NX810	1.0 A or more
NX820 NX920	1.6 A or more
NX940	2.8 A or more
NX975	4.7 A or more
NX1040	2.9 A or more
NX1075	4.7 A or more

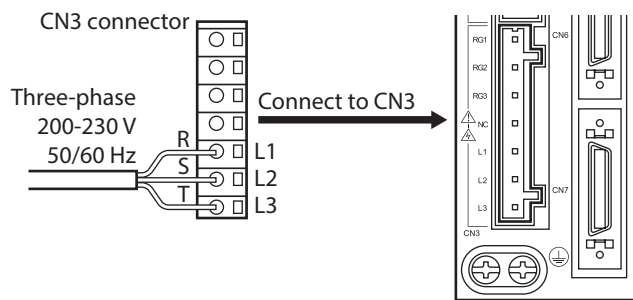

2-6 Grounding the driver

Two Protective Earth Terminals (nominal size: M4) are provided on the driver. Be sure to ground one of the Protective Earth Terminals.

- Grounding wire: AWG16 to 14 (1.25 to 2.0 mm²)
- Tightening torque: 1.2 N·m (170 oz·in)

Connect the Protective Earth wire of the cable for motor to a terminal that is not grounded.

When grounding the Protective Earth Terminal, use a round terminal and secure the grounding point near the driver. Do not share the grounding wire with a welder or any other power equipment.

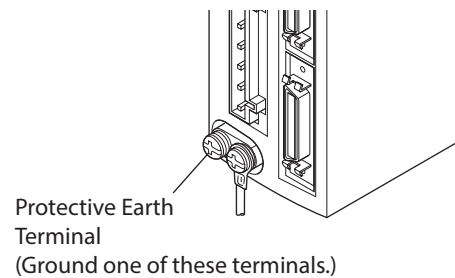

2-7 Connecting the 24 VDC power supply input, regeneration resistor and electromagnetic brake

Use the CN1 connector (6 pins) to connect the 24 VDC power supply input, regeneration resistor thermal input and electromagnetic brake. Connect the lead wire (AWG28 to 16: 0.08 to 1.25 mm²) to the connector while checking in the table. Refer to p.44 for wiring method.

Display	Description
24V+	24 VDC power supply input (Be sure to connect these terminals when an electromagnetic brake is used.)
24V-	
TH1	Regeneration resistor thermal inputs (If these terminals are not used, short them using a jumper wire.)
TH2	
MB1	Electromagnetic brake – (Connect the black lead wire of the electromagnetic brake.)
MB2	Electromagnetic brake + (Connect the white lead wire of the electromagnetic brake.)

■ Connecting the connector (CN1)

Nominal size: M2.5
Tightening torque: 0.4 N·m (56 oz·in)

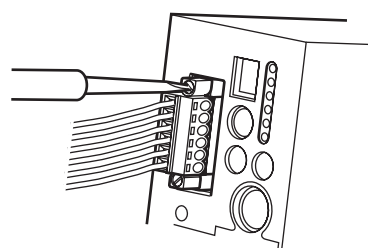

■ Connecting the 24 VDC power supply input

If the 24 VDC power supply is connected, alarm contents can be checked even when the main power supply is shut off by an alarm generation.

Since the 24 VDC power supply is not used for operating the motor, connect it as necessary.

When the electromagnetic brake motor is used, be sure to connect the 24 VDC power supply of the following capacity.

Model	Voltage	Current capacity	
		Standard	With electromagnetic brake
NX45, NX410, NX65, NX610, NX620, NX640, NX810, NX820, NX920, NX940	24 VDC±10 %	0.4 A or more	0.7 A or more
NX975, NX1040, NX1075			0.8 A or more

■ Connecting the regeneration resistor

● When the internal regeneration resistor is used

The driver has an internal regeneration resistor. The driver is shipped with the TH1 and TH2 terminals of CN1, and RG2 and RG3 terminals of CN3, shorted respectively to enable the internal regeneration resistor.

The internal regeneration resistor does not support continuous regenerative operation, gravitational operation or other operations involving up/down movements, or frequent repeating of sudden starting/stopping of a large inertial load. If any of these operations must be performed, use our regeneration resistor.

● When our regeneration resistor is used

- The two thin lead wires [AWG22 (0.3 mm²) for **RGB100**, AWG20 (0.5 mm²) for **RGB200**] of the regeneration resistor are thermostat outputs. Connect them to the TH1 and TH2 terminals using the CN1 connector.
- Regenerative current flows through the two thick lead wires (AWG18: 0.75 mm²) of the regeneration resistor. Remove from the CN3 connector the jumper wire which has shorted the RG2 and RG3 terminals, and connect the lead wires to the RG1 and RG3 terminals.

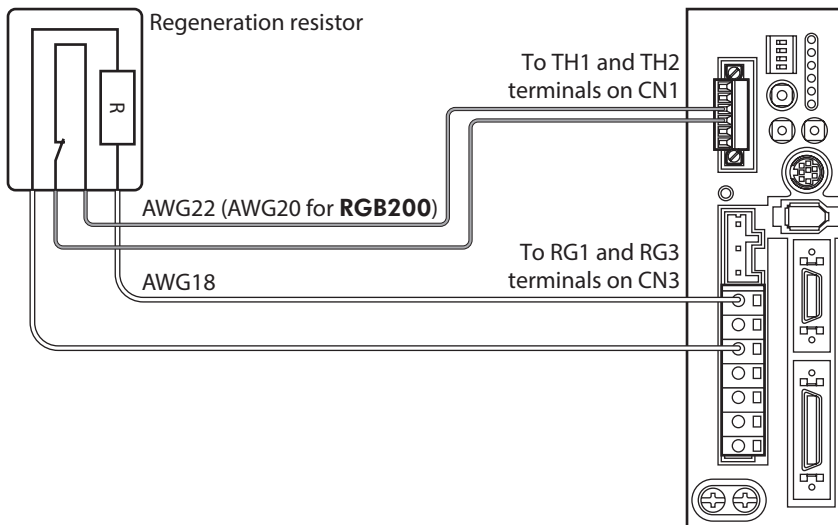

- When connecting our regeneration resistor, be sure to remove the jumper wires from the CN1 connector and CN3 connector.
- If the current consumption of the regeneration resistor exceeds the allowable level, the thermostat will be triggered and a regeneration resistor overheat alarm will generate. If a regeneration resistor overheat alarm generates, turn off the power and check the content of the error.

● Regeneration resistor specifications

NXD20-A, NXD20-C

Regeneration resistor type		Internal regeneration resistor	RGB100 *
Allowable current consumption	Continuous regenerative power	–	50 W
	Instantaneous regenerative power	600 W	600 W
Resistance		150 Ω	150 Ω
Operating temperature of thermostat		Operation: 95±5 °C (203±41 °F)	Operation: Opens at 150±7 °C (302±45 °F) Reset: Closes at 145±12 °C (293±54 °F) (normally closed)
Electrical rating of thermostat		–	120 VAC 4 A, 30 VDC 4 A (minimum current: 5 mA)

* Install the regeneration resistor in a location where heat dissipation capacity equivalent to a level achieved with a heat sink [made of aluminum, 350×350×3 mm (13.78×13.78×0.12 in.)] is ensured.

NXD75-S

Regeneration resistor type		Internal regeneration resistor	RGB200 *
Allowable current consumption	Continuous regenerative power	–	200 W
	Instantaneous regenerative power	2,250 W	2,250 W
Resistance		50 Ω	50 Ω
Operating temperature of thermostat		Operation: 75±5 °C (167±41 °F)	Operation: Opens at 175±5 °C (347±41 °F) Reset: Closes at 115±15 °C (239±59 °F) (normally closed)
Electrical rating of thermostat		–	227 VAC 8 A, 115 VAC 22 A

* Install the regeneration resistor in a location where heat dissipation capacity equivalent to a level achieved with a heat sink [made of aluminum, 350×350×3 mm (13.78×13.78×0.12 in.)] is ensured.

■ Connecting the electromagnetic brake

Refer to "2-2 Connecting the motor" on p.45.

2-8 Connecting the battery

1. Hold the driver with its bottom facing up and connect the connector attached at the end of the battery lead wires into the battery connector.
2. Hook the tabs on the battery connector onto the mating parts on the driver.
3. Push in the battery holder carefully by ensuring that the lead wires are not pinched.

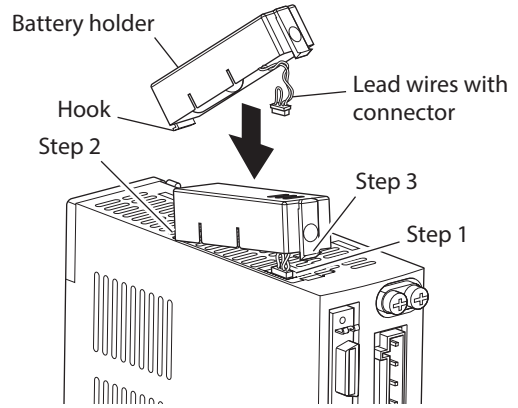

Note

- Installing or removing the battery must be performed by qualified personnel with expert knowledge of the handling of the driver and battery.
- Remove the battery if the driver is not turned on for an extended period exceeding the data retention period. Failure to do so may cause the battery fluid to leak or battery performance to drop.
- When installing or removing the battery, cut off the main power supply and 24 VDC power supply of the driver.
- Once the battery is disconnected, the absolute motor position stored in the driver will be lost. After the battery has been installed, be sure to set the absolute motor position again.

Specifications

Battery type	Lithium thionyl chloride batteries
Nominal voltage (V)	3.6
Rated capacity (mAh)	1,700
Weight [kg (oz.)]	0.025 (0.882)
Life	Approximately 4 years *
Data retention period	2 years *
Ambient temperature	0 to +50 °C (+32 to +122 °F) (non-freezing)
Ambient humidity	85 % or below (non-condensing)
Storage/Transporting temperature	+5 to +35 °C (+41 to +95 °F) (non-freezing)
Storage/Transporting humidity	70 % or below (non-condensing)

* At an ambient temperature of 20 °C (68 °F)

2-9 Connecting the data setter

Connect our communication cable for the support software or the **OPX-2A** cable to the data edit connector (CN4) on the driver.

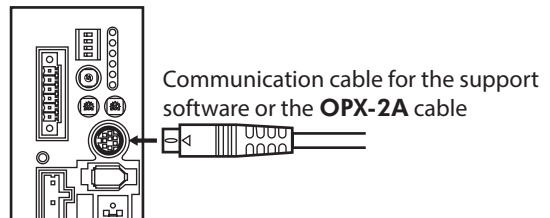

CAUTION

The data edit connector (CN4) and the analog I/O connector (CN6) on the driver are not electrically insulated. When grounding the positive terminal of the power supply, do not connect any equipment (PC, etc.) whose negative terminal is grounded. Doing so may cause the driver and these equipment to short, damaging both.

3 Position control mode

This part explains the functions and operation of the position control mode.

◆ Table of contents

1	Guidance	64	6	Current position output	82
2	List of setting items.....	66	6-1	Information that can be read	82
	2-1 Operation data	66	6-2	I/O signals used	83
	2-2 Application parameters.....	66	7	Gain tuning.....	84
	2-3 System parameters	68	7-1	Selecting the tuning mode	84
3	Positioning operation based on		7-2	Gain tuning mode	84
	pulse input.....	69	7-3	Gains that can be set with automatic	
4	Torque limit	76		tuning/semi-auto tuning	86
5	Absolute system	79	7-4	Method of gain tuning using the	
	5-1 Coordinate control range	79		MEXE02	87
	5-2 Loss of absolute position	79	8	Command filter	89
	5-3 Resetting the absolute position loss		9	Damping control.....	90
	alarm	80	9-1	Analog setting	91
			9-2	Digital setting.....	91

1 Guidance

The following functions are available in the position control mode:

- Positioning operation based on pulse input.....Positioning operation is performed based on input pulses.
- Torque limit.....The maximum output torque of the motor is limited.
- Absolute systemWhen a battery is connected, the absolute function of the driver can be used.
- Current position output.....The current position data recognized by the driver is output.
- Tuning.....Operations are performed via automatic tuning. Gain adjustment is also possible according to the load inertia or mechanical rigidity.
- Damping controlResidual vibration can be suppressed during positioning, in order to shorten the positioning time.

If you are new to the **NX** Series driver, read this section to understand the operating methods along with the operation flow.



Before operating the motor, check the condition of the surrounding area to ensure safety.

STEP 1 Check the installation and connection

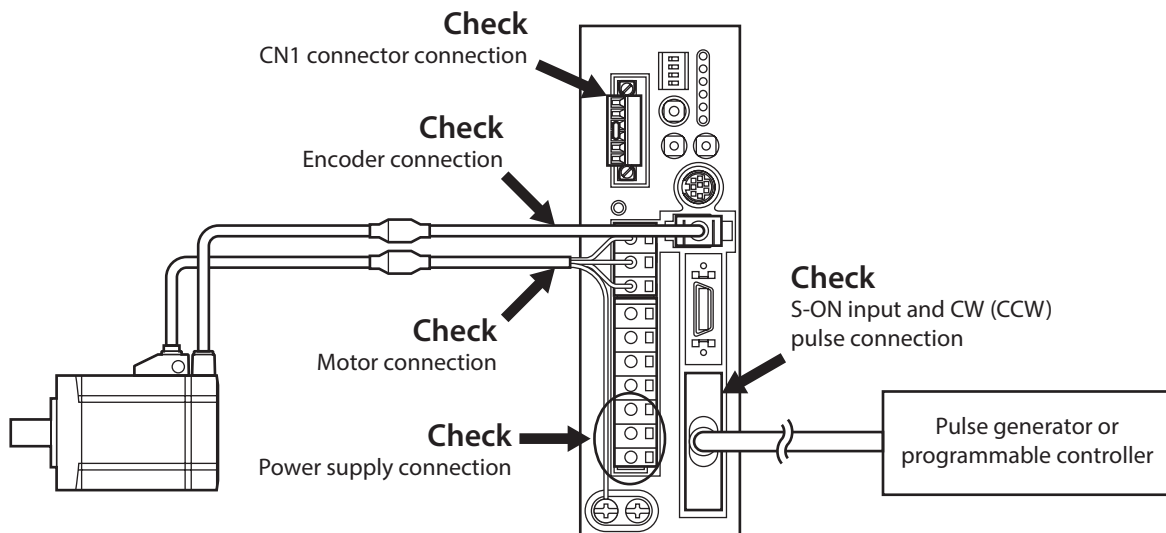

STEP 2 Operate the motor

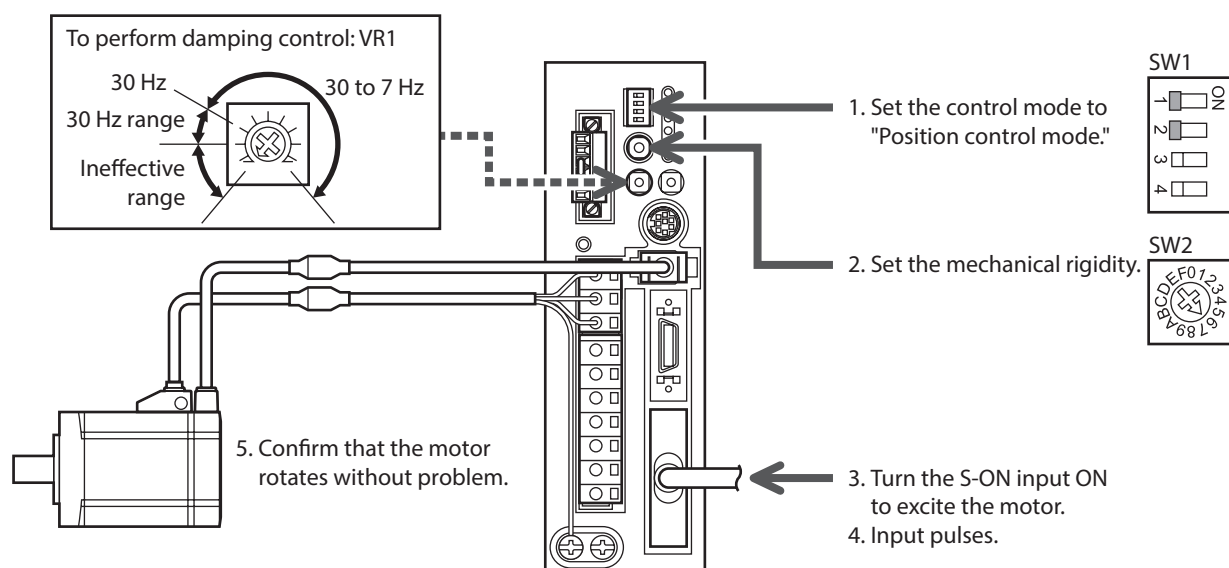

The new settings of the control mode setting switches will become effective after the power is turned on again. If a 24 VDC power supply is used, also turn on the 24 VDC power supply again.

STEP 3 Were you able to operate the motor properly?

How did it go? Were you able to operate the motor properly?

If the motor does not function, check the following points:

- Is the S-ON input ON?
- Are the thermal terminals for regeneration resistor (TH1 and TH2) on the CN1 (shorted)?
- Is any alarm present?
- Are the power supply and motor connected securely?
- Is the POS LED (green) lit?

For more detailed settings and functions, refer to the following pages.

2 List of setting items

The items that can be set in the position control mode are listed below.

You can use the **MEXE02** or the **OPX-2A** to set operation data or change the internal parameters of the driver.

2-1 Operation data

Item	Description	Setting range
Torque limit	Sets the torque limit value.	0 to 300 [%]
Damping frequency	Sets the damping control frequency.	7.00 to 100.00 [Hz]

2-2 Application parameters

MEXE02 tree view	Name	Description	Setting range
Gain	Gain tuning mode selection	Selects the gain tuning mode.	0: Automatic 1: Semi-auto 2: Manual
	Load inertial moment ratio	Sets the ratio of load inertial moment and motor inertial moment.	0 to 10,000 [%]
	Mechanical rigidity settings	Selects the rigidity applicable to automatic, semi-auto or manual tuning.	0 to 15
	Position loop gain	Sets the position loop gain. When this value is increased, the response will increase.	1 to 200 Hz
	Speed loop gain	Sets the speed loop gain. When this value is increased, the response will increase.	1 to 1,000 Hz
	Speed loop integral time constant	Sets the speed loop integral time constant. When this value is decreased, the response will increase.	1.0 to 500.0 [ms]
	Speed feed-forward ratio	Sets the speed feed-forward ratio. This parameter can be used to shorten the positioning time.	0 to 100 [%]
I/O	S-ON signal logic	Changes the S-ON input logic.	0: Normally open 1: Normally closed
	Output signal selection 1	Selects the output signal.	0: WNG output 1: MOVE output 2: MBC output
	Output signal selection 2	Selects the output signal.	0: ZSG2 output 1: NEAR output
	Positioning complete output band	Sets the output condition for END output.	0.01 to 36.00 [°]
	Positioning near output band	Sets the output condition for NEAR output.	0.01 to 36.00 [°]
	Minimum ON time for MOVE signal	Sets the minimum ON time for MOVE output.	0 to 255 [ms]
	Preset value	Sets the preset position.	-2,147,483,648 to 2,147,483,647 [step]
	Alarm code output	Changes the setting to enable/disable alarm code output.	0: Disable 1: Enable

MEXE02 tree view	Name	Description	Setting range
Analog	Analog torque limit gain	Sets the torque limit per 1 V of analog input voltage.	0 to 300 [%]
	Analog torque limit offset voltage	Sets the offset voltage for analog torque limit input.	-1.00 to 1.00 [V]
	Analog input signal automatic offset	Changes the setting to enable/disable automatic offset for analog input signals.	0: Disable 1: Enable
	Analog speed monitor maximum value	Sets the maximum value of monitored analog speed. This setting determines the slope of output of monitored analog speed.	1 to 6,000 [r/min]
	Analog speed monitor maximum voltage	Sets the monitored output voltage corresponding to the maximum value of monitored analog speed.	1 to 10 [V]
	Analog speed monitor offset voltage	Sets the offset voltage for monitored analog speed.	-1.00 to 1.00 [V]
	Analog torque monitor maximum value	Sets the maximum value of monitored analog torque. This setting determines the slope of output of monitored analog torque.	1 to 300 [%]
	Analog torque monitor maximum voltage	Sets the monitored output voltage corresponding to the maximum value of monitored analog torque.	1 to 10 [V]
	Analog torque monitor offset voltage	Sets the offset voltage for monitored analog torque.	-1.00 to 1.00 [V]
Alarm/warning	Excessive position deviation alarm	Sets the condition under which an excessive position deviation alarm generates, as an amount of rotation of the motor shaft.	1 to 1000 [rev]
	Excessive position deviation warning	Sets the condition under which an excessive position deviation warning generates, as an amount of rotation of the motor shaft.	1 to 1000 [rev]
	Overvoltage warning	Sets the voltage under which an overvoltage warning generates.	320 to 400 [V]
	Undervoltage warning	Sets the voltage under which an undervoltage warning generates.	120 to 280 [V]
	Overheat warning	Sets the temperature under which an overheat warning generates.	40 to 85 [°C]
	Overload warning	Sets the condition under which an overload warning generates.	1 to 100 [%]
	Overspeed warning	Sets the speed under which an overspeed warning generates.	1 to 6,000 [r/min]
Function	Mechanical rigidity setting switch	Changes the setting to enable/disable the mechanical rigidity setting switch (SW2) on the driver.	0: Disable 1: Enable
	Command filter	Sets the time constant for command filter.	0 to 100 [ms]
	Damping control	Changes the setting to enable/disable damping control.	0: Disable 1: Enable
	Deceleration rate of speed monitor	The deceleration rate can be set when the actual speed for the output shaft of the geared motor is monitored.	1.0 to 100.0
Manual operation and display	JOG operating speed	Sets the operating speed of JOG operation.	1 to 300 [r/min]
	Data setter speed display	Shows the speed on the OPX-2A with a sign or as an absolute value.	0: Signed 1: Absolute value
	Data setter edit	Sets whether it is possible to edit using the OPX-2A .	0: Disable 1: Enable

2-3 System parameters

MEXE02 tree view	Name	Description	Setting range
Electronic gear	Electronic gear A	Sets the denominator of electronic gear.	1 to 1,000
	Electronic gear B	Sets the numerator of electronic gear.	1 to 1,000
	Encoder output electronic gear A	Sets the denominator of the electronic gear for encoder output.	1 to 1,000
	Encoder output electronic gear B	Sets the numerator of the electronic gear for encoder output.	1 to 1,000
Operation	Pulse input mode	Selects the pulse input mode.	0: Setting by the pulse input mode selector switch 1: 2-pulse input mode, negative logic 2: 2-pulses input mode, positive logic 3: 1-pulse input mode, negative logic 4: 1-pulses input mode, positive logic 5: Phase difference mode, ×1 6: Phase difference mode, ×2 7: Phase difference mode, ×4
	Operation after absolute position loss alarm reset	Selects how the motor should operate after an absolute position loss alarm is reset.	0: Enable pulse input at the ON edge of the P-REQ input 1: Enable pulse input
	Analog input signals	Changes the setting to enable/disable the analog input signals.	0: Disable 1: Enable
	Motor rotation direction	Selects rotation direction of the motor.	0: +=CCW 1: +=CW
	Data-setter initial display	Selects the initial screen to be displayed when the OPX-2A starts communicating with the driver. If the selected item is not supported in the position control mode, the top screen of the monitor mode is displayed as the initial display.	0: Operating speed [r/min] 1: Position [steps] 2: Torque [%] 3: Estimated inertial moment ratio [%] 4: Operation number 5: Selected number 6: Tension [%] 7: Revolution counter [rev] 8: Roll diameter [mm] 9: Top screen of monitor mode

3 Positioning operation based on pulse input

Positioning operation is performed according to the operation data set with the programmable controller. Follow the steps below to perform positioning operation:

- Step 1 Setting the pulse input mode
- Step 2 Setting the resolution
- Step 3 Setting the motor rotation direction
- Step 4 Confirming the absolute system function
- Step 5 Performing the positioning operation

Step 1 Setting the pulse input mode

Set a desired pulse input mode of the driver according to the pulse output mode of the controller (pulse oscillator) used with the driver. The pulse input mode can be set using the pulse input mode selector switch (SW1-4) on the driver or applicable parameter.

- 1-pulse input mode
A pulse signal is input via the PLS input and the direction is selected using the DIR input.
- 2-pulse input mode
When a pulse signal is input via the CW input, the motor will rotate in forward direction. If a pulse signal is input via the CCW input, the motor will rotate in reverse direction.
- Phase difference input mode (set by a parameter)
The motor will rotate in forward direction when the CCW input phase is delayed by 90° relative to the CW input.
The motor will rotate in reverse direction when the CCW input phase is advanced by 90° relative to the CW input.

■ Using the switch

Use the pulse input mode selector switch (SW1-4) to set a desired mode.

ON: 1-pulse input mode, negative logic

OFF: 2-pulse input mode, negative logic

Each mode can only be set with a negative logic using the pulse input mode selector switch. To select a positive logic, set the applicable parameter using the **MEXE02** or the **OPX-2A**.



- The new setting of the pulse input mode selector switch will become effective after the power is turned on again. If a 24 VDC power supply is used, also turn on the 24 VDC power supply again.
- The factory setting depends on the destination country.

■ Using the parameter

The system parameter for pulse input mode is used to set the input mode.

Pulse input mode	Input pattern	Timing chart
1-pulse input mode	Positive logic	<p>PLS input: ON (downward pulse), OFF (baseline). Pulse width: 0.8 μs or more.</p> <p>DIR input: ON (high), OFF (low).</p> <p>Rotation direction: Forward rotation (DIR ON), Reverse rotation (DIR OFF).</p>
	Negative logic	<p>PLS input: ON (upward pulse), OFF (baseline). Pulse width: 0.8 μs or more.</p> <p>DIR input: ON (high), OFF (low).</p> <p>Rotation direction: Forward rotation (DIR ON), Reverse rotation (DIR OFF).</p>

Pulse input mode	Input pattern	Timing chart
2-pulse input mode	Positive logic	
	Negative logic (initial setting)	
Phase difference input mode	x1	
	x2	
	x4	

Whether to cause the motor to rotate in CW direction or CCW direction when a forward direction pulse is input can be set using the system parameter for motor rotation direction. Refer to p.71.

memo When a system parameter has been changed, the new setting will become effective after the power is turned on again. If a 24 VDC power supply is used, also turn on the 24 VDC power supply again.

■ Pulse signal

Input a pulse with sharp rising and falling edges as shown in the figures. The figure shows the voltage levels of pulse signals.

- 1-pulse input mode, 2-pulse input mode

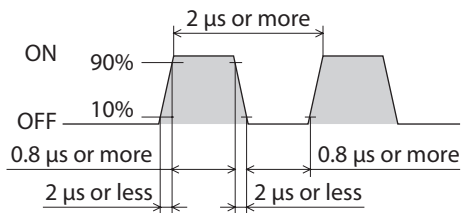

- Phase difference input mode

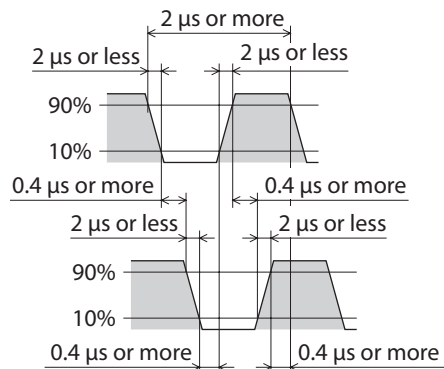

Step 2 Setting the resolution

Set the resolution using the system parameters for electronic gear A and electronic gear B. Note that the calculated value must fall within the setting range specified below:

Resolution setting range: 100 to 100,000 P/R

Factory setting: 1,000 P/R

$$\text{Resolution [P/R]} = 1,000 \times \frac{\text{Electronic gear B}}{\text{Electronic gear A}}$$

• Setting example

Resolution (P/R)	Electronic gear A	Electronic gear B
1,000	1 (initial value)	1 (initial value)
100	10	1
360	100	36



- When a system parameter has been changed, the new setting will become effective after the power is turned on again. If a 24 VDC power supply is used, also turn on the 24 VDC power supply again.
- If the calculated resolution exceeds the setting range, an electronic gear setting error warning will generate. Refer to p.207.
- If the power is turned on again while an electronic gear setting error warning is present, an electronic gear setting error alarm will generate. Refer to p.202.

Step 3 Setting the motor rotation direction

Set a desired motor rotation direction using the system parameter for motor rotation direction.

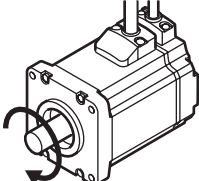
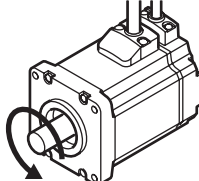
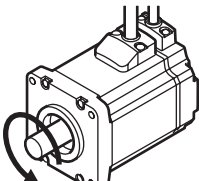
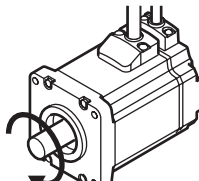

When a system parameter has been changed, the new setting will become effective after the power is turned on again. If a 24 VDC power supply is used, also turn on the 24 VDC power supply again.

Setting of motor rotation direction parameter	CW pulse is input	CCW pulse is input
When "1: +=CW" is set	The command position increases. The motor rotates in CW direction. 	The command position decreases. The motor rotates in CCW direction. 
When "0: +=CCW" is set	The command position increases. The motor rotates in CCW direction. 	The command position decreases. The motor rotates in CW direction. 

Step 4 Confirming the absolute system function

Install our battery **BAT01A**. When the battery is connected, the current position will be retained even in the event of power outage or after the driver power is cut off.

Set the absolute system function using the absolute system setting switch (SW1-3).

ON: Enable the absolute function

OFF: Disable the absolute function (factory setting)

For details, refer to "5 Absolute system" on p.79.



Step 5 Performing the positioning operation

1. Turn the S-ON input ON.
The motor is excited.
When the motor becomes ready, the READY output will turn ON.
2. Confirm that the READY output is ON, and input pulses.
The motor starts operating. The MOVE output remains ON while operation is in progress.
Once the motor operation ends and the rotor enters the positioning complete output band, the END output will turn ON.

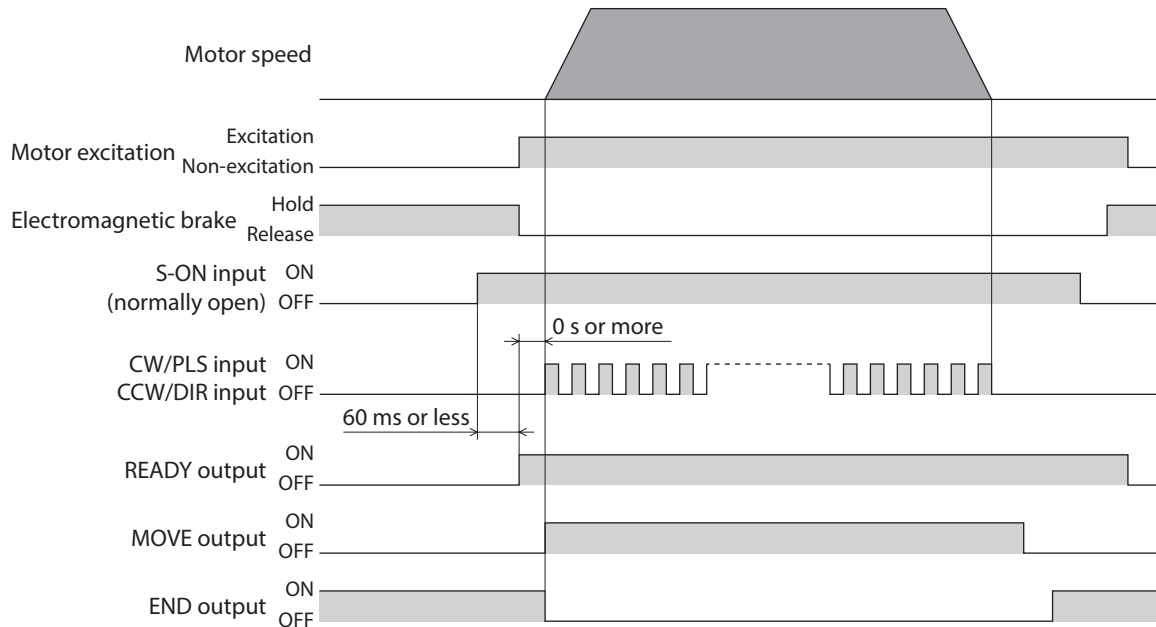

■ Exciting the motor: S-ON input

Turning the S-ON input ON will excite the motor.

In the case of an electromagnetic brake motor, the electromagnetic brake will be released after the motor is excited. When the S-ON input is OFF, the deviation counter will be cleared and input pulses will be ignored.

You can set the S-ON input to function in the contact A (normally open) or B (normally closed) logic using the application parameter for S-ON signal logic (the initial value is to use the contact A (normally open) logic). If the S-ON input is set to use the contact B (normally closed) logic, the motor will be excited automatically after the power is turned on and turning the S-ON input ON will cause the motor to lose its holding torque.



If the S-ON input is turned ON when only the 24 VDC power is input, a main power supply warning will generate. If a pulse signal is input while a main power supply warning is present, a main power supply error will generate.

■ Notifying that the motor is ready: READY output

When the motor becomes ready, the READY output will turn ON. Confirm that the READY output is ON before inputting pulses. The READY output remains ON while pulses are input.

The READY output is OFF under the following conditions. Motor operation is disabled while the READY output is OFF:

- The main power supply is cut off.
- An alarm is present.
- The S-ON input is OFF (the S-ON signal logic is "0: Contact A (normally open)")
- The FREE input or CLR input is ON.
- A remote operation is performed using **MEXE02**.
- An operation is performed on the **OPX-2A** in the test mode or copy mode.

■ Notifying that operation is in progress: MOVE output

The MOVE output can be enabled by selecting the output using the application parameter for output signal selection 1.

The MOVE output remains ON while the motor is operating. You can set the minimum time during which the MOVE output remains ON using the application parameter for minimum ON time for MOVE signal. Even in a short operation, the MOVE output will remain ON for the time set in this parameter.

Example: When 10 ms is set in the parameter for minimum ON time for MOVE signal.

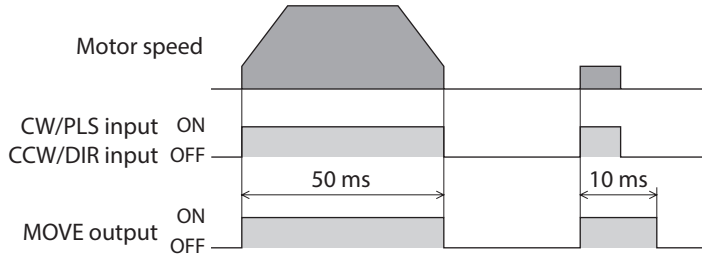

■ Notifying the completion of operation: END output

Once the motor operation ends and the position deviation falls within the positioning complete output band, the END output will turn ON. How long it takes for the END output to turn ON after the operation command completes varies depending on the operating conditions, etc.

You can set the band within which the END output turns ON, using the application parameter for positioning complete output band.

■ Notifying that the positioning target is near: NEAR output

The NEAR output can be enabled by selecting the output using the application parameter for output signal selection 2.

Once the motor operation ends and the position deviation falls within the positioning near output band, the NEAR output will turn ON.

You can set the band within which the NEAR output turns ON, using the application parameter for positioning near output band.

If the positioning near output band parameter is set to a value greater than the value in the END signal range, the NEAR output will turn ON before the END output does. This way, you can be informed that the positioning target is near.

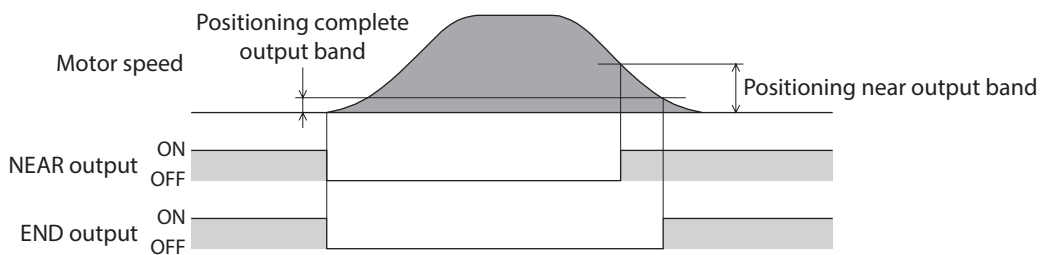

These outputs cannot be used in conjunction with the ZSG2 output.

■ Notifying the timing of electromagnetic brake control: MBC output

Use the MBC output to control the electromagnetic brake using a programmable controller, etc.

The MBC output can be enabled by selecting the output using the application parameter for output signal selection 1.

The MBC output will turn ON when the electromagnetic brake is released, and turn OFF when the electromagnetic brake is actuated (= to hold the load in position). Set the programmable controller to control the electromagnetic brake by detecting the ON/OFF status of the MBC output.

■ Clear the accumulated pulses (deviation) to zero: CLR input

When the CLR input is being ON, the pulses accumulated in the deviation counter (= deviation) will be cleared to zero. Input pulses are ignored while the CLR input is ON.

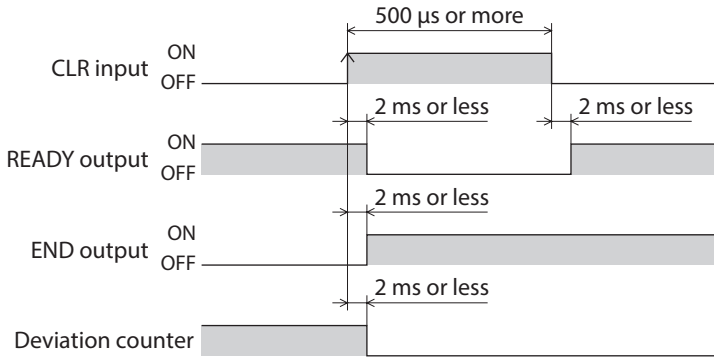

- memo**
- The CLR input functions as the P-CK input when the P-REQ input is ON. Accordingly, turning the CLR input ON while the P-REQ input is ON will not clear the deviation counter.
 - When an alarm generates, the CLR input changes to ALM-RST input. Take note that when the P-REQ input is ON, the function of the P-CK input is given priority and therefore turning ON the ALM-RST input will not reset the alarm.

■ Presetting the current position: P-PRESET input

When the P-PRESET input is turned ON, the value in the application parameter for preset value will be overwritten by the current position and the current position will become the home.

If the absolute function is enabled, turning the P-PRESET input ON will set the home. The preset value will be written to the non-volatile memory.

If the absolute function is disabled, the preset value is not written to the non-volatile memory. Accordingly, turning on the power supply again will reset the current position to zero.

If an absolute position loss alarm has generated, perform a return-to-home operation after resetting the alarm, and then set the home using the P-PRESET input.

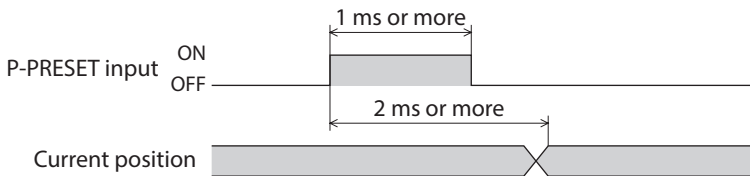

- Note** When the absolute function is enabled, do not turn off the main power and 24 VDC power for at least 5 seconds after the P-PRESET input has turned ON. If the power is turned off within 5 seconds, the preset value may not be reflected properly.

- memo** The non-volatile memory can be rewritten approximately 100,000 times.

■ Freeing the motor output shaft: FREE input

When the FREE input is turned ON, the motor current will be cut off. The motor will lose its holding torque, and the output shaft can be turned with an external force. The deviation counter will also be cleared.
 If the FREE input is turned ON while the position is held with the electromagnetic brake, the electromagnetic brake will be released. Accordingly, the position can no longer be held.

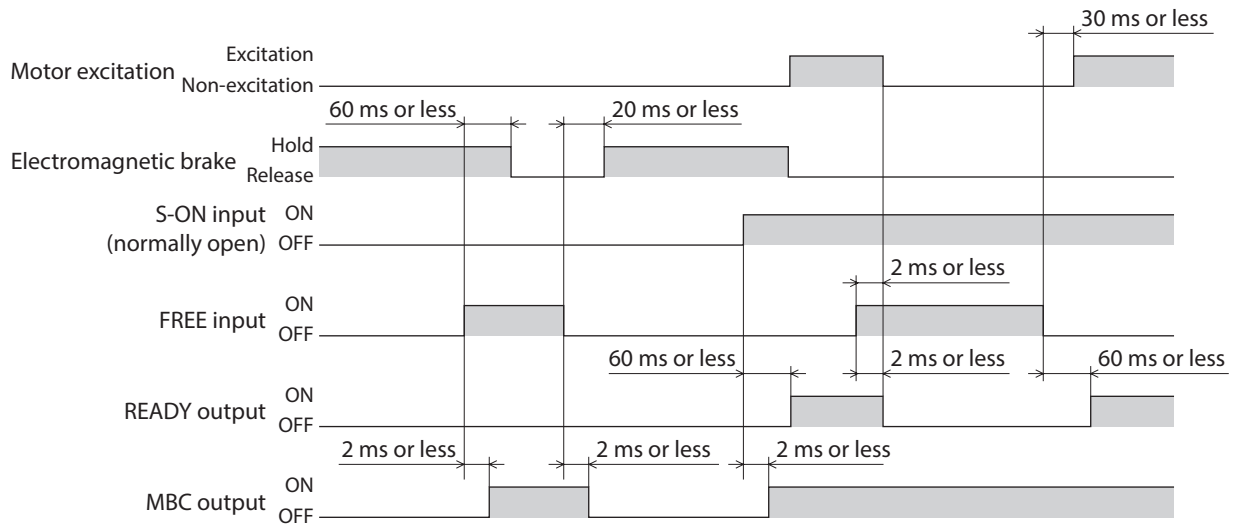

4 Torque limit

The maximum output torque of the motor can be limited by turning the TL input ON. Use this input to suppress motor torque, for your safety.

Follow the steps below to limit the maximum output torque of the motor during positioning operation:

Step 1 Setting the torque limit value

Step 2 Limiting the torque

Step 1 Setting the torque limit value

Set the torque limit value as an integer percentage of the rated torque being 100 % (*), under each of four operation data numbers from 0 to 3.

When the system parameter for analog input signals is set to "1: Enable," one analog point as well as three digital points are available to assign settings. If the parameter is set to "0: Disable," four digital points are available to assign settings.

* Set the value for geared motors based on the permissible torque being 100 %.

Operation data	Analog input signals	
	Enable (initial value)	Disable
No.0	Analog setting (External potentiometer or external DC voltage)	Digital setting
No.1	Digital setting	
No.2	Digital setting	
No.3	Digital setting	

memo One set of the torque limit and the damping frequency can be set in the operation data No.0 to No.3 each. Use by switching an operation data according to the operating condition. Select an operation data based on a combination of the ON/OFF status of the M0 and M1 inputs.

● Initial value

Operation data	Torque limit [%]	Damping frequency [Hz]
No.0 to No.3	0	30

● Data selection method

Operation data	M1 input	M0 input
No.0	OFF	OFF
No.1	OFF	ON
No.2	ON	OFF
No.3	ON	ON

■ Analog setting

1. Set the system parameter for analog input signals to "1: Enable."

memo When a system parameter has been changed, the new setting will become effective after the power is turned on again. If a 24 VDC power supply is used, also turn on the 24 VDC power supply again.

2. Turn the M0 and M1 inputs OFF and select operation data No.0.
3. Connect an external potentiometer or external DC voltage to pin No.4 to No.6 of the analog I/O connector (CN6). Refer to p.56 for details on the connection method.
4. Set the gain.
Set the torque limit value per 1 V of voltage command in the application parameter for analog torque limit gain.
Setting range: 0 to 300 %
Initial value: 30 %

5. Adjust the offset.

If there is even a slight margin of error in the voltage value, the torque limit value may not become 0 % even when the voltage command specifies 0 V (minimum value). In this case, adjust the offset using one of the two methods described below.

Automatic adjustment

- 1) Set the application parameter for Analog input signal automatic offset to "1: Enable."
- 2) Input 0 V to the analog input terminal (pin No.5 of CN6).
- 3) Apply the offset for analog torque input using the **MEXE02** or the **OPX-2A**.

Adjustment using a parameter

- 1) Set the application parameter for Analog input signal automatic offset to "0: Disable."
- 2) Set the offset voltage in the application parameter for analog torque limit offset voltage.

6. Use an external potentiometer or external DC voltage to set the torque limit value.

Setting example

Setting example	Analog torque limit gain	Analog torque limit offset voltage	Description
①	30 %	0 V	The torque limit value per 1 V of voltage command becomes 30 %.
②	10 %	0 V	The torque limit value per 1 V of voltage command becomes 10 %.
③	100 %	0 V	The torque limit value per 1 V of voltage command becomes 100 %.
④	30 %	1 V	The home of voltage command becomes 1 V. The gain of torque limit value is the same as in example ①.

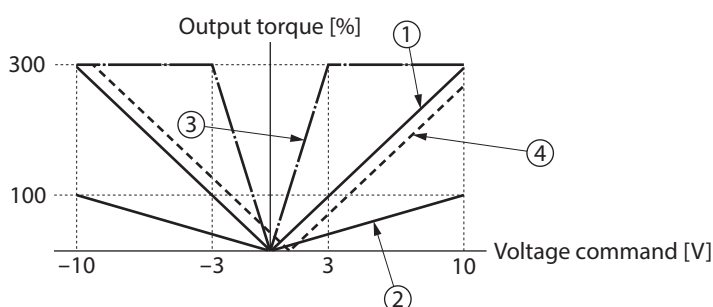
**■ Digital setting****● When the analog input signals parameter is set to "1: Enable"**

1. Set the system parameter for analog input signals to "1: Enable."

memo When a system parameter has been changed, the new setting will become effective after the power is turned on again. If a 24 VDC power supply is used, also turn on the 24 VDC power supply again.

2. Use the **MEXE02** or the **OPX-2A** to set one of operation data No.1 to No.3 as the torque limit value.
3. Select one of operation data No.1 to No.3 based on a combination of ON/OFF statuses of M0 and M1 inputs.

● When the analog input signals parameter is set to "0: Disable"

1. Set the system parameter for analog input signals to "0: Disable."

memo When a system parameter has been changed, the new setting will become effective after the power is turned on again. If a 24 VDC power supply is used, also turn on the 24 VDC power supply again.

2. Use the **MEXE02** or the **OPX-2A** to set one of operation data No.0 to No.3 as the torque limit value.
3. Select one of operation data No.0 to No.3 based on a combination of ON/OFF statuses of M0 and M1 inputs.

Step 2 Limiting the torque

Turning the TL input ON while positioning operation is in progress will limit the maximum output torque by the torque limit value you have set.

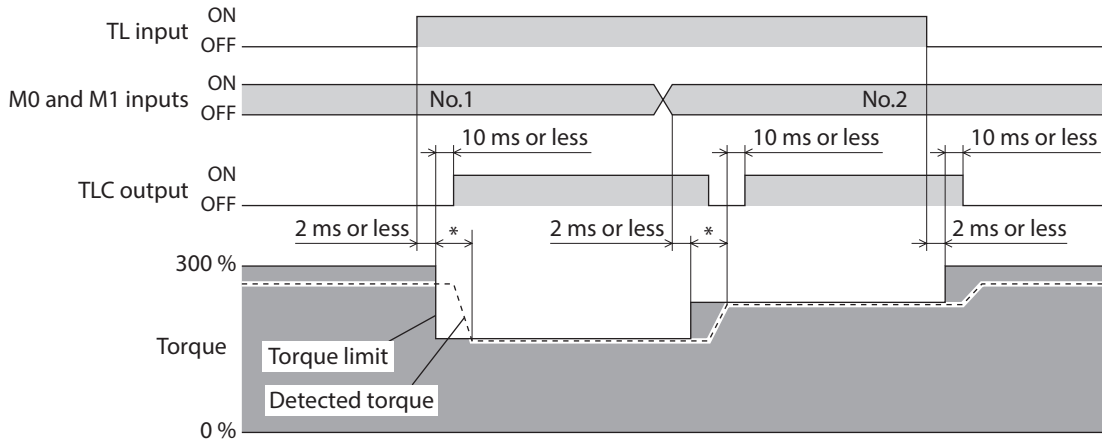

* The specific time varies depending on the load condition and gain.

Note When the maximum output torque of the motor is limited by the TL input, the motor may not rotate because of insufficient torque if a load is larger than the maximum output torque of the motor. If the TL input is turned OFF in this state, the maximum output torque of the motor will increase rapidly to cause unexpected movements of the moving part, leading to injury or damage to equipment.

■ Enabling the torque limit function: TL input

When the TL input is turned ON, the torque limit function will be enabled and the maximum output torque of the motor will be adjusted to the specified torque limit value.

While the TL input is OFF, the torque limit function is disabled and the maximum output torque of the motor remains 300 % (the rated torque corresponds to 100 %).

■ Notifying that the torque is being limited: TLC output

When the specified torque limit value is reached, the TLC output will turn ON.

5 Absolute system

Install our battery **BAT01A**. When the battery is connected, the current position will be retained even in the event of power outage or after the driver power is cut off. Set the absolute system function using the absolute system setting switch (SW1-3).
 ON: Enable the absolute function
 OFF: Disable the absolute function (factory setting)



- memo**
- If an absolute position loss alarm generates when the absolute function is enabled, the following causes are suspected. Reset the alarm by referring to “5-3 Resetting the absolute position loss alarm” on p.80.
 - The power was turned on for the first time after connecting the battery.
 - The battery was disconnected while the main power supply and 24 VDC power supply were cut off.
 - The battery voltage became low while the main power supply and 24 VDC power supply were cut off.
 - The encoder cable was disconnected.
 - The coordinate control range was exceeded. (In this condition, a position range error is output first. When the motor is operated again, an absolute position loss alarm will generate.)
 - If the absolute function is set to “1: Enable” but no battery is connected, a “no battery” alarm will generate.
 - If a battery is connected when the absolute function is set to “0: Disable,” an “ABS not supported” alarm will generate.
 - The new setting of the absolute system setting switch will become effective after the power is turned on again. If a 24 VDC power supply is used, also turn on the 24 VDC power supply again.
 - The factory setting of the absolute function is “OFF” (Disable). Accordingly, position information will be lost once the power is turned off.

5-1 Coordinate control range

The range of motor positions that can be controlled using the absolute system function corresponds to the smaller of the two ranges specified below. Which range is used varies depending on the motor resolution:

- Current position: $-2,147,483,648$ to $+2,147,483,647$ steps
- Amount of rotation: $-32,768$ to $+32,767$ revolutions

Note When the current position exceeds the coordinate control range, a position range error alarm will generate. Resetting the position range error alarm will cause an absolute position loss alarm to generate.

5-2 Loss of absolute position

If, when the absolute function is enabled, the position information stored in the driver is lost due to low battery voltage, etc., an absolute position loss alarm will generate. Reset the alarm by referring to “5-3 Resetting the absolute position loss alarm” on p.80.

You can set how to enable pulse input after an absolute position loss alarm has been reset. Set the method in the system parameter for operation after absolute position loss alarm reset.

Parameter for operation after absolute position loss alarm reset	Description
Enable pulse input at the ON edge of the P-REQ input (initial value)	Even after resetting the alarm with the ALM-RST input, pulse input will remain disabled until the P-REQ input is turned ON. If a pulse is input before the P-REQ input turns ON, an absolute position loss alarm will generate again.
Enable pulse input	Pulse input will be enabled once the alarm is reset with the ALM-RST input.

memo When a system parameter has been changed, the new setting will become effective after the power is turned on again. If a 24 VDC power supply is used, also turn on the 24 VDC power supply again.

5-3 Resetting the absolute position loss alarm

Be sure to set the home again after resetting the absolute position loss alarm. Turning on the power again without resetting the home will generate the absolute position loss alarm once again. The figure shows the timing chart for when the “Operation after absolute position loss alarm reset” parameter is set to “0: Enable pulse input at the ON edge of the P-REQ input.”

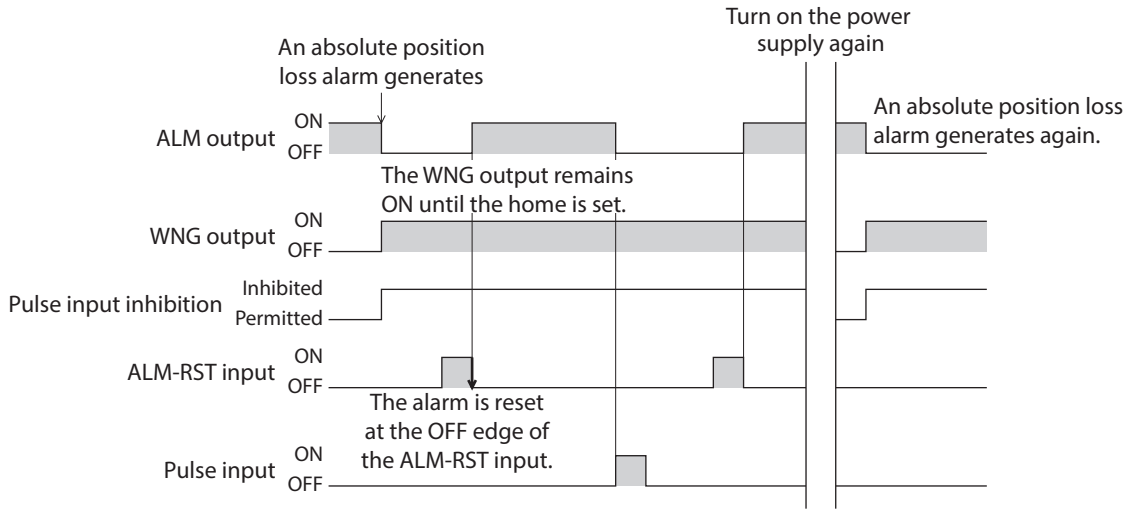

■ How to reset

1. Turn the ALM-RST input to ON and then OFF to reset the alarm.
2. Perform a return-to-home operation using a programmable controller.
3. Set the home again with the P-PRESET input.

Note

- Even after resetting the alarm, the alarm status will continue until the home is set again.
- Resetting the absolute position loss alarm will reset the current position to zero. As a result, performing a positioning operation before the home is set may cause the motor to move the equipment abruptly. Always set the home first.

● Procedure for when the home is set again after returning to the home

The figure shows an example to perform return-to-home operation after resetting an alarm and turning the P-REQ input ON.

The initial value of the "Operation after absolute position loss alarm reset" parameter is "0: Enable pulse input at the ON edge of the P-REQ input."

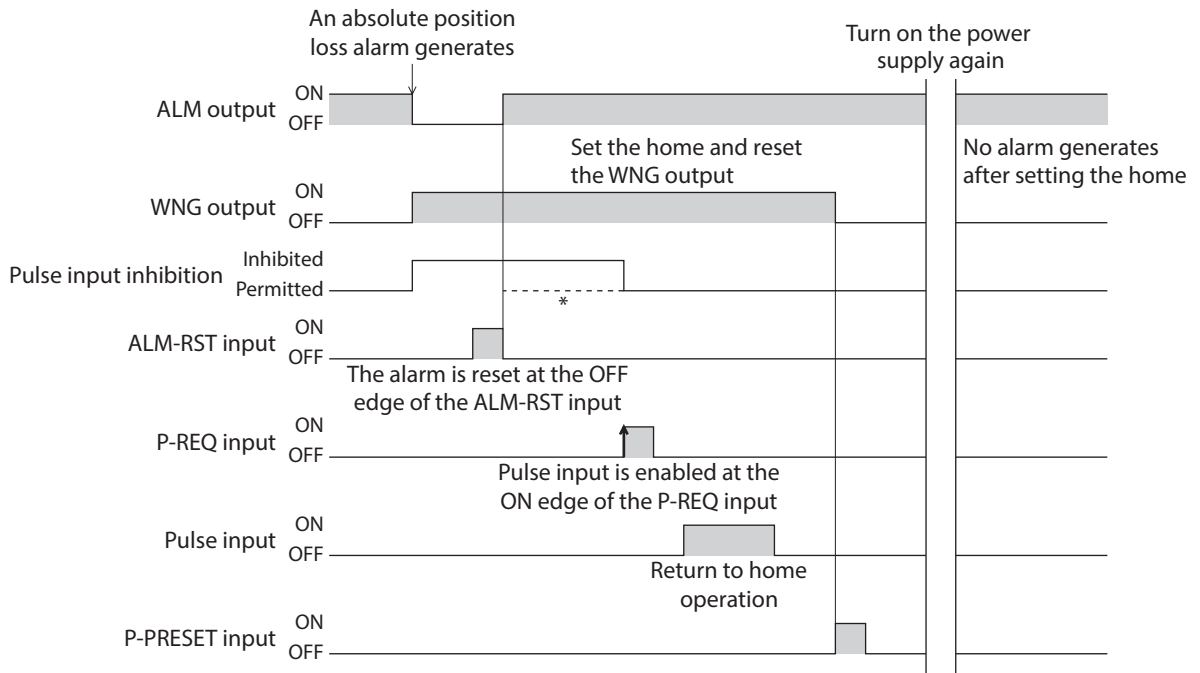

* The dashed line is when the "Operation after absolute position loss alarm reset" parameter is set to "1: Enable pulse input."



The P-REQ input can be used for the purpose of preventing malfunction. Setting the "Operation after absolute position loss alarm reset" parameter to "1: Enable pulse input" will allow pulse input without inputting the P-REQ input as shown by the dashed line. Select according to an operation.

● Procedure for when the home is set again without returning to the home

The figure shows an example to set the home again using the P-PRESET input after resetting an alarm.

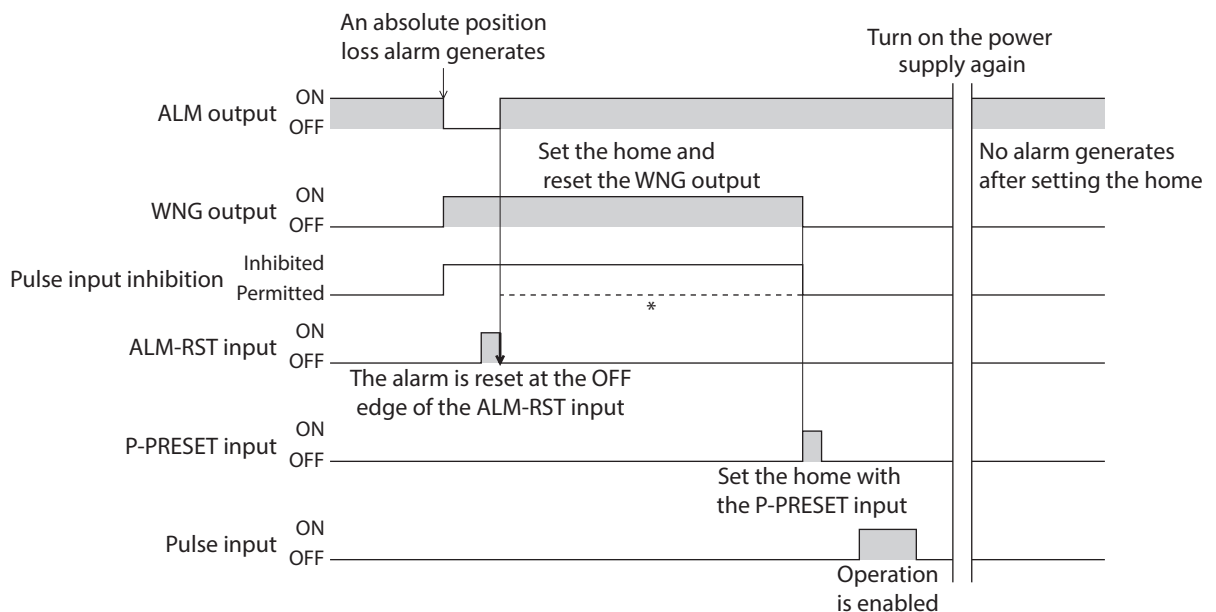

* The dashed line is when the "Operation after absolute position loss alarm reset" parameter is set to "1: Enable pulse input." Simply inputting the ALM-RST input will allow pulse input.

6 Current position output

This function can be used when the absolute system function is enabled. Current position data recognized by the driver is output. It takes 0.5 to 1 second to read the data.

The data is output as a 56 bits data signal consisting of the current position, status, alarm code and checksum. The data format is shown below.

The last 8 bits of the transmission data provide the checksum. They represent the last 8 bits of the result of adding the 48 bits consisting of the absolute data, status, and alarm code in one-byte units a total of six times.

6-1 Information that can be read

The information listed below can be read from the driver using this function. The driver outputs all information as binary values.



■ Current position (32 bits)

The first 32 bits are sent in binary mode, which is two's complement. When the current position is the positive value (+), the first 1 bit is "0." When the current position is the negative value (-), the first 1 bit is "1."

■ Status (8 bits)

These numbers indicate the driver status. Different information is assigned to each bit.

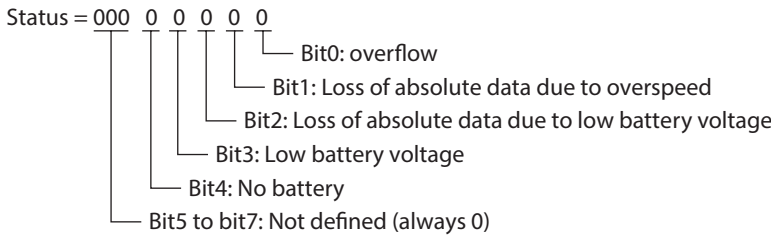

Example: When an overflow alarm has generated
Status = 0000 0001

■ Alarm code (8 bits)

8 bits are sent in binary mode.

Example: When an overload alarm has generated
Alarm code = 0011 0000 = 48 (decimal) = 30 (hexadecimal)

■ Checksum (8 bits)

The 48 bits of current position and status information are divided into bytes, and all bytes are added up. The checksum represents the last 8 bits in the result obtained by a total of six additions (addition of six bytes). This information is used to check if the data has been read correctly.

Example: Data output from the driver when the current position corresponds to 12,345 steps and an overload alarm is present

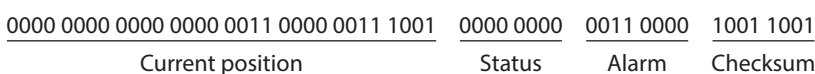

After the data has been read, all bytes constituting the current position (32 bits), status (8 bits) and alarm code (8 bits) read into the programmable controller are added up.

$$0000\ 0000 + 0000\ 0000 + 0011\ 0000 + 0011\ 1001 + 0000\ 0000 + 0011\ 0000$$

$$\text{Result} = 0000\ 0000\ \underline{1001\ 1001}$$

Last 8 bits (1 byte)

The checksum represents the last 8 bits, or “1101 0001” in the above example. If the calculated result matches the checksum value read from the driver, the data have been read correctly.

6-2 I/O signals used

The signals used in the current position output mode are indicated. This information is sent using two input signals and three output signals. Normally other signals are assigned to the P-CK input, P-OUTR output, P-OUT0 output and P-OUT1 output. When the P-REQ input turns ON, these signals function as the P-CK input, P-OUTR output, P-OUT0 output and P-OUT1 output. Note, however, that when the P-REQ input is ON, the current position output function is given priority. Accordingly, the CLR/ALM-RST input, READY/AL0 output, TLC/AL1 output and ZSG2/NEAR/AL2 output will not function.

Signal name	Description
P-REQ input	The programmable controller uses this signal to request the transmission of data.
P-CK input (normal: CLR/ALM-RST input)	This signal is used to request data (clock).
P-OUTR output (normal: READY output)	This signal indicates that data is ready for transmission.
P-OUT0 output (normal: TLC output) P-OUT1 output (normal: ZSG2/NEAR output)	These signals indicate two bits of data. The P-OUT0 output represents the low-order bit, while the P-OUT1 output represents the high-order bit.

The P-REQ input is always enabled. When the P-REQ input is ON during operation, the current position, status and alarm code are transmitted.

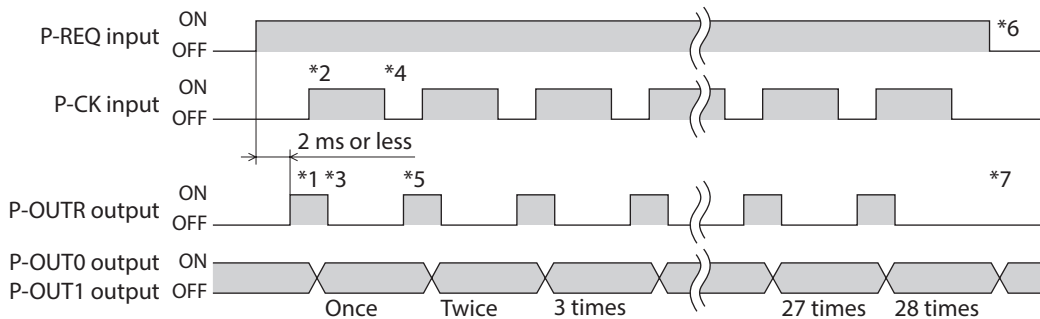

- *1 The driver turns the P-OUTR output ON within 2 ms of the ON edge of the P-REQ input.
- *2 The programmable controller turns the P-CK input ON after confirming that the P-OUTR output has turned ON.
- *3 After confirming that the P-CK input has turned ON, the driver sets upper 2 bits of the data to be sent in the P-OUT0 output and P-OUT1 output, and then turns the P-OUTR output OFF.
- *4 After confirming that the P-OUTR output has turned OFF, the programmable controller receives the P-OUT0 output and P-OUT1 output and then turns the P-CK input OFF.
- *5 The driver turns the P-OUTR output ON after confirming that the P-CK input has turned OFF. Steps *2 to *5 are repeated 28 times hereafter.
- *6 Once 56 bits of data have been received, the programmable controller turns the P-REQ input OFF.
- *7 The driver assigns the P-OUTR output to the READY output after confirming that the P-REQ input has turned OFF. If the P-REQ input turns OFF before the transmission is complete, the driver interrupts the transmission, assigns the signal again, and then turns the P-OUTR output OFF.

3 Position control mode

7 Gain tuning

The motor compliance with respect to commands can be adjusted according to the load inertia and mechanical rigidity.

You can also tune the motor in the semi-auto or manual mode in situations where the positioning time must be shortened, or when automatic tuning is difficult due to a large or fluctuating load inertial moment.

7-1 Selecting the tuning mode

Gain tuning can be performed in three modes. Select a desired tuning mode using the application parameter for gain tuning mode selection. Automatic tuning supports an adjustment range of up to 50 times the rotor inertia moment, while manual tuning supports an adjustment range of up to 100 times.

- Automatic:..... The load inertial moment is estimated internally by the driver. Simply set the mechanical rigidity and the gain will be adjusted automatically.
- Semi-auto:..... Set the mechanical rigidity and load inertial moment ratio, and the gain will be adjusted automatically.
- Manual:..... The customer must set the gain directly. Select this mode when the load inertia is large or the response needs to be increased above the level achievable by automatic tuning.

The parameters that can be set vary depending on the tuning mode.

MEXE02 tree view	Name	Automatic	Semi-auto	Manual
Gain	Load inertial moment ratio	–	○	○
	Mechanical rigidity setting	○	○	○
	Position loop gain	–	–	○
	Speed loop gain	–	–	○
	Speed loop integral time constant	–	–	○
	Speed feed-forward ratio	–	–	○

7-2 Gain tuning mode

■ Automatic

Set the mechanical rigidity using the mechanical rigidity setting switch (SW2) on the driver or the application parameter for mechanical rigidity setting.

Which value should be made effective is selected using the application parameter for mechanical rigidity setting switch.

Once the mechanical rigidity is set, the gain will be adjusted automatically.

Refer to p.86 for details on the range of gains that can be set with automatic tuning.

SW2 dial setting	"Value of mechanical rigidity setting switch" parameter	Reference mechanical rigidity
0 to 3	0 to 3	Low rigidity (belt pulley, etc.)
4 to 9	4 to 9	Medium rigidity (chain, etc.)
A to F	10 to 15	High rigidity (ball screw, directly coupled load, etc.)



The higher the value of mechanical rigidity, the higher the motor response becomes. Note, however, that an excessively high value may cause vibration or noise.



The estimated value of load inertial moment is saved in the driver's non-volatile memory every 20 minutes.

■ Semi-auto

1. Set the application parameter for load inertia moment ratio.
The load inertial moment ratio refers to the percentage of the inertial moment of the load to the rotor inertial moment of the motor. If the rotor inertial moment is equal to the load inertial moment, the load inertial moment ratio becomes 100 %. Refer to the catalog for the rotor inertial moment of your motor.
If the equipment is complex and estimating the load is difficult, you can use the **MEXE02** or the **OPX-2A** to monitor the load inertial moment ratio estimated by the driver.
2. Set the mechanical rigidity in the same manner as in the “automatic” mode.
Once the mechanical rigidity and load inertial moment ratio are set, the gain will be adjusted automatically. Refer to p.86 for details on the range of gains that can be set with semi-auto tuning.

■ Manual

Follow the procedure below to adjust the gain with a sufficient margin.

1. Set the application parameter for load inertia moment ratio.
The load inertial moment ratio refers to the percentage of the inertial moment of the load to the rotor inertial moment of the motor. If the rotor inertial moment is equal to the load inertial moment, the load inertial moment ratio becomes 100 %. Refer to the catalog for the rotor inertial moment of your motor.
If the equipment is complex and estimating the load is difficult, you can use the **MEXE02** or the **OPX-2A** to monitor the load inertial moment ratio estimated by the driver.
2. Set the mechanical rigidity in the same manner as in the “automatic” mode.
3. Adjust the compliance with respect to speed deviation. Set the application parameter for speed loop gain.
Increasing the speed loop gain will decrease the deviation between the command speed and actual speed. Note, however, that an excessively high value may increase the motor overshoot or cause hunting.
4. Decrease the deviation that cannot be adjusted with the speed loop gain. Set the application parameter for speed loop integral time constant.
If the integral time constant is too high, motor operation will become slow. If the constant is too low, on the other hand, hunting may occur.
5. Adjust the compliance with respect to position deviation. Set the application parameter for position loop gain.
Increasing the position loop gain will decrease the deviation between the command position and actual position. Note, however, that an excessively high value may increase the motor overshoot or cause hunting.
6. Repeat step 2 to step 5 to set an optimal gain.

■ Speed feed-forward ratio

If the speed is constant, the deviation between the command position and actual position can be reduced to shorten the settling time.

Setting the speed feed-forward ratio to 100 % will bring the deviation down to nearly 0. Note, however, that an excessively high value may increase the motor overshoot or undershoot.

7-3 Gains that can be set with automatic tuning/semi-auto tuning

In automatic tuning and semi-auto tuning, the gain is set automatically.
The table summarizes different conditions and corresponding gains.

SW2 dial setting	Value of mechanical rigidity setting switch parameter	Position loop gain [Hz]	Speed loop gain [Hz]	Speed loop integral time constant [ms]	Speed feed-forward ratio [%]
0	0	3	14	51.0	80
1	1	4	22	51.0	80
2	2	6	32	48.2	80
3	3	9	46	33.8	80
4	4	11	56	28.4	80
5	5	14	68	23.4	80
6	6	16	82	19.4	80
7	7	20	100	15.8	80
8	8	20	120	13.2	80
9	9	20	150	10.6	80
A	10	20	180	8.8	80
B	11	20	220	7.2	80
C	12	20	270	5.8	80
D	13	20	330	4.8	80
E	14	20	390	4.0	80
F	15	20	470	3.4	80

7-4 Method of gain tuning using the MEXE02

You can adjust parameters while checking the motor speeds and I/O signal status in waveforms.

1. Click the [Gain tuning] icon in the toolbar or click the [Gain tuning] short-cut button.
The gain tuning window appears.



2. Click "Start gain tuning."

The buttons in the window are enabled, allowing you to prepare for measurement of gain tuning.

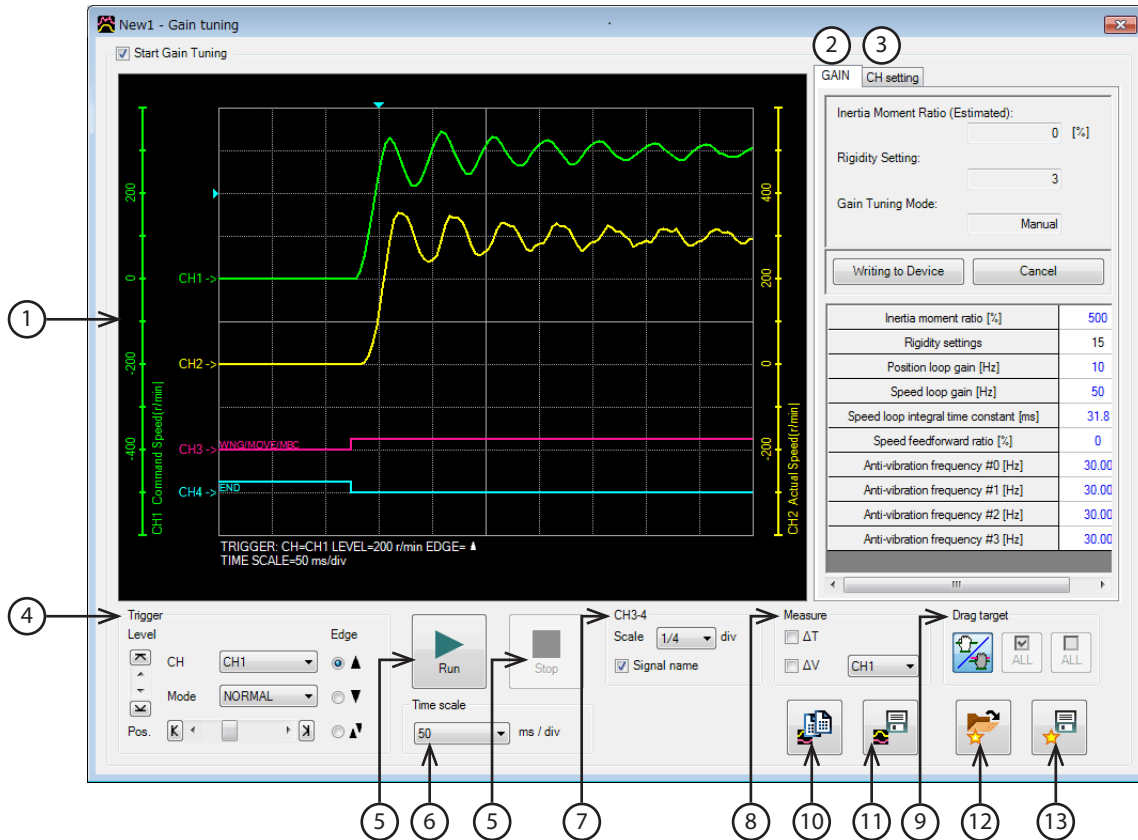

1	Measurement results are drawn in this area.
2	The settings of gain tuning can be specified.
3	The measurement conditions for each CH can be set.
4	Waveform measurement settings: Level, CH, Mode, Edge (detection condition), and Pos (trigger position) can be specified. For "CH," only those CHs displayed at ① can be specified.
5	Run: This button is used to start measurement. Stop: This button is used to stop measurement.
6	The measurement time range can be set.
7	The display method for CH3 and CH4 can be set. Scale: The display size can be selected from 1/1 (100 %), 1/2 (50 %), or 1/4 (25 %). Signal name: The signal name can be shown or hidden.
8	The measure for measurement can be shown or hidden. Also, the CH to be measured can be selected.
9	The display positions of waveforms drawn in the window can be moved. There are the following two moving methods. <ul style="list-style-type: none"> • Move the waveform per CH. • Move the waveform of the CH selected in ③ simultaneously.
10	The currently displayed waveform can be copied to the clipboard.
11	The currently displayed waveform can be saved to an external file.
12	The setting for measurement can be loaded from "favorites data."
13	The setting for measurement can be saved as "favorites data."

The gain tuning requires synchronization of the data under editing and the driver data. When the data is not synchronized, the following window appears. Select a synchronization method and click [OK].

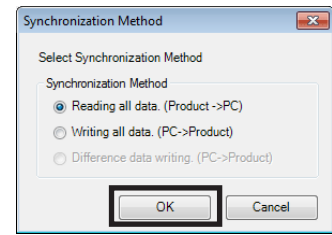

When the above window appears, all the communications in progress are disabled. All the other monitors in progress in other windows are also stopped. Resume monitor after synchronization is completed.

- Click the "CH setting" tab.
The measurement conditions for each CH can be set.

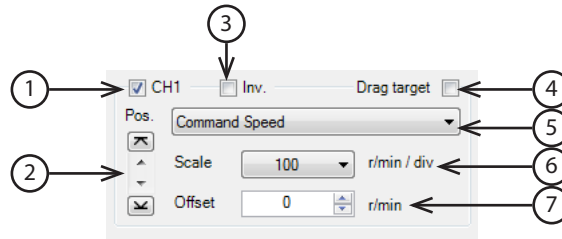

1	Each CH can be shown or hidden.
2	The display position of a waveform can be moved up or down.
3	The display of measured signal can be inverted.
4	Selecting this check box can drag displayed waveforms drawn in the window simultaneously.
5	This is used to select a signal to be measured.
6	This is used to select a display scale for signals (CH1 and CH2 only). Using this setting in combination with 7 can zoom in on signals.
7	The set offset value is added to the signal display (CH1 and CH2 only). Using this setting in combination with 6 can zoom in on signals.

- Click [Run].
The waveform measurement starts.
- During measurement, click [Stop] to exit the waveform measurement.
If "SINGLE" is selected for Mode in Trigger, measurement automatically ends when waveform drawing ends.
- Click the [GAIN] tab when adjusting the parameter while checking the status of the waveform.
- Click [Writing to device] after editing the parameter.
The changed parameter will be written to the driver.
- To exit the waveform measurement, unselect "Start gain tuning."

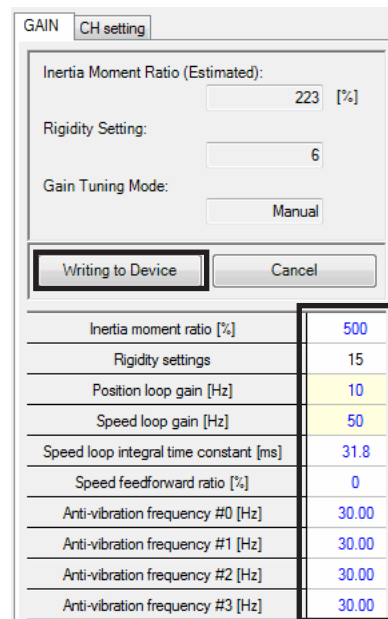

Parameter edit area

8 Command filter

You can apply a filter to the command position in order to make the acceleration/deceleration more gradual. Decreasing the value of command filter will shorten the settling time. However, an excessively low value may cause vibration. Set an appropriate value in the application parameter for command filter.

Initial value: 3 ms

• Command filter = 0 ms

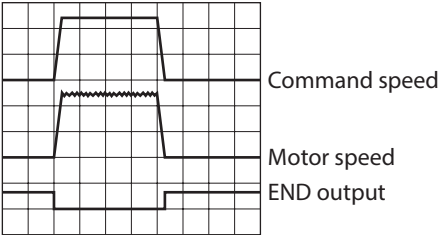

• Command filter = 100 ms

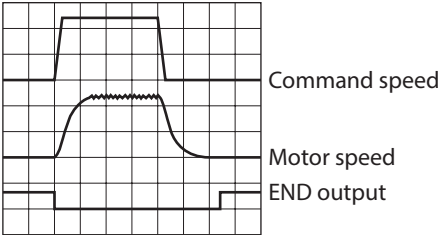

9 Damping control

Even if the motor is assembled into a machine of low rigidity, residual vibration can be reduced during positioning, in order to shorten the positioning time. (An optimal value varies depending on the equipment and its operating conditions.)

Set a damping control frequency under each of four operation data numbers from 0 to 3.

When the system parameter for analog input signals is set to "1: Enable," one analog point as well as three digital points are available to assign settings. If the parameter is set to "0: Disable," four digital points are available to assign settings.

Operation data	"Analog input signals" parameter	
	Enable (initial value)	Disable
No.0	Analog setting (internal potentiometer VR1)	Digital setting
No.1	Digital setting	
No.2	Digital setting	
No.3	Digital setting	



One set of the torque limit and the damping frequency can be set in the operation data No.0 to No.3 each. Use by switching an operation data according to the operating condition. Select an operation data based on a combination of the ON/OFF status of the M0 and M1 inputs.

- **Initial value**

Operation data	Torque limit [%]	Damping frequency [Hz]
No.0 to No.3	0	30

- **Data selection method**

Operation data	M1 input	M0 input
No.0	OFF	OFF
No.1	OFF	ON
No.2	ON	OFF
No.3	ON	ON

9-1 Analog setting

1. Set the system parameter for analog input signals to "1: Enable."

memo When a system parameter has been changed, the new setting will become effective after the power is turned on again. If a 24 VDC power supply is used, also turn on the 24 VDC power supply again.

2. Turn the M0 and M1 inputs OFF and select operation data No.0.
3. Use the internal potentiometer VR1 to set the damping control frequency.
The new damping control frequency becomes effective immediately, even when operation is in progress.
Setting range: 7.00 to 30.00 Hz
Factory setting: Disable
The damping control frequency set by the VR1 can be monitored in **MEXE02**.

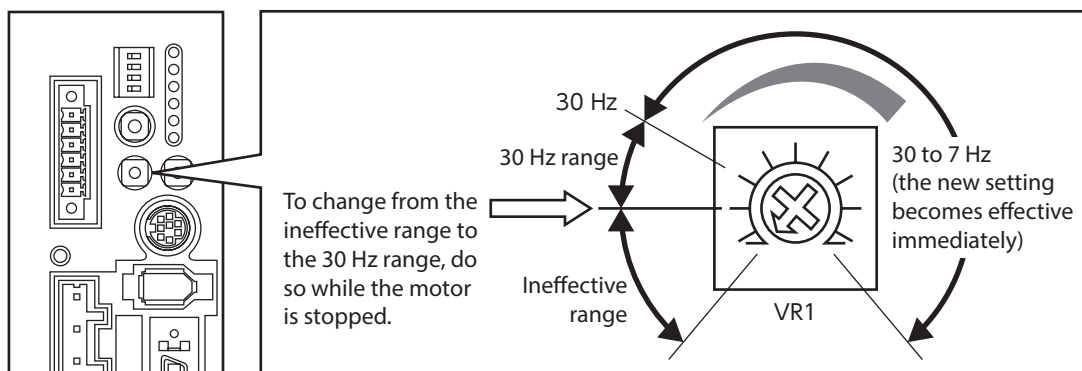

Note To change the damping control frequency from the ineffective range to the 30 Hz range, stop the motor before turning the VR1. Changing the setting while the motor is operating may cause the motor to move the equipment abruptly.

9-2 Digital setting

● When the analog input signals parameter is set to "1: Enable"

1. Set the system parameter for analog input signals to "1: Enable."

memo When a system parameter has been changed, the new setting will become effective after the power is turned on again. If a 24 VDC power supply is used, also turn on the 24 VDC power supply again.

2. Use the **MEXE02** or the **OPX-2A** to set one of operation data No.1 to No.3 as the damping control frequency.
Setting range: 7.00 to 100.00 Hz
Initial value: 30.00 Hz
3. Set the application parameter for damping control to "1: Enable."
4. Select one of operation data No.1 to No.3 based on a combination of ON/OFF statuses of M0 and M1 inputs.

● When the analog input signals parameter is set to "0: Disable"

1. Set the system parameter for analog input signals to "0: Disable."
2. Use the **MEXE02** or the **OPX-2A** to set one of operation data No.0 to No.3 as the damping control frequency.
Setting range: 7.00 to 100.00 Hz
Initial value: 30.00 Hz
3. Set the application parameter for damping control to "1: Enable."
4. Select one of operation data No.0 to No.3 based on a combination of ON/OFF statuses of M0 and M1 inputs.

4 Speed control mode

This part explains the functions and operation of the speed control mode.

◆ Table of contents

1	Guidance	94
2	List of setting items.....	96
	2-1 Operation data	96
	2-2 Application parameters.....	96
	2-3 System parameters	98
3	Speed control operation	99
4	Torque limit	108
5	Gain tuning	111
	5-1 Selecting the tuning mode	111
	5-2 Gain tuning mode	111
	5-3 Gains that can be set with automatic tuning/semi-auto tuning	113
	5-4 Method of gain tuning using the MEXE02	114

1 Guidance

The following functions are available in the speed control mode:

- Speed controlled operationThe motor speed is controlled.
- Torque limit.....The maximum output torque of the motor is limited.
- Tuning.....Operations are performed via automatic tuning. Gain adjustment is also possible according to the load inertia or mechanical rigidity.

If you are new to the **NX** Series driver, read this section to understand the operating methods along with the operation flow.

Note Before operating the motor, check the condition of the surrounding area to ensure safety.

STEP 1 Check the installation and connection

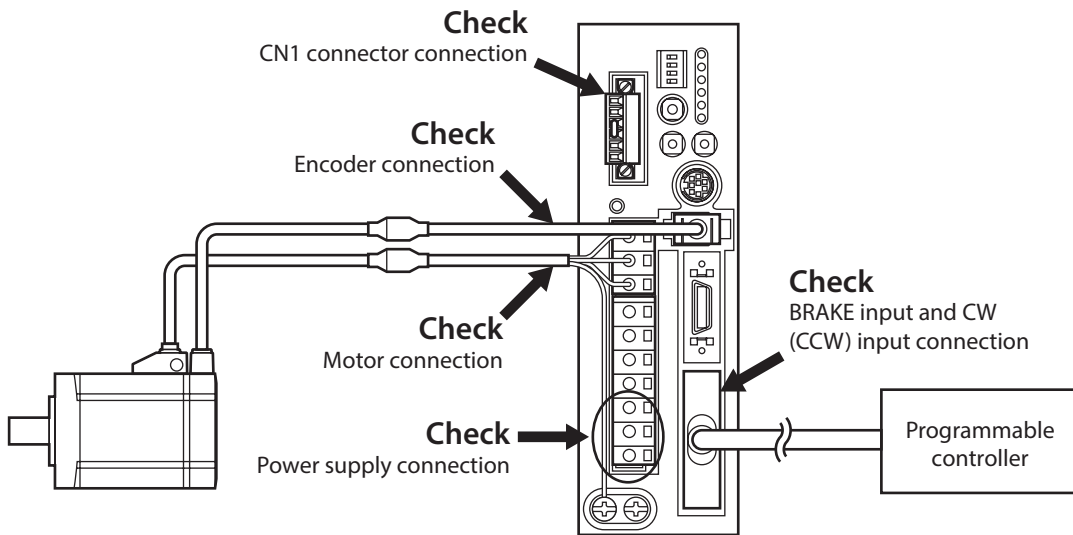

4 Speed control mode

STEP 2 Operate the motor

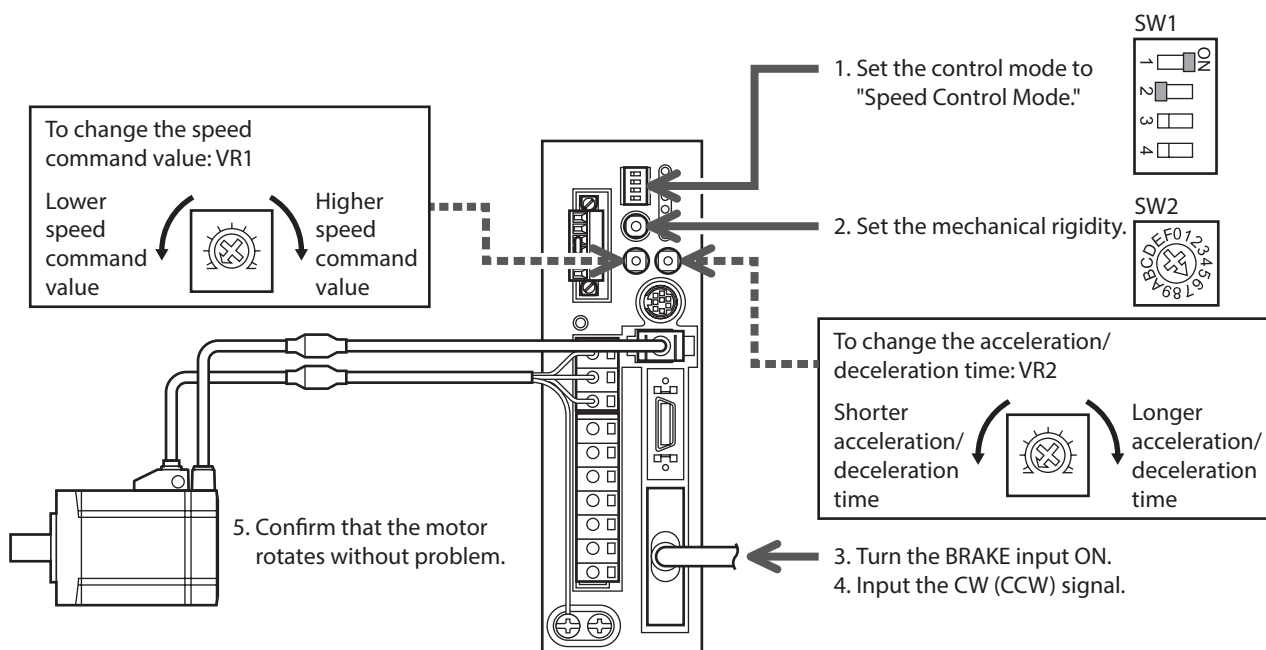

memo The new settings of the control mode setting switches will become effective after the power is turned on again. If a 24 VDC power supply is used, also turn on the 24 VDC power supply again.

STEP 3 Were you able to operate the motor properly?

How did it go? Were you able to operate the motor properly?
 If the motor does not function, check the following points:

- Is the BRAKE input ON?
- Are the thermal terminals for regeneration resistor (TH1 and TH2) on the CN1 (shorted)?
- Is any alarm present?
- Are the power supply and motor connected securely?
- Is the SPD LED (green) lit?
- Isn't the VR1 set to 0 r/min?

For more detailed settings and functions, refer to the following pages.

4 Speed control mode

2 List of setting items

The items that can be set in the speed control mode are listed below.
You can use the **MEXE02** or the **OPX-2A** to set operation data or change the internal parameters of the driver.

2-1 Operation data

Item	Description	Setting range
Operating speed	Sets the operating speed.	0 to 5,500 [r/min]
Acceleration time	Sets the acceleration time per 1,000 r/min.	5 to 10,000 [ms]
Deceleration time	Sets the deceleration time per 1,000 r/min.	5 to 10,000 [ms]
Torque limit	Sets the torque limit value.	0 to 300 [%]

2-2 Application parameters

MEXE02 tree view	Name	Description	Setting range
Gain	Gain tuning mode selection	Selects the gain tuning mode.	0: Automatic 1: Semi-auto 2: Manual
	Load inertial moment ratio	Sets the ratio of load inertial moment and motor inertial moment.	0 to 10,000 [%]
	Mechanical rigidity setting	Selects the rigidity applicable to automatic, semi-auto or manual tuning.	0 to 15
	Position loop gain	Sets the position loop gain. When this value is increased, the response will increase.	1 to 200 [Hz]
	Speed loop gain	Sets the speed loop gain. When this value is increased, the response will increase.	1 to 1,000 [Hz]
	Speed loop integral time constant	Sets the speed loop integral time constant. When this value is decreased, the response will increase.	1.0 to 500.0 [ms]
	Speed feed-forward ratio	Sets the speed feed-forward ratio. This parameter can be used to shorten the positioning time.	0 to 100 [%]
I/O	S-ON signal logic	Changes the S-ON input logic.	0: Normally open 1: Normally closed
	BRAKE signal logic	Changes the BRAKE input logic.	0: Normally open 1: Normally closed
	Output signal selection 1	Selects the output signal.	0: WNG output 1: MOVE output 2: MBC output
	Output signal selection 2	Selects the output signal.	0: ZSG2 output 1: ZV output
	Zero speed output band	Sets the output condition for ZV output.	1 to 5,500 [r/min]
	Attained speed output band	Sets the output condition for VA output.	1 to 5,500 [r/min]
	Minimum ON time for MOVE signal	Sets the minimum ON time for MOVE output.	0 to 255 [ms]
	Alarm code output	Changes the setting to enable/disable alarm code output.	0: Disable 1: Enable

MEXE02 tree view	Name	Description	Setting range
Analog	Analog speed command gain	Sets the speed command per 1 V of analog input voltage.	0 to 5,500 [r/min]
	Analog speed command clamp	Sets the speed at which to clamp the analog speed command to zero.	0 to 500 [r/min]
	Analog speed command offset voltage	Sets the offset voltage for analog speed command input.	-1.00 to 1.00 [V]
	Analog torque limit gain	Sets the torque limit per 1 V of analog input voltage.	0 to 300 [%]
	Analog torque limit offset voltage	Sets the offset voltage for analog torque limit input.	-1.00 to 1.00 [V]
	Analog input signal automatic offset	Changes the setting to enable/disable automatic offset for analog input signals.	0: Disable 1: Enable
	Analog speed monitor maximum value	Sets the maximum value of monitored analog speed. This setting determines the slope of output of monitored analog speed.	1 to 6,000 [r/min]
	Analog speed monitor maximum voltage	Sets the monitored output voltage corresponding to the maximum value of monitored analog speed.	1 to 10 [V]
	Analog speed monitor offset voltage	Sets the offset voltage for monitored analog speed.	-1.00 to 1.00 [V]
	Analog torque monitor maximum value	Sets the maximum value of monitored analog torque. This setting determines the slope of output of monitored analog torque.	1 to 300 [%]
	Analog torque monitor maximum voltage	Sets the monitored output voltage corresponding to the maximum value of monitored analog torque.	1 to 10 [V]
	Analog torque monitor offset voltage	Sets the offset voltage for monitored analog torque.	-1.00 to 1.00 [V]
	Alarm/warning	Overvoltage warning	Sets the voltage under which an overvoltage warning generates.
Undervoltage warning		Sets the voltage under which an undervoltage warning generates.	120 to 280 [V]
Overheat warning		Sets the temperature under which an overheat warning generates.	40 to 85 [°C]
Overload warning		Sets the condition under which an overload warning generates.	1 to 100 [%]
Overspeed warning		Sets the speed under which an overspeed warning generates.	1 to 6,000 [r/min]
Function	Mechanical rigidity setting switch	Changes the setting to enable/disable the mechanical rigidity setting switch (SW2) on the driver.	0: Disable 1: Enable
	Deceleration rate of speed monitor	The deceleration rate can be set when the actual speed for the output shaft of the geared motor is monitored.	1.0 to 100.0
Manual operation and display	JOG operation speed	Sets the operating speed of JOG operation.	1 to 300 [r/min]
	Data setter speed display	Shows the speed on the OPX-2A with a sign or as an absolute value.	0: Signed 1: Absolute value
	Data setter edit	Sets whether it is possible to edit using the OPX-2A .	0: Disable 1: Enable

2-3 System parameters

MEXE02 tree view	Name	Description	Setting range
Electronic gear	Encoder output electronic gear A	Sets the denominator of the electronic gear for encoder output.	1 to 1,000
	Encoder output electronic gear B	Sets the numerator of the electronic gear for encoder output.	1 to 1,000
Operation	Operation selection after stopping in speed control mode	Sets how the motor should operate after stopping in the speed control mode.	0: Free 1: Servo lock
	Analog input signals	Changes the setting to enable/disable the analog input signals.	0: Disable 1: Enable
	Motor rotation direction	Selects rotation direction of the motor.	0: +=CCW 1: +=CW
	Data-setter initial display	Selects the initial screen to be displayed when the OPX-2A starts communicating with the driver. If the selected item is not supported in the speed control mode, the top screen of the monitor mode is displayed as the initial display.	0: Operating speed [r/min] 1: Position [steps] 2: Torque [%] 3: Estimated inertial moment ratio [%] 4: Operation number 5: Selected number 6: Tension [%] 7: Revolution counter [rev] 8: Roll diameter [mm] 9: Top screen of monitor mode

3 Speed control operation

The motor operates continuously while the CW input or CCW input is ON.
Follow the steps below to perform speed controlled operation:

- Step 1 Setting the speed command value and acceleration/deceleration time
- Step 2 Setting the operation after stopping
- Step 3 Setting the motor rotation direction
- Step 4 Performing the speed controlled operation

Step 1 Setting the speed command value and acceleration/ deceleration time

Set a speed command value and acceleration/deceleration time under each of eight operation data numbers from 0 to 7.

When the system parameter for analog input signals is set to "1: Enable," two analog points and six digital points are available to assign settings. If the parameter is set to "0: Disable," eight digital points are available to assign settings.

Operation data	Analog input signals		
	Enable (initial value)		Disable
	Speed command	Acceleration/deceleration time	Speed command and acceleration/deceleration time
No.0	Analog setting (internal potentiometer VR1)	Analog setting * (internal potentiometer VR2)	Digital setting
No.1	Analog setting (External potentiometer or external DC voltage)	Analog setting * (internal potentiometer VR2)	Digital setting
No.2 to No.7	Digital setting		

* The acceleration time and deceleration time are the same.

memo One set of the operating speed, the acceleration time, the deceleration time, and the torque limit can be set in the operation data No.0 to No.7 each. Use by switching an operation data according to the operating condition. Select an operation data based on a combination of the ON/OFF status of the M0 to M2 inputs.

● Initial value

Operation data	Operating speed [r/min]	Acceleration time [ms/(1,000 r/min)]	Deceleration time [ms/(1,000 r/min)]	Torque limit [%]
No.0 to No.7	0	100	100	0

● Data selection method

Operation data	M2 input	M1 input	M0 input
No.0	OFF	OFF	OFF
No.1	OFF	OFF	ON
No.2	OFF	ON	OFF
No.3	OFF	ON	ON
No.4	ON	OFF	OFF
No.5	ON	OFF	ON
No.6	ON	ON	OFF
No.7	ON	ON	ON

■ Using the internal potentiometer VR1

1. Set the system parameter for analog input signals to "1: Enable."



When a system parameter has been changed, the new setting will become effective after the power is turned on again. If a 24 VDC power supply is used, also turn on the 24 VDC power supply again.

2. Turn the M0 to M2 inputs OFF and select operation data No.0.
3. Set the speed command using the internal potentiometer VR1.
Setting range: 0 r/min or 10 to 5,500 r/min
Factory setting: 0 r/min

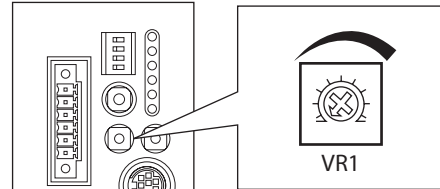

4. Set the acceleration/deceleration time using the internal potentiometer VR2.
The acceleration/deceleration time represents the time needed for the operating speed to reach 1,000 r/min as shown in the figure below.
The acceleration time and deceleration time are the same.
Setting range: 5 to 10,000 ms / (1,000 r/min)
Factory setting: 5 ms / (1,000 r/min)

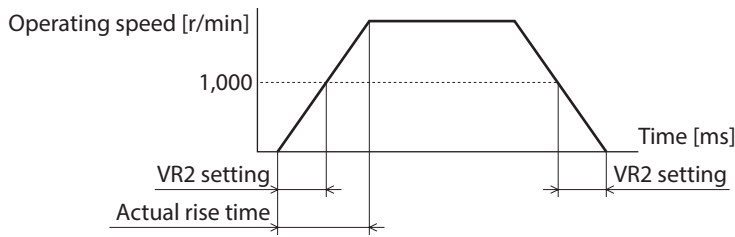
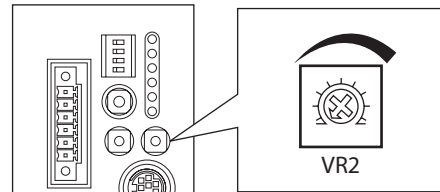

■ Using an external potentiometer or external DC voltage

1. Set the system parameter for analog input signals to "1: Enable."



When a system parameter has been changed, the new setting will become effective after the power is turned on again. If a 24 VDC power supply is used, also turn on the 24 VDC power supply again.

2. Turn the M0 input ON and M1 and M2 inputs OFF, and select operation data No.1.
3. Connect an external potentiometer or external DC voltage to pin No.1 to No.3 of the analog I/O connector (CN6). Refer to p.56 for details on the connection method.
4. Set the gain.
Set the speed command value per 1 V of voltage command in the application parameter for analog speed command gain.
Setting range: 0 to 5,500 r/min
Initial value: 550 r/min
5. Set the lower limit of the speed.
The lower limit value of the speed represents that the speed command value below the predetermined speed is fixed to 0 r/min. Set which speed is fixed to 0 r/min using the "Analog speed command clamp" parameter. The initial value of the "Operation selection after stopping in speed control mode" parameter is "0: Free." If this parameter is set to "1: Servo lock," the "Analog speed command clamp" parameter is disabled.
6. Set the offset.
If there is even a slight margin of error in the voltage value, the speed command value may not become 0 r/min even when the voltage command specifies 0 V (minimum value). In this case, adjust the offset using one of the two methods described below.

Automatic adjustment

- 1) Set the application parameter for Analog input signal automatic offset to "1: Enable."
- 2) Input 0 V to the analog input terminal (pin No.1 of CN6).
- 3) Apply the offset for analog speed input using the **MEXE02** or the **OPX-2A**.

Adjustment using a parameter

- 1) Set the application parameter for Analog input signal automatic offset to "0: Disable."
 - 2) Set the offset voltage in the application parameter for analog speed command offset voltage.
7. Set the speed command value using an external potentiometer or external DC voltage.
 8. Set the acceleration/deceleration time using the internal potentiometer VR2.
The acceleration time and deceleration time are the same.
Setting range: 5 to 10,000 ms/(1,000 r/min)
Factory setting: 5 ms/(1,000 r/min)

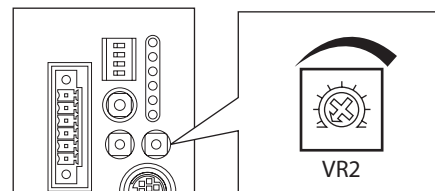

Setting example

Setting example	Analog speed command gain	Analog speed command clamp	Analog speed command offset voltage	Description
①	550 r/min	0 r/min	0 V	The speed command value per 1 V of voltage command becomes 550 r/min.
②	10 r/min	0 r/min	0 V	The speed command value per 1 V of voltage command becomes 10 r/min.
③	550 r/min	0 r/min	1 V	The home of voltage command becomes 1 V. The gain of speed command value is the same as in example ①.
④	550 r/min	10 r/min	0 V	If the speed command value is set less than 10 r/min of the voltage command, the speed command value will be 0 r/min. *

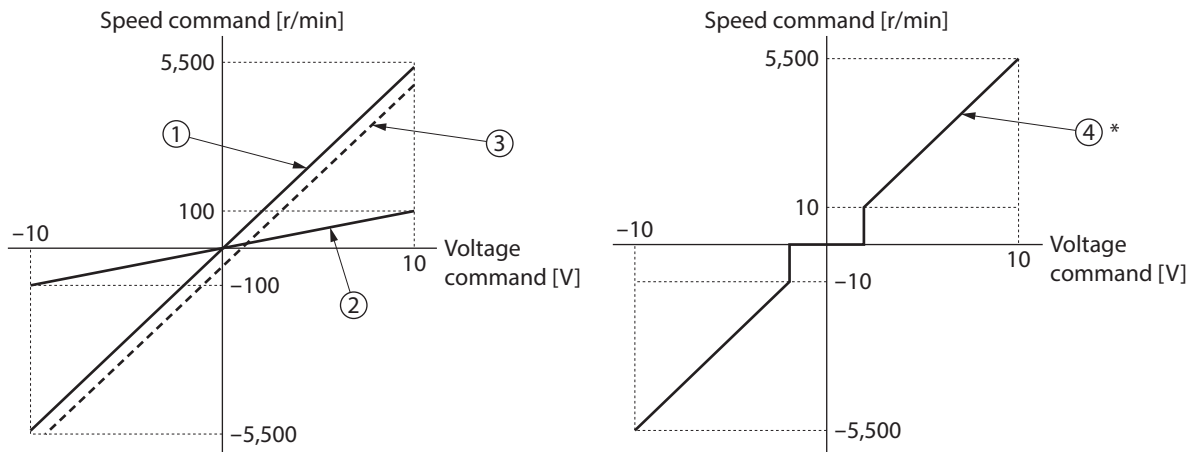

* It is enabled when the "Operation selection after stopping in speed control mode" parameter is set to "0: Free."

■ Digital setting

● **When the analog input signals parameter is set to "1: Enable"**

1. Set the system parameter for analog input signals to "1: Enable."

memo When a system parameter has been changed, the new setting will become effective after the power is turned on again. If a 24 VDC power supply is used, also turn on the 24 VDC power supply again.

2. Use the **MEXE02** or the **OPX-2A** to set one of operation data No.2 to No.7 as the speed command value.
3. Combine the ON/OFF statuses of M0 to M2 inputs to select one of operation data No.2 to No.7.

● **When the analog input signals parameter is set to "0: Disable"**

1. Set the system parameter for analog input signals to "0: Disable."

memo When a system parameter has been changed, the new setting will become effective after the power is turned on again. If a 24 VDC power supply is used, also turn on the 24 VDC power supply again.

2. Use the **MEXE02** or the **OPX-2A** to set one of operation data No.0 to No.7 as the speed command value.
3. Combine the ON/OFF statuses of M0 to M2 inputs to select one of operation data No.0 to No.7.

Step 2 Setting the operation after stopping

In the speed control mode, you can set how the motor should operate after stopping, in the system parameter for operation selection after stopping in speed control mode.

- **When the parameter for operation selection after stopping in speed control mode is set to "0: Free" (initial value)**

Starting/stopping of the motor is interlocked with motor excitation. The motor puts into a non-excitation state when it is at a standstill, and the output shaft loses the holding force to be rotated by an external force. The motor will be excited the moment it is started.

In the case of an electromagnetic brake motor, actuation/release of the electromagnetic brake is controlled in interlock with motor excitation.

- **When the parameter for operation selection after stopping in speed control mode is set to "1: Servo lock"**

Motor excitation is controlled by the S-ON input. Even when it is not operating, the motor remains excited and the position is being held as long as the S-ON input is ON. However, the position may change if the position deviation is large.

In the case of an electromagnetic brake motor, actuation/release of the electromagnetic brake is controlled in interlock with motor excitation.



When a system parameter has been changed, the new setting will become effective after the power is turned on again. If a 24 VDC power supply is used, also turn on the 24 VDC power supply again.

Step 3 Setting the motor rotation direction

Set a desired motor rotation direction using the system parameter for motor rotation direction.



When a system parameter has been changed, the new setting will become effective after the power is turned on again. If a 24 VDC power supply is used, also turn on the 24 VDC power supply again.

When the speed command is a positive value

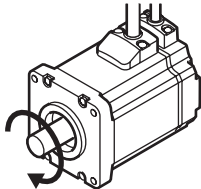
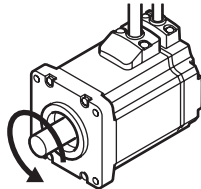
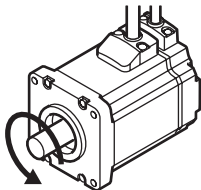
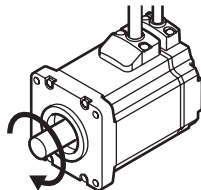
Setting of motor rotation direction parameter	CW input ON	CCW input ON
When "1: + = CW" is set	The motor rotates in CW direction. 	The motor rotates in CCW direction. 
When "0: + = CCW" is set	The motor rotates in CCW direction. 	The motor rotates in CW direction. 

If the speed command is a negative value, the rotation direction is reversed.

Step 4 Performing the speed controlled operation

1. Turn the BRAKE input ON.
If the parameter for operation selection after stopping in speed control mode is set to "1: Servo lock," also turn the S-ON input ON.
When the motor becomes ready, the READY output will turn ON.
2. Set the speed command value.
Analog setting: Set a desired value using the internal/external potentiometer or external DC voltage.
Digital setting: Set a desired operation data number based on a combination of ON/OFF statuses of M0 to M2 inputs.
3. Turn the CW input or CCW input ON.
A speed controlled operation starts according to the speed command value set in step 2.
4. Turn the CW input or CCW input OFF.
The motor decelerates to a stop.
Even if the CW input and CCW input are turned ON simultaneously, the motor will still decelerate until it stops.
Once the motor operation ends and the rotor enters the zero speed output band, the ZV output will turn ON.

- When the parameter for operation selection after stopping in speed control mode is set to "0: Free"

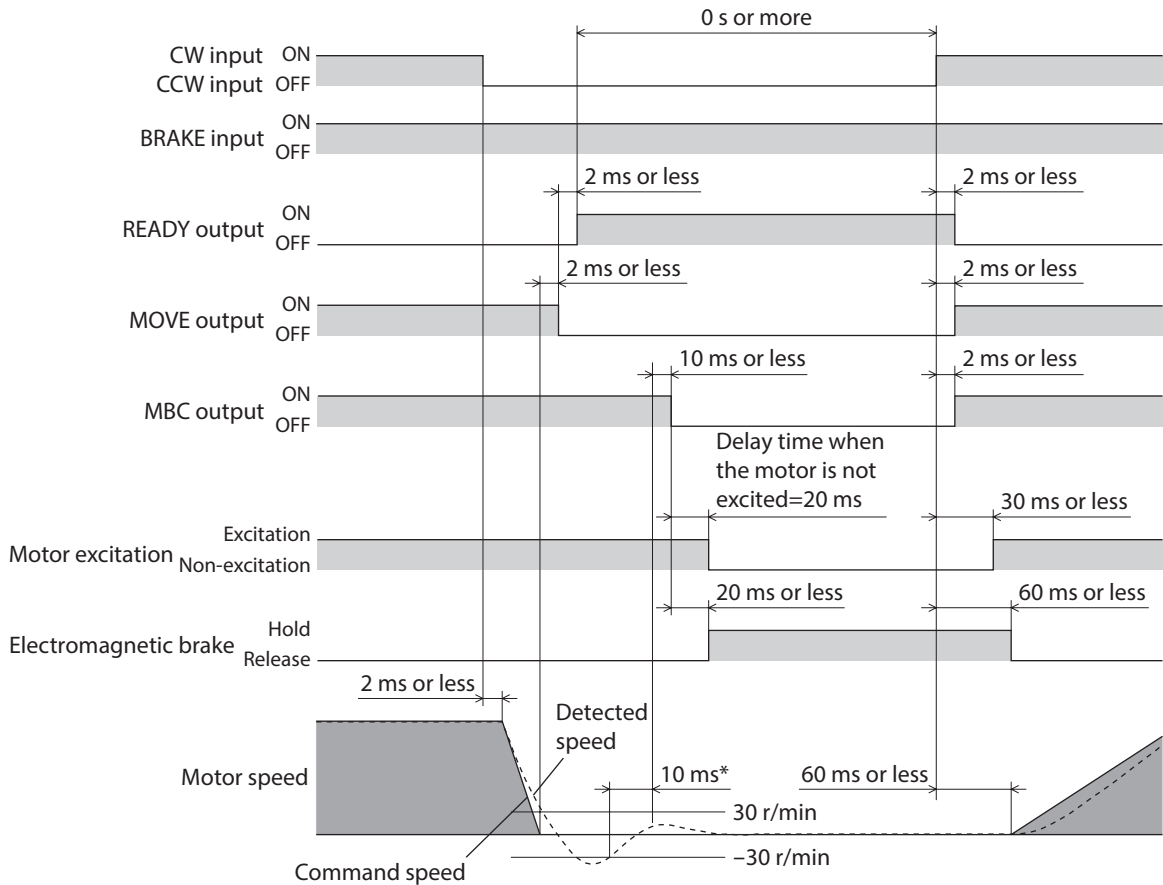

* If the detected speed remains at or below ± 30 r/min for 10 ms or more, the MBC output will turn OFF.

- When the parameter for operation selection after stopping in speed control mode is set to "1: Servo lock"

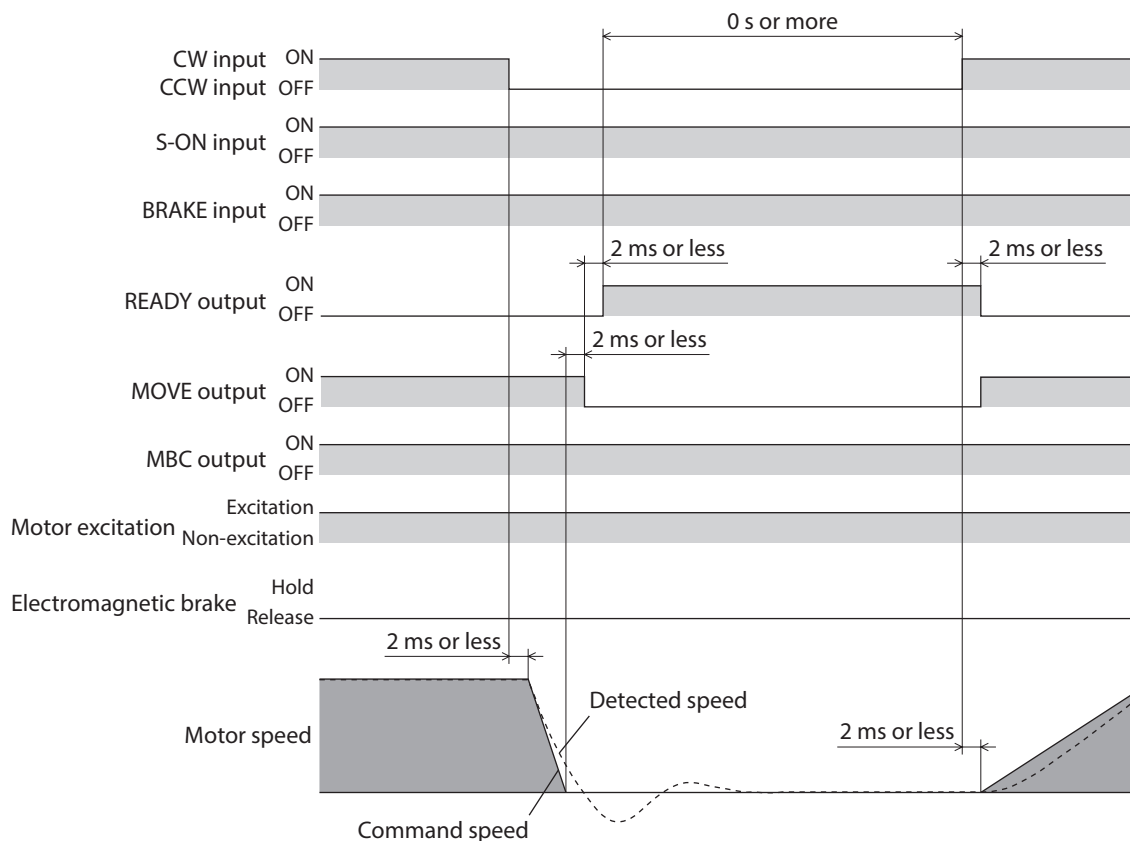

■ Exciting the motor: S-ON input

This input is effective when the parameter for operation selection after stopping in speed control mode is set to "1: Servo lock."

Turning the S-ON input ON will excite the motor. In the case of an electromagnetic brake motor, the electromagnetic brake will be released after the motor is excited.

When the S-ON input is OFF, the deviation counter will be cleared and input operation commands will be ignored. You can set the S-ON input to function in the contact A (normally open) or B (normally closed) logic using the application parameter for S-ON signal logic (the initial value is to use the contact A logic (normally open)). If the S-ON input is set to use the contact B (normally closed) logic, the motor will be excited automatically after the power is turned on and turning the S-ON input ON will cause the motor to lose its holding torque.

Note If the S-ON input is turned ON when only the 24 VDC power is input, a main power supply warning will generate. If a pulse signal is input while a main power supply warning is present, a main power supply error will generate.

■ Stopping the motor instantaneously: BRAKE input

The motor can be stopped instantaneously by turning the BRAKE input OFF. To operate the motor, turn the BRAKE input ON.

If the application parameter for BRAKE signal logic is set to "0: Contact A (normally open)," the motor will stop instantaneously when the BRAKE input turns ON.

■ Notifying that the motor is ready: READY output

When the motor becomes ready, the READY output will turn ON. Start the operation after confirming that the READY output has turned ON. The READY output remains OFF while the motor is operating.

The READY output is OFF under the following conditions. Motor operation is disabled while the READY output is OFF:

- The main power supply is cut off.
- An alarm is present.
- The S-ON input is OFF (the S-ON signal logic is "0: Contact A (normally open)," and the operation after stopping is "1: Servo lock").
- The FREE input, CW input or CCW input is ON.
- The BRAKE input is OFF (the BRAKE input logic is "1: Contact B (normally closed)").
- A remote operation is performed using **MEXE02**.
- An operation is performed on the **OPX-2A** in the test mode or copy mode.

■ Notifying that operation is in progress: MOVE output

The MOVE output can be enabled by selecting the output using the application parameter for output signal selection 1.

The MOVE output remains ON while the motor is operating. You can set the minimum time during which the MOVE output remains ON using the application parameter for minimum ON time for MOVE signal. Even in a short operation, the MOVE output will remain ON for the time set in this parameter.

Example: When 10 ms is set in the parameter for minimum ON time for MOVE signal.

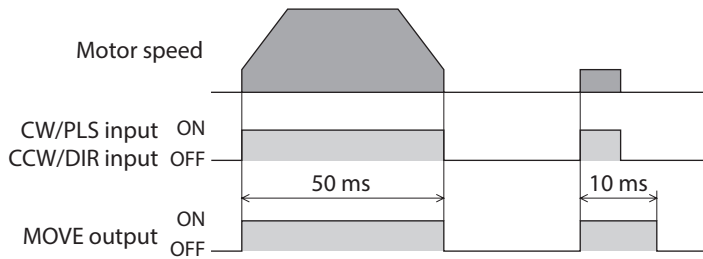

■ Notifying the timing of electromagnetic brake control: MBC output

Use the MBC output to control the electromagnetic brake using a programmable controller, etc.

The MBC output can be enabled by selecting the output using the application parameter for output signal selection 1.

The MBC output will turn ON when the electromagnetic brake is released, and turn OFF when the electromagnetic brake is actuated (= to hold the load in position). Set the programmable controller to control the electromagnetic brake by detecting the ON/OFF status of the MBC output.

■ Notifying that the detected speed has become zero: ZV output

The ZV output can be enabled by selecting the output using the application parameter for output signal selection 2.

When the detected speed drops into the zero speed output band, the ZV output will turn ON.

You can set the band within which the ZV output turns ON, using the application parameter for zero speed output band.

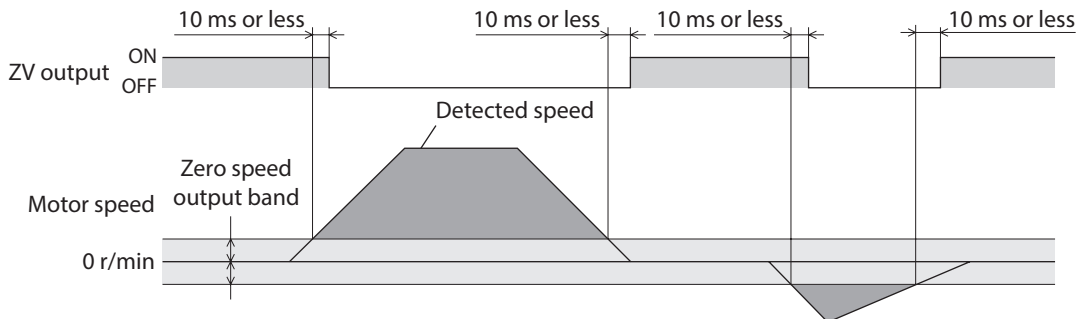

■ Notifying that the command speed has been reached: VA output

When the detected speed enters the range of “command speed ± attained speed output band,” the VA output will turn ON.
 You can set the band within which the VA output turns ON, using the application parameter for range of attained speed output band.

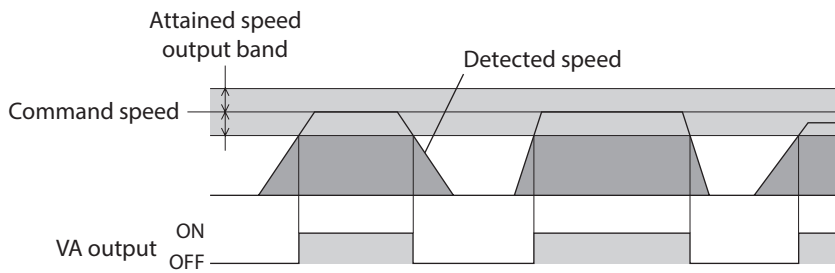

■ Freeing the motor output shaft: FREE input

When the FREE input is turned ON, the motor current will be cut off. The motor will lose its holding torque, and the output shaft can be turned with an external force.
 If the FREE input is turned ON while the position is held with the electromagnetic brake, the electromagnetic brake will be released. Accordingly, the position can no longer be held.

- When the parameter for operation selection after stopping in speed control mode is set to “0: Free”

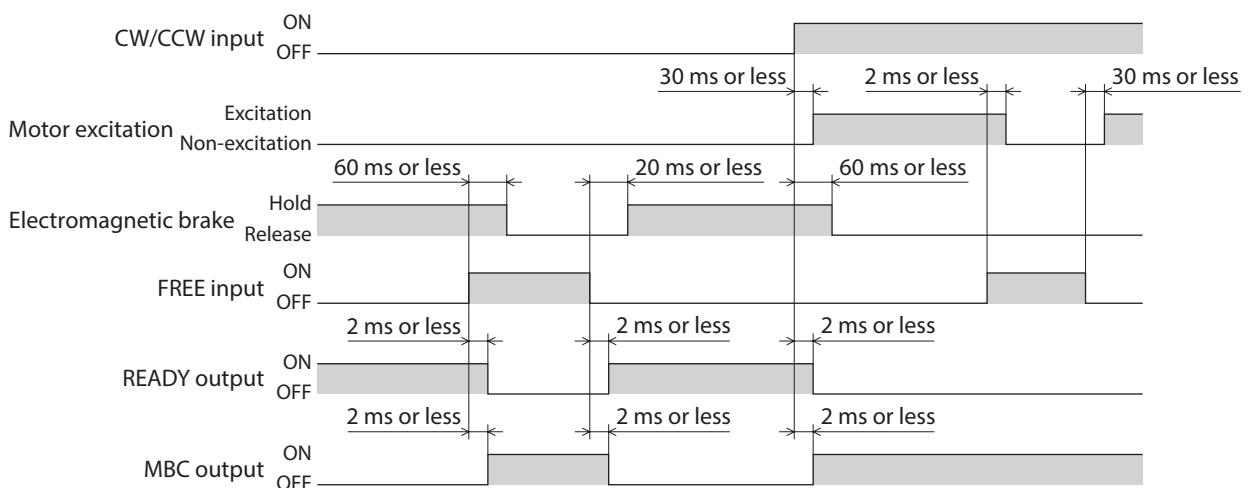

- When the parameter for operation selection after stopping in speed control mode is set to “1: Servo lock”

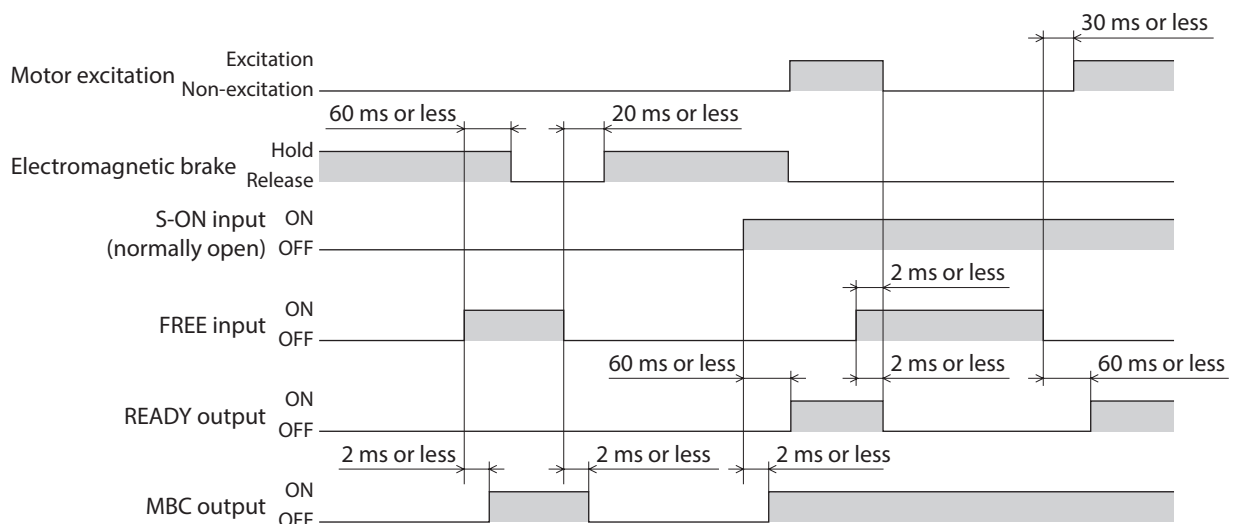

4 Torque limit

The maximum output torque of the motor can be limited by turning the TL input ON. Use this input to suppress motor torque, for your safety.

Follow the steps below to limit the maximum output torque of the motor during positioning operation:

Step 1 Setting the torque limit value

Step 2 Limiting the torque

Step 1 Setting the torque limit value

Set a torque limit value under each of eight operation data numbers from 0 to 7.

When the system parameter for analog input signals is set to "1: Enable," two analog points as well as six digital points are available to assign settings. If the parameter is set to "0: Disable," eight digital points are available to assign settings.

Set the torque limit value as an integer percentage of the rated torque being 100 % (*), in a range of 0 to 300 %.

* Set the value for geared motors based on the permissible torque being 100 %.

Operation data	Analog input signals	
	Enable (initial value)	Disable
No.0 or No.1	Analog setting (External potentiometer or external DC voltage)	Digital setting
No.2 to No.7	Digital setting	



One set of the operating speed, the acceleration time, the deceleration time, and the torque limit can be set in the operation data No.0 to No.7 each. Use by switching an operation data according to the operating condition. Select an operation data based on a combination of the ON/OFF status of the M0 to M2 inputs.

● Initial value

Operation data	Operating speed [r/min]	Acceleration time [ms/(1000 r/min)]	Deceleration time [ms/(1000 r/min)]	Torque limit [%]
No.0 to No.7	0	100	100	0

● Data selection method

Operation data	M2 input	M1 input	M0 input
No.0	OFF	OFF	OFF
No.1	OFF	OFF	ON
No.2	OFF	ON	OFF
No.3	OFF	ON	ON
No.4	ON	OFF	OFF
No.5	ON	OFF	ON
No.6	ON	ON	OFF
No.7	ON	ON	ON

■ Analog setting

1. Set the system parameter for analog input signals to "1: Enable."



When a system parameter has been changed, the new setting will become effective after the power is turned on again. If a 24 VDC power supply is used, also turn on the 24 VDC power supply again.

2. Combine the ON/OFF statuses of M0 to M2 inputs to select operation data No.0 or No.1.
3. Connect an external potentiometer or external DC voltage to pin No.4 to No.6 of the analog I/O connector (CN6). Refer to p.56 for details on the connection method.
4. Set the gain.
Set the torque limit value per 1 V of voltage command in the application parameter for analog torque limit gain.
Setting range: 0 to 300 %
Initial value: 30 %
5. Adjust the offset.
If there is even a slight margin of error in the voltage value, the torque limit value may not become 0 % even when the voltage command specifies 0 V (minimum value). In this case, adjust the offset using one of the two methods described below.

Automatic adjustment

- 1) Set the application parameter for analog input signal automatic offset to "1: Enable."
- 2) Input 0 V to the analog input terminal (pin No.5 of CN6).
- 3) Apply the offset for analog torque input using the **MEXE02** or the **OPX-2A**.

Adjustment using a parameter

- 1) Set the application parameter for analog input signal automatic offset to "0: Disable."
 - 2) Set the offset voltage in the application parameter for analog torque limit offset voltage.
 - 3) Use an external potentiometer or external DC voltage to set the torque limit value.
6. Use an external potentiometer or external DC voltage to set the torque limit value.

Setting example

Setting example	Analog torque limit gain	Analog torque limit offset voltage	Description
①	30 %	0 V	The torque limit value per 1 V of voltage command becomes 30 %.
②	10 %	0 V	The torque limit value per 1 V of voltage command becomes 10 %.
③	100 %	0 V	The torque limit value per 1 V of voltage command becomes 100 %.
④	30 %	1 V	The home of voltage command becomes 1 V. The gain of torque limit value is the same as in example ①.

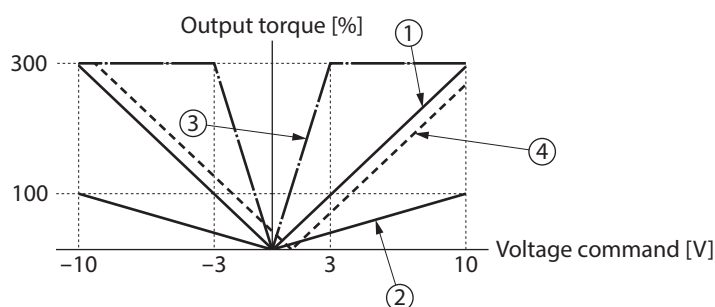

■ Digital setting

● When the analog input signals parameter is set to "1: Enable"

1. Set the system parameter for analog input signals to "1: Enable."

memo When a system parameter has been changed, the new setting will become effective after the power is turned on again. If a 24 VDC power supply is used, also turn on the 24 VDC power supply again.

2. Use the **MEXE02** or the **OPX-2A** to set one of operation data No.2 to No.7 as the torque limit value.
3. Combine the ON/OFF statuses of M0 to M2 inputs to select one of operation data No.2 to No.7.

● When the analog input signals parameter is set to "0: Disable"

1. Set the system parameter for analog input signals to "0: Disable."

memo When a system parameter has been changed, the new setting will become effective after the power is turned on again. If a 24 VDC power supply is used, also turn on the 24 VDC power supply again.

2. Use the **MEXE02** or the **OPX-2A** to set one of operation data No.0 to No.7 as the torque limit value.
3. Combine the ON/OFF statuses of M0 to M2 inputs to select one of operation data No.0 to No.7.

Step 2 Limiting the torque

Turning the TL input ON while positioning operation is in progress will limit the maximum output torque by the torque limit value you have set.

Example of limiting the torque using operation data No.1 and No.2

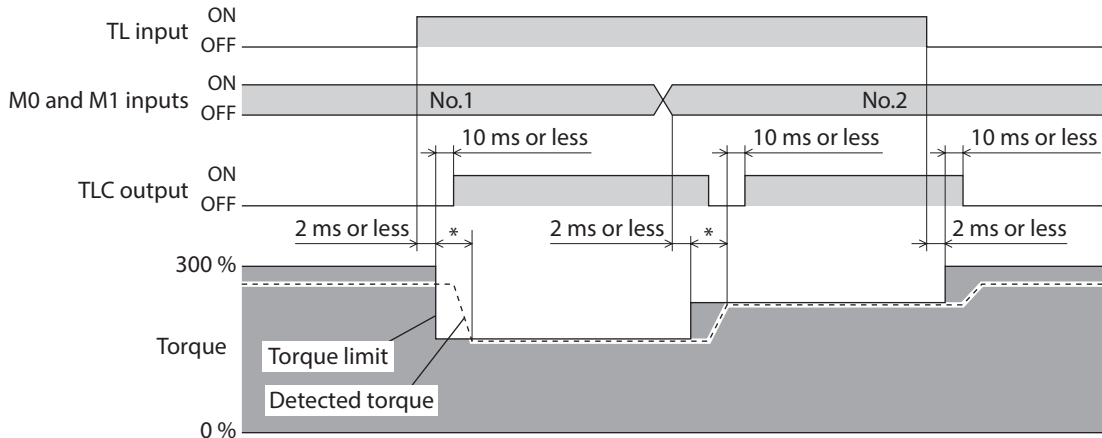

* The specific time varies depending on the load condition and gain.

Note When the maximum output torque of the motor is limited by the TL input, the motor may not rotate because of insufficient torque if a load is larger than the maximum output torque of the motor. If the TL input is turned OFF in this state, the maximum output torque of the motor will increase rapidly to cause unexpected movements of the moving part, leading to injury or damage to equipment.

■ Enabling the torque limit function: TL input

When the TL input is turned ON, the torque limit function will be enabled and the maximum output torque of the motor will be adjusted to the specified torque limit value.

While the TL input is OFF, the torque limit function is disabled and the maximum output torque of the motor remains 300 % (the rated torque corresponds to 100 %).

■ Notifying that the torque is being limited: TLC output

When the specified torque limit value is reached, the TLC output will turn ON.

5 Gain tuning

The motor compliance with respect to commands can be adjusted according to the load inertial and mechanical rigidity.

You can also tune the motor in the semi-auto or manual mode in situations where the positioning time must be shortened, or when automatic tuning is difficult due to a large or fluctuating load inertial moment.

5-1 Selecting the tuning mode

Gain tuning can be performed in three modes. Select a desired tuning mode using the application parameter for gain tuning mode selection. Automatic tuning supports an adjustment range of up to 50 times the rotor inertial moment, while manual tuning supports an adjustment range of up to 100 times.

- Automatic..... The load inertial moment is estimated internally by the driver. Simply set the mechanical rigidity and the gain will be adjusted automatically.
- Semi-auto..... Set the mechanical rigidity and load inertial moment ratio, and the gain will be adjusted automatically.
- Manual..... The customer must set the gain directly. Select this mode when the load inertia is large or the response needs to be increased above the level achievable by automatic tuning.

The parameters that can be set vary depending on the tuning mode.

Name	Automatic	Semi-auto	Manual
Load inertial moment ratio	–	○	○
Mechanical rigidity setting	○	○	○
Position loop gain *	–	–	○
Speed loop gain	–	–	○
Speed loop integral time constant	–	–	○
Speed feed-forward ratio *	–	–	○

* This parameter is used when the parameter for operation selection after stopping in speed control mode is set to "1: Servo lock."

5-2 Gain tuning mode

■ Automatic

Set the mechanical rigidity using the mechanical rigidity setting switch (SW2) on the driver or the application parameter for mechanical rigidity setting.

Which value should be made effective is selected using the application parameter for mechanical rigidity setting switch.

Once the mechanical rigidity is set, the gain will be adjusted automatically.

Refer to p.113 for details on the range of gains that can be set with automatic tuning.

SW2 dial setting	Value of mechanical rigidity setting switch parameter	Reference mechanical rigidity
0 to 3	0 to 3	Low rigidity (belt pulley, etc.)
4 to 9	4 to 9	Medium rigidity (chain, etc.)
A to F	10 to 15	High rigidity (ball screw, directly coupled load, etc.)

Note The higher the value of mechanical rigidity, the higher the motor response becomes. Note, however, that an excessively high value may cause vibration or noise.

memo The estimated value of load inertial moment is saved in the driver's non-volatile memory every 20 minutes.

■ Semi-auto

1. Set the application parameter for load inertia moment ratio.
The load inertial moment ratio refers to the percentage of the inertial moment of the load to the rotor inertial moment of the motor. If the rotor inertial moment is equal to the load inertial moment, the load inertial moment ratio becomes 100 %. Refer to the catalog for the rotor inertial moment of your motor.
If the equipment is complex and estimating the load is difficult, you can use the **MEXE02** or the **OPX-2A** to monitor the load inertial moment ratio estimated by the driver.
2. Set the mechanical rigidity in the same manner as in the “automatic” mode.
Once the mechanical rigidity and load inertial moment ratio are set, the gain will be adjusted automatically. Refer to p.113 for details on the range of gains that can be set with semi-auto tuning.

■ Manual

Follow the procedure below to adjust the gain with a sufficient margin.

1. Set the application parameter for load inertia moment ratio.
The load inertial moment ratio refers to the percentage of the inertial moment of the load to the rotor inertial moment of the motor. If the rotor inertial moment is equal to the load inertial moment, the load inertial moment ratio becomes 100 %. Refer to the catalog for the rotor inertial moment of your motor.
If the equipment is complex and estimating the load is difficult, you can use the **MEXE02** or the **OPX-2A** to monitor the load inertial moment ratio estimated by the driver.
2. Set the mechanical rigidity in the same manner as in the “automatic” mode.
3. Adjust the compliance with respect to speed deviation. Set the application parameter for speed loop gain.
Increasing the speed loop gain will decrease the deviation between the command speed and actual speed. Note, however, that an excessively high value may increase the motor overshoot or cause hunting.
4. Decrease the deviation that cannot be adjusted with the speed loop gain. Set the application parameter for speed loop integral time constant.
If the integral time constant is too high, motor operation will become slow. If the constant is too low, on the other hand, hunting may occur.
5. When the parameter for operation selection after stopping in speed control mode is set to “1: Servo lock,” adjust the compliance with respect to position deviation. Set the application parameter for position loop gain.
Increasing the position loop gain will decrease the deviation between the command position and actual position. Note, however, that an excessively high value may increase the motor overshoot or cause hunting.
6. Repeat step 2 to step 5 to set an optimal gain.

■ Speed feed-forward ratio

This parameter can be set when the parameter for operation selection after stopping in speed control mode is set to “1: Servo lock.”

If the speed is constant, the deviation between the command position and actual position can be reduced to shorten the settling time.

Setting the speed feed-forward ratio to 100 % will bring the deviation down to nearly 0. Note, however, that an excessively high value may increase the motor overshoot or undershoot.

5-3 Gains that can be set with automatic tuning/semi-auto tuning

In automatic tuning and semi-auto tuning, the gain is set automatically.
The table summarizes different conditions and corresponding gains.

SW2 dial setting	Value of mechanical rigidity setting switch parameter	Position loop gain [Hz]	Speed loop gain [Hz]	Speed loop integral time constant [ms]	Speed feed-forward ratio [%]
0	0	3	14	51.0	80
1	1	4	22	51.0	80
2	2	6	32	48.2	80
3	3	9	46	33.8	80
4	4	11	56	28.4	80
5	5	14	68	23.4	80
6	6	16	82	19.4	80
7	7	20	100	15.8	80
8	8	20	120	13.2	80
9	9	20	150	10.6	80
A	10	20	180	8.8	80
B	11	20	220	7.2	80
C	12	20	270	5.8	80
D	13	20	330	4.8	80
E	14	20	390	4.0	80
F	15	20	470	3.4	80

5-4 Method of gain tuning using the MEXE02

You can adjust parameters while checking the motor speeds and I/O signal status in waveforms.

1. Click the [Gain tuning] icon in the toolbar or click the [Gain tuning] short-cut button.
The gain tuning window appears.



2. Click "Start Gain Tuning."

The buttons in the window are enabled, allowing you to prepare for measurement of gain tuning.



4 Speed control mode

1	Measurement results are drawn in this area.
2	The settings of gain tuning can be specified.
3	The measurement conditions for each CH can be set.
4	Waveform measurement settings: Level, CH, Mode, Edge (detection condition), and Pos (trigger position) can be specified. For "CH," only those CHs displayed at ① can be specified.
5	Run: This button is used to start measurement. Stop: This button is used to stop measurement.
6	The measurement time range can be set.
7	The display method for CH3 and CH4 can be set. Scale: The display size can be selected from 1/1 (100 %), 1/2 (50 %), or 1/4 (25 %). Signal name: The signal name can be shown or hidden.
8	The measure for measurement can be shown or hidden. Also, the CH to be measured can be selected.
9	The display positions of waveforms drawn in the window can be moved. There are the following two moving methods. · Move the waveform per CH. · Move the waveform of the CH selected in ③ simultaneously.
10	The currently displayed waveform can be copied to the clipboard.
11	The currently displayed waveform can be saved to an external file.
12	The setting for measurement can be loaded from "favorites data."
13	The setting for measurement can be saved as "favorites data."

The gain tuning requires synchronization of the data under editing and the driver data. When the data is not synchronized, the following window appears. Select a synchronization method and click [OK].

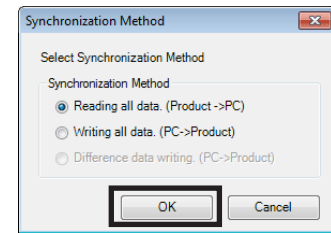

When the above window appears, all the communications in progress are disabled. All the other monitors in progress in other windows are also stopped. Resume monitor after synchronization is completed.

- Click the "CH setting" tab.
The measurement conditions for each CH can be set.

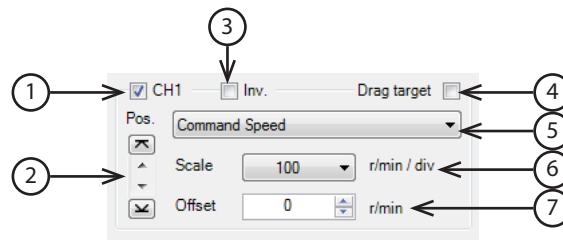

1	Each CH can be shown or hidden.
2	The display position of a waveform can be moved up or down.
3	The display of measured signal can be inverted.
4	Selecting this check box can drag displayed waveforms drawn in the window simultaneously.
5	This is used to select a signal to be measured.
6	This is used to select a display scale for signals (CH1 and CH2 only). Using this setting in combination with 7 can zoom in on signals.
7	The set offset value is added to the signal display (CH1 and CH2 only). Using this setting in combination with 6 can zoom in on signals.

- Click [Run].
The waveform measurement starts.
- During measurement, click [Stop] to exit the waveform measurement.
If "SINGLE" is selected for Mode in Trigger, measurement automatically ends when waveform drawing ends.
- Click the [GAIN] tab when adjusting the parameter while checking the status of the waveform.
- Click [Writing to Device] after editing the parameter.
The changed parameter will be written to the driver.
- To exit the waveform measurement, unselect "Start Gain Tuning."

Inertia moment ratio [%]	500
Rigidity settings	15
Position loop gain [Hz]	10
Speed loop gain [Hz]	50
Speed loop integral time constant [ms]	31.8
Speed feedforward ratio [%]	0
Anti-vibration frequency #0 [Hz]	30.00
Anti-vibration frequency #1 [Hz]	30.00
Anti-vibration frequency #2 [Hz]	30.00
Anti-vibration frequency #3 [Hz]	30.00

5 Torque control mode

This part explains the functions and operation of the torque control mode.

◆ Table of contents

1	Guidance	118
2	List of setting items.....	120
	2-1 Operation data	120
	2-2 Application parameters.....	120
	2-3 System parameters	121
3	Torque control operation.....	122
4	Speed limit.....	129
	4-1 Using the internal potentiometer VR2..	129
	4-2 Using an external potentiometer or external DC voltage	130
	4-3 Digital setting.....	131



1 Guidance

The following functions are available in the torque control mode:

- Torque controlled operation.....The motor is operated in a manner controlling its output torque at a specified level.
- Speed limit.....The speed of the motor operating under torque control is limited.

If you are new to the **NX** Series driver, read this section to understand the operating methods along with the operation flow.

Note Before operating the motor, check the condition of the surrounding area to ensure safety.

STEP 1 Check the installation and connection

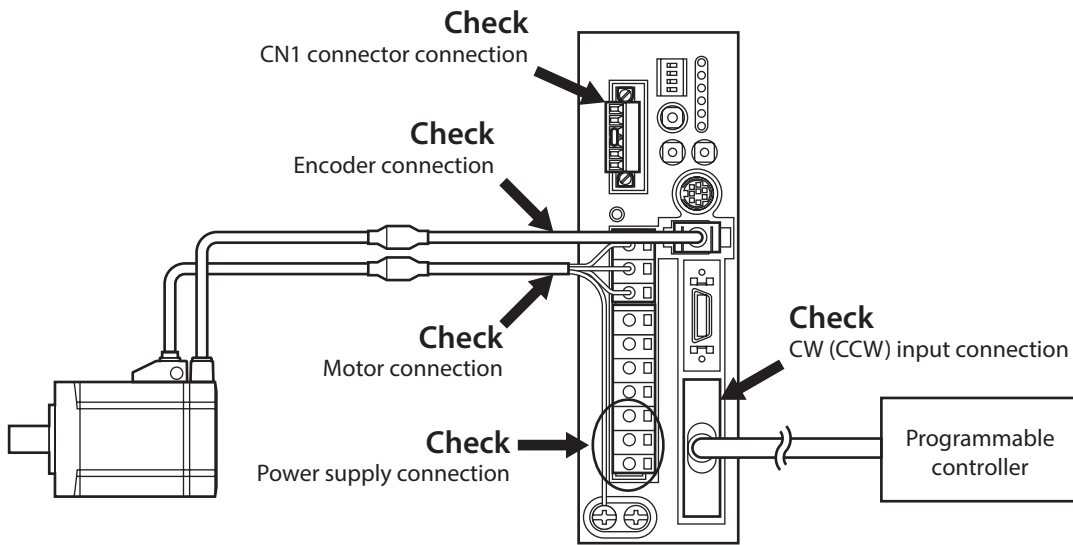

STEP 2 Operate the motor

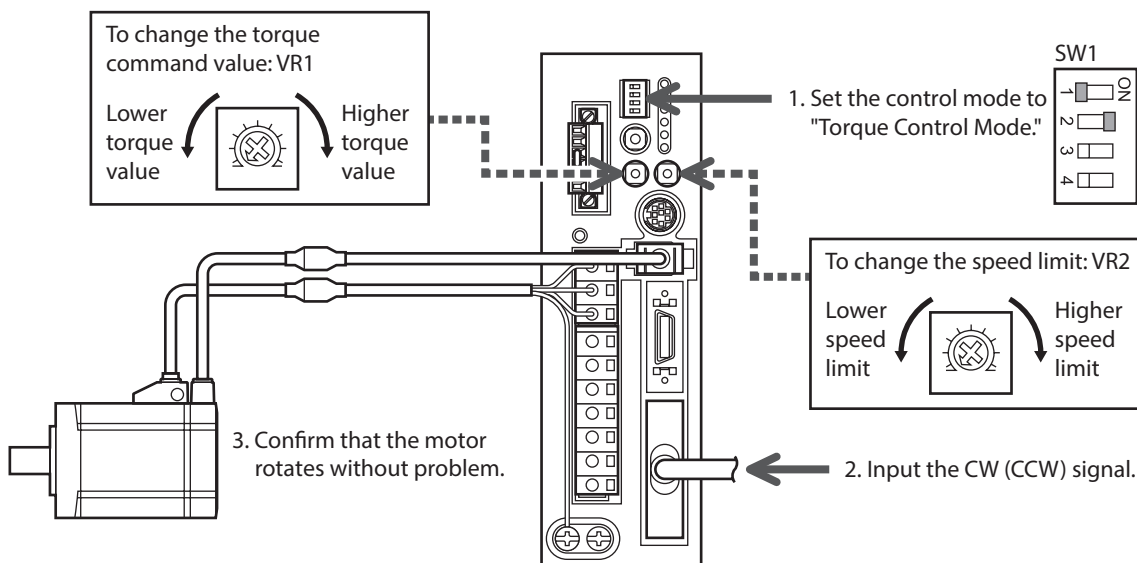

memo The new settings of the control mode setting switches will become effective after the power is turned on again. If a 24 VDC power supply is used, also turn on the 24 VDC power supply again.

STEP 3 Were you able to operate the motor properly?

How did it go? Were you able to operate the motor properly?

If the motor does not function, check the following points:

- Are the thermal terminals for regeneration resistor (TH1 and TH2) on the CN1 (shorted)?
- Is any alarm present?
- Are the power supply and motor connected securely?
- Is the TRQ LED (green) lit?
- Isn't the VR2 set to 0 r/min?

For more detailed settings and functions, refer to the following pages.

2 List of setting items

The items that can be set in the torque control mode are listed below.

You can use the **MEXE02** or the **OPX-2A** to set operation data or change the internal parameters of the driver.

2-1 Operation data

Item	Description	Setting range
Speed limit	Sets the speed limit value.	0 to 5,500 [r/min]
Torque command	Sets the torque command value. The rated torque corresponds to 100 %.	0 to 300 [%]

2-2 Application parameters

MEXE02 tree view	Name	Description	Setting range
I/O	Output signal selection 1	Selects the output signal.	0: WNG output 1: MOVE output 2: MBC output
	Output signal selection 2	Selects the output signal.	0: ZSG2 output 1: ZV output
	Zero speed output band	Sets the output condition for ZV output.	1 to 5,500 [r/min]
	Minimum ON time for MOVE signal	Sets the minimum ON time for MOVE output.	0 to 255 [ms]
	Alarm code output	Changes the setting to enable/disable alarm code output.	0: Disable 1: Enable
Analog	Analog speed limit gain	Sets the speed limit per 1 V of analog input voltage.	0 to 5,500 [r/min]
	Analog speed limit offset voltage	Sets the offset voltage for analog speed limit input.	-1.00 to 1.00 [V]
	Analog torque command gain	Sets the torque command per 1 V of analog input voltage.	0 to 300 [%]
	Analog torque command offset voltage	Sets the offset voltage for analog torque command input.	-1.00 to 1.00 [V]
	Analog input signal automatic offset	Changes the setting to enable/disable automatic offset for analog input signals.	0: Disable 1: Enable
	Analog speed monitor maximum value	Sets the maximum value of monitored analog speed. This setting determines the slope of output of monitored analog speed.	0 to 6,000 [r/min]
	Analog speed monitor maximum voltage	Sets the monitored output voltage corresponding to the maximum value of monitored analog speed.	1 to 10 [V]
	Analog speed monitor offset voltage	Sets the offset voltage for monitored analog speed.	-1.00 to 1.00 [V]
	Analog torque monitor maximum value	Sets the maximum value of monitored analog torque. This setting determines the slope of output of monitored analog torque.	1 to 300 [%]
	Analog torque monitor maximum voltage	Sets the monitored output voltage corresponding to the maximum value of monitored analog torque.	1 to 10 [V]
Analog torque monitor offset voltage	Sets the offset voltage for monitored analog torque.	-1.00 to 1.00 [V]	

MEXE02 tree view	Name	Description	Setting range
Alarm/warning	Overvoltage warning	Sets the voltage under which an overvoltage warning generates.	320 to 400 [V]
	Undervoltage warning	Sets the voltage under which an undervoltage warning generates.	120 to 280 [V]
	Overheat warning	Sets the temperature under which an overheat warning generates.	40 to 85 [°C]
	Overload warning	Sets the condition under which an overload warning generates.	1 to 100 [%]
	Overspeed warning	Sets the speed under which an overspeed warning generates.	1 to 6,000 [r/min]
Function	Deceleration rate of speed monitor	The deceleration rate can be set when the actual speed for the output shaft of the geared motor is monitored.	1.0 to 100.0
Manual operation and display	JOG operating torque	Sets the torque command for JOG operation. "100 %" indicates a value equivalent to the rated torque.	1 to 100 [%]
	Data setter speed display	Shows the speed on the OPX-2A with a sign or as an absolute value.	0: Signed 1: Absolute value
	Data setter edit	Sets whether it is possible to edit using the OPX-2A .	0: Disable 1: Enable

2-3 System parameters

MEXE02 tree view	Name	Description	Setting range
Electronic gear	Encoder output electronic gear A	Sets the denominator of the electronic gear for encoder output.	1 to 1,000
	Encoder output electronic gear B	Sets the numerator of the electronic gear for encoder output.	1 to 1,000
Operation	Analog input signals	Changes the setting to enable/disable the analog input signals.	0: Disable 1: Enable
	Motor rotation direction	Sets the direction in which motor torque generates.	0: +=CCW 1: +=CW
	Data-setter initial display	Selects the initial screen to be displayed when the OPX-2A starts communicating with the driver. If the selected item is not supported in the torque control mode, the top screen of the monitor mode is displayed as the initial display.	0: Operating speed [r/min] 1: Position [steps] 2: Torque [%] 3: Estimated inertial moment ratio [%] 4: Operation number 5: Selected number 6: Tension [%] 7: Revolution counter [rev] 8: Roll diameter [mm] 9: Top screen of monitor mode

3 Torque control operation

The motor is operated in a manner controlling its output torque at a specified level.
Follow the steps below to perform a torque controlled operation:

- Step 1 Setting the torque command value
- Step 2 Setting the motor rotation direction
- Step 3 Performing the torque controlled operation

Step 1 Setting the torque command value

Set a torque command value under each of eight operation data numbers from 0 to 7.
When the system parameter for analog input signals is set to "1: Enable," two analog points and six digital points are available to assign settings. If the parameter is set to "0: Disable," eight digital points are available to assign settings.
Set the torque limit as an integer percentage of the rated torque being 100 %, in a range of 0 to 300 %.

Operation data	Analog input signals	
	Enable (initial value)	Disable
No.0	Analog setting (internal potentiometer VR1)	Digital setting
No.1	Analog setting (External potentiometer or external DC voltage)	Digital setting
No.2 to No.7	Digital setting	

memo One set of the speed limit and the torque command can be set in the operation data No.0 to No.7 each. Use by switching an operation data according to the operating condition. Select an operation data based on a combination of the ON/OFF status of the M0 to M2 inputs.

● Initial value

Operation data	Speed limit [r/min]	Torque command [%]
No.0 to No.7	0	0

● Data selection method

Operation data	M2 input	M1 input	M0 input
No.0	OFF	OFF	OFF
No.1	OFF	OFF	ON
No.2	OFF	ON	OFF
No.3	OFF	ON	ON
No.4	ON	OFF	OFF
No.5	ON	OFF	ON
No.6	ON	ON	OFF
No.7	ON	ON	ON

■ Using the internal potentiometer VR1

1. Set the system parameter for analog input signals to "1: Enable."

memo When a system parameter has been changed, the new setting will become effective after the power is turned on again. If a 24 VDC power supply is used, also turn on the 24 VDC power supply again.

2. Turn the M0 to M2 inputs OFF and select operation data No.0.
3. Use the internal potentiometer VR1 to set the torque command value.
Setting range: 0 to 300 %
Factory setting: 0 %

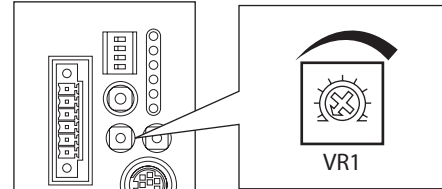

■ Using an external potentiometer or external DC voltage

1. Set the system parameter for analog input signals to "1: Enable."

memo When a system parameter has been changed, the new setting will become effective after the power is turned on again. If a 24 VDC power supply is used, also turn on the 24 VDC power supply again.

2. Turn the M0 input ON and M1 and M2 inputs OFF, and select operation data No.1.
3. Connect an external potentiometer or external DC voltage to pin No.4 to No.6 of the analog I/O connector (CN6). Refer to p.56 for details on the connection method.
4. Set the gain.
Set the torque command value per 1 V of voltage command in the application parameter for analog torque limit gain.
Setting range: 0 to 300 %
Initial value: 30 %
5. Set the offset.
If there is even a slight margin of error in the voltage value, the torque command value may not become 0 % even when the voltage command specifies 0 V (minimum value). In this case, adjust the offset using one of the two methods described below.

Automatic adjustment

- 1) Set the application parameter for analog input signal automatic offset to "1: Enable."
- 2) Input 0 V to the analog torque input terminal (pin No.5 of CN6).
- 3) Apply the offset for analog torque input using the **MEXE02** or the **OPX-2A**.

Adjustment using a parameter

- 1) Set the application parameter for analog input signal automatic offset to "0: Disable."
 - 2) Set the offset voltage in the application parameter for analog torque limit offset voltage.
6. Set the torque command value using an external potentiometer or external DC voltage.

Setting example

Setting example	Analog torque command gain	Analog torque command offset voltage	Description
①	30 %	0 V	The torque command value per 1 V of voltage command becomes 30 %.
②	10 %	0 V	The torque command value per 1 V of voltage command becomes 10 %.
③	100 %	0 V	The torque command value per 1 V of voltage command becomes 100 %.
④	30 %	1 V	The home of voltage command becomes 1 V. The gain on torque command value is the same as in example ①.

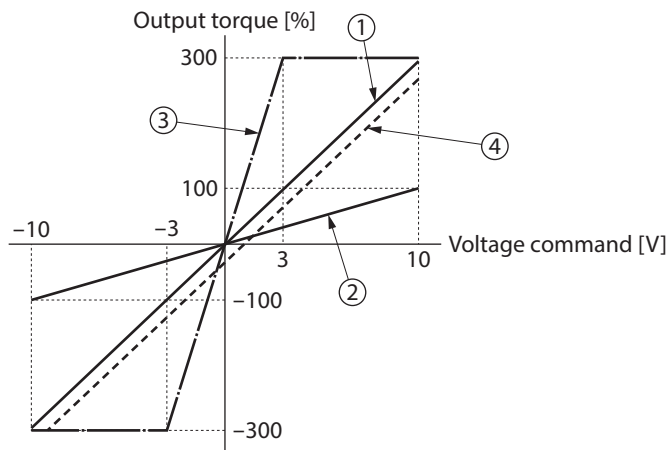

■ Digital setting

● When the analog input signals parameter is set to "1: Enable"

1. Set the system parameter for analog input signals to "1: Enable."



When a system parameter has been changed, the new setting will become effective after the power is turned on again. If a 24 VDC power supply is used, also turn on the 24 VDC power supply again.

2. Use the **MEXE02** or the **OPX-2A** to set one of operation data No.2 to No.7 as the torque command value.
3. Combine the ON/OFF statuses of M0 to M2 inputs to select one of operation data No.2 to No.7.

● When the analog input signals parameter is set to "0: Disable"

1. Set the system parameter for analog input signals to "0: Disable."



When a system parameter has been changed, the new setting will become effective after the power is turned on again. If a 24 VDC power supply is used, also turn on the 24 VDC power supply again.

2. Use the **MEXE02** or the **OPX-2A** to set one of operation data No.0 to No.7 as the torque command value.
3. Combine the ON/OFF statuses of M0 to M2 inputs to select one of operation data No.0 to No.7.

Step 2 Setting the motor rotation direction

Set a desired motor rotation direction using the system parameter for motor rotation direction.

memo When a system parameter has been changed, the new setting will become effective after the power is turned on again. If a 24 VDC power supply is used, also turn on the 24 VDC power supply again.

When the torque command is a positive value

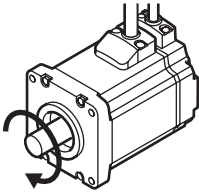
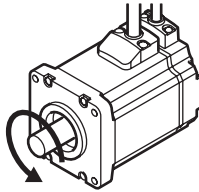
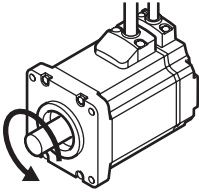
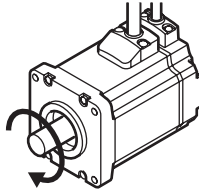
Setting of motor rotation direction parameter	CW input ON	CCW input ON
When "1: + = CW" is set	The motor rotates in CW direction. 	The motor rotates in CCW direction. 
When "0: + = CCW" is set	The motor rotates in CCW direction. 	The motor rotates in CW direction. 

If the torque command is a negative value, the rotation direction is reversed.

Step 3 Performing the torque controlled operation

1. Set the torque command value.
Analog setting: Set a desired value using the internal/external potentiometer or external DC voltage.
Digital setting: Set a desired operation data number based on a combination of ON/OFF statuses of M0 to M2 inputs.
2. Turn the CW input or CCW input ON.
Torque controlled operation starts according to the torque command value set in step 1.
3. Turn the CW input or CCW input OFF.
The motor torque drops to zero and the motor stops immediately.
Even if the CW input and CCW input are turned ON simultaneously, the torque will still drop to zero and the motor will stop immediately.

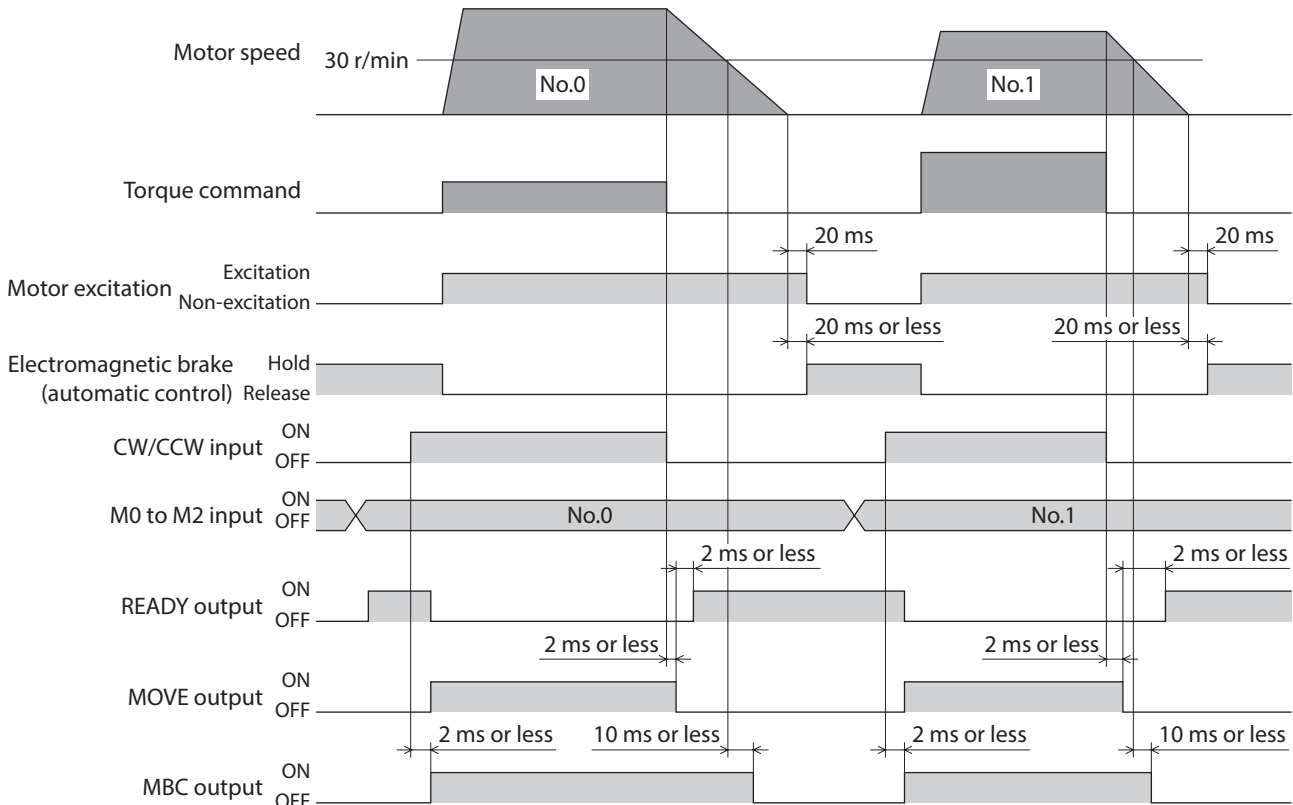

* When the CW (or CCW) input is turned OFF, the motor will remain excited for approximately 20 ms after the torque command is completed.



Since the operating speed cannot be set in the torque control mode, the motor may operate at high speed if the load is too small for the command torque.

■ Notifying that the motor is ready: READY output

When the motor becomes ready, the READY output will turn ON. Start the operation after confirming that the READY output has turned ON. The READY output remains OFF while the motor is operating.

The READY output is OFF under the following conditions. Motor operation is disabled while the READY output is OFF:

- The main power supply is cut off.
- An alarm is present.
- The FREE input, CW input or CCW input is ON.
- A remote operation is performed using **MEXE02**.
- An operation is performed on the **OPX-2A** in the test mode or copy mode.

■ Notifying that operation is in progress: MOVE output

The MOVE output can be enabled by selecting the output using the application parameter for output signal selection 1.

The MOVE output remains ON while the motor is operating. You can set the minimum time during which the MOVE output remains ON using the application parameter for minimum ON time for MOVE signal. Even in a short operation, the MOVE output will remain ON for the time set in this parameter.

Example: When 10 ms is set in the parameter for minimum ON time for MOVE signal.

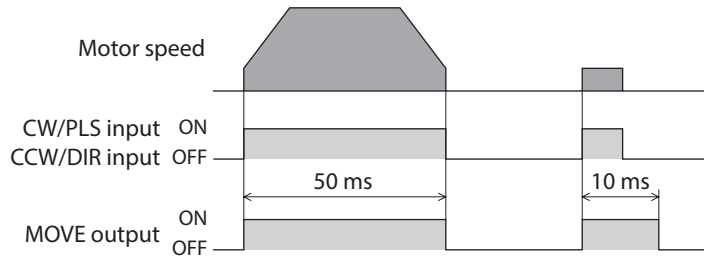

■ Notifying the timing of electromagnetic brake control: MBC output

Use the MBC output to control the electromagnetic brake using a programmable controller, etc.

The MBC output can be enabled by selecting the output using the application parameter for output signal selection 1.

The MBC output will turn ON when the electromagnetic brake is released, and turn OFF when the electromagnetic brake is actuated (= to hold the load in position). Set the programmable controller to control the electromagnetic brake by detecting the ON/OFF status of the MBC output.

■ Notifying that the detected speed has become zero: ZV output

The ZV output can be enabled by selecting the output using the application parameter for output signal selection 2.

When the detected speed drops into the zero speed output band, the ZV output will turn ON.

You can set the band within which the ZV output turns ON, using the application parameter for zero speed output band.

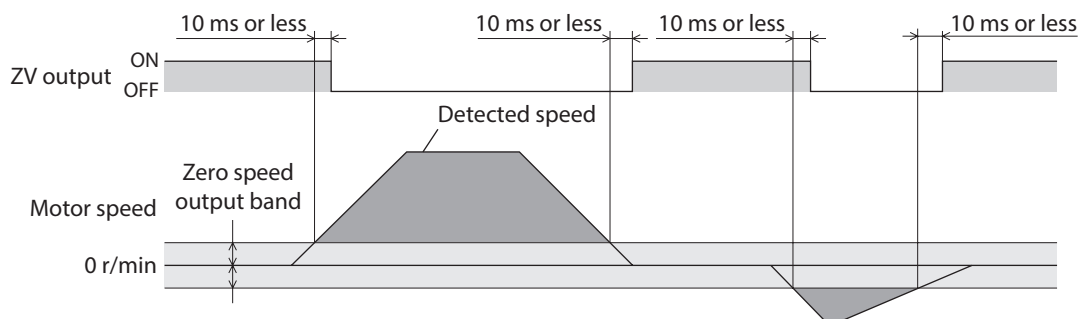

■ Notifying that the speed is being limited: VLC output

When the detected speed reaches the speed limit, the VLC output will turn ON.

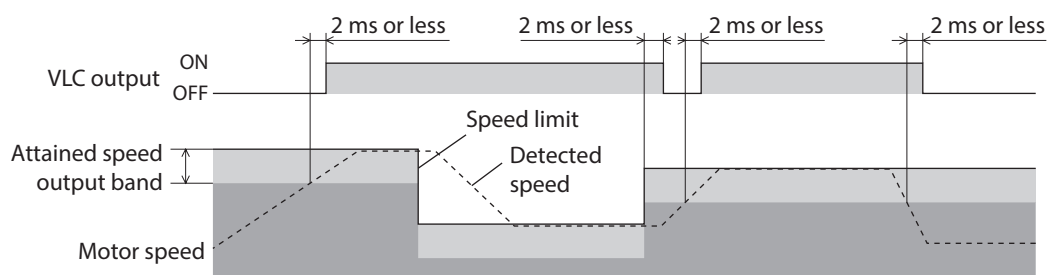

■ Freeing the motor output shaft: FREE input

When the FREE input is turned ON, the motor current will be cut off. The motor will lose its holding torque, and the output shaft can be turned with an external force.

If the FREE input is turned ON while the position is held with the electromagnetic brake, the electromagnetic brake will be released. Accordingly, the position can no longer be held.

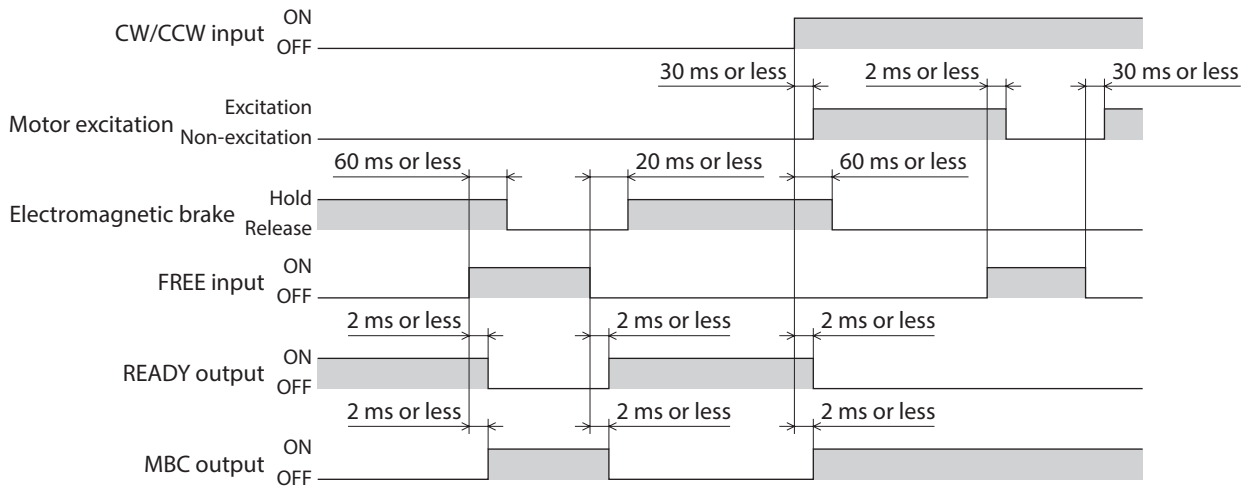

4 Speed limit

Since speed control is not performed during torque controlled operation, the motor may operate at high speed if the load is too small. To prevent this from happening, you can limit the speed of the motor operating under torque control.

Set a speed limit value under each of eight operation data numbers from 0 to 7.

When the system parameter for analog input signals is set to "1: Enable," two analog points and six digital points are available to assign settings. If the parameter is set to "0: Disable," eight digital points are available to assign settings.

Operation data	Analog input signals	
	Enable (initial value)	Disable
No.0	Analog setting (internal potentiometer VR2)	Digital setting
No.1	Analog setting (External potentiometer or external DC voltage)	Digital setting
No.2 to No.7	Digital setting	

memo One set of the speed limit and the torque command can be set in the operation data No.0 to No.7 each. Use by switching an operation data according to the operating condition. Select an operation data based on a combination of the ON/OFF status of the M0 to M2 inputs.

● Initial value

Operation data	Speed limit [r/min]	Torque command [%]
No.0 to No.7	0	0

● Data selection method

Operation data	M2 input	M1 input	M0 input
No.0	OFF	OFF	OFF
No.1	OFF	OFF	ON
No.2	OFF	ON	OFF
No.3	OFF	ON	ON
No.4	ON	OFF	OFF
No.5	ON	OFF	ON
No.6	ON	ON	OFF
No.7	ON	ON	ON

4-1 Using the internal potentiometer VR2

1. Set the system parameter for analog input signals to "1: Enable."

memo When a system parameter has been changed, the new setting will become effective after the power is turned on again. If a 24 VDC power supply is used, also turn on the 24 VDC power supply again.

2. Turn the M0 to M2 inputs OFF and select operation data No.0.
3. Set the speed limit value using the internal potentiometer VR2.
Setting range: 0 to 5,500 r/min
Factory setting: 0 r/min

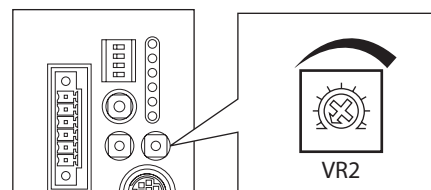

4-2 Using an external potentiometer or external DC voltage

1. Set the system parameter for analog input signals to "1: Enable."



When a system parameter has been changed, the new setting will become effective after the power is turned on again. If a 24 VDC power supply is used, also turn on the 24 VDC power supply again.

2. Turn the M0 input ON and M1 and M2 inputs OFF, and select operation data No.1.
3. Connect an external potentiometer or external DC voltage to pin No.1 to No.3 of the analog I/O connector (CN6). Refer to p.56 for details on the connection method.
4. Set the gain.
Set the speed command value per 1 V of voltage command in the application parameter for analog speed limit gain.
Setting range: 0 to 5,500 r/min
Initial value: 550 r/min
5. Set the offset.
If there is even a slight margin of error in the voltage value, the speed limit value may not become 0 r/min even when the voltage command specifies 0 V (minimum value). In this case, adjust the offset using one of the two methods described below.

Automatic adjustment

- 1) Set the application parameter for analog input signal automatic offset to "1: Enable."
- 2) Input 0 V to the analog speed input terminal (pin No.1 of CN6).
- 3) Apply the offset for analog speed input using the **MEXE02** or the **OPX-2A**.

Adjustment using a parameter

- 1) Set the application parameter for analog input signal automatic offset to "0: Disable."
- 2) Set the offset voltage in the application parameter for analog speed command offset voltage.

6. Set the speed limit value using an external potentiometer or external DC voltage.

Setting example

Setting example	Analog speed limit gain	Analog speed limit offset voltage	Description
①	550 r/min	0 V	The speed limit value per 1 V of voltage command becomes 550 r/min.
②	10 r/min	0 V	The speed limit value per 1 V of voltage command becomes 10 r/min.
③	550 r/min	1 V	The home of voltage command becomes 1 V. The gain of speed limit value is the same as in example ①.

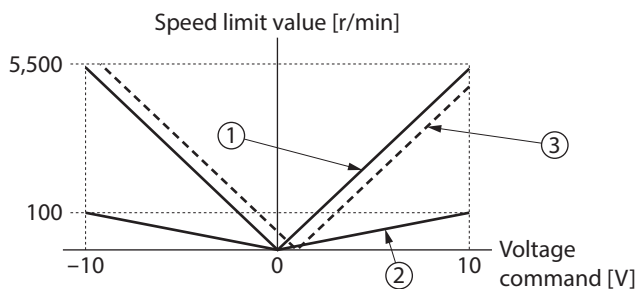

4-3 Digital setting

- **When the analog input signals parameter is set to “1: Enable”**

1. Set the system parameter for analog input signals to “1: Enable.”



When a system parameter has been changed, the new setting will become effective after the power is turned on again. If a 24 VDC power supply is used, also turn on the 24 VDC power supply again.

2. Use the **MEXE02** or the **OPX-2A** to set one of operation data No.2 to No.7 as the speed command value.
3. Combine the ON/OFF statuses of M0 to M2 inputs to select one of operation data No.2 to No.7.

- **When the analog input signals parameter is set to “0: Disable”**

1. Set the system parameter for analog input signals to “0: Disable.”



When a system parameter has been changed, the new setting will become effective after the power is turned on again. If a 24 VDC power supply is used, also turn on the 24 VDC power supply again.

2. Use the **MEXE02** or the **OPX-2A** to set one of operation data No.0 to No.7 as the speed command value.
3. Combine the ON/OFF statuses of M0 to M2 inputs to select one of operation data No.0 to No.7.

6 Tension control mode

This part explains the functions and operation of the tension control mode.

◆ Table of contents

1	Guidance	134
2	List of setting items.....	136
	2-1 Operation data	136
	2-2 Application parameters.....	136
	2-3 System parameters	138
3	Selecting the operation mode	139
4	Tension controlled operation (simple mode)	140
5	Tension control operation (high function mode I, high function mode II).....	145
6	Timing chart	152
7	Speed limit.....	156
	7-1 Using the internal potentiometer VR2..	157
	7-2 Using an external potentiometer or external DC voltage	157
	7-3 Digital setting.....	158

1 Guidance

When winding a roll of film, paper, etc., the diameter of material is different between the start and end of winding. Therefore, the torque must be changed according to the changing diameter to keep the tension at a constant level. This type of control is possible in the tension control mode.

If you are new to the **NX** Series driver, read this section to understand the operating methods along with the operation flow.



Before operating the motor, check the condition of the surrounding area to ensure safety.

STEP 1 Check the installation and connection

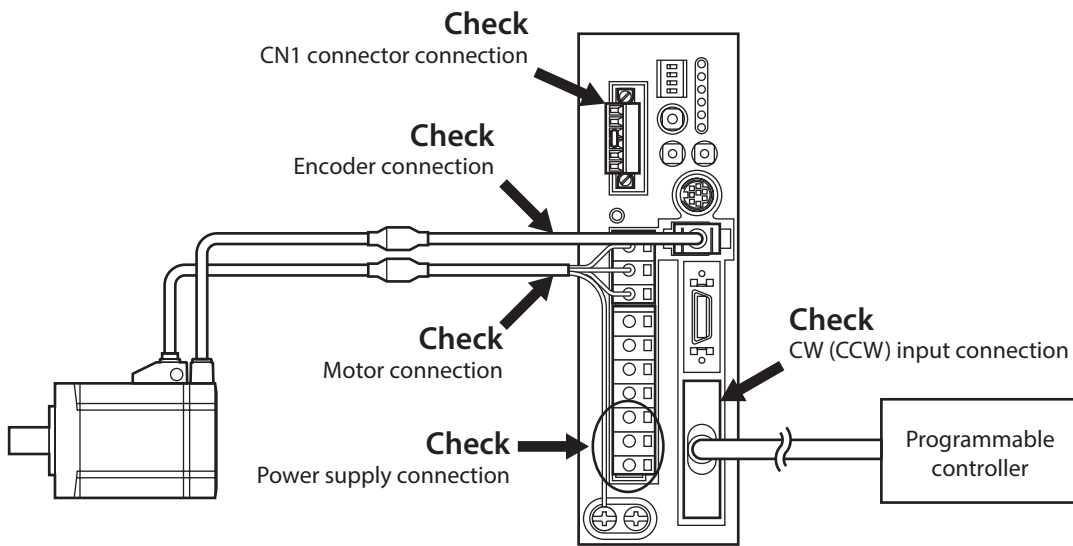

STEP 2 Operate the motor

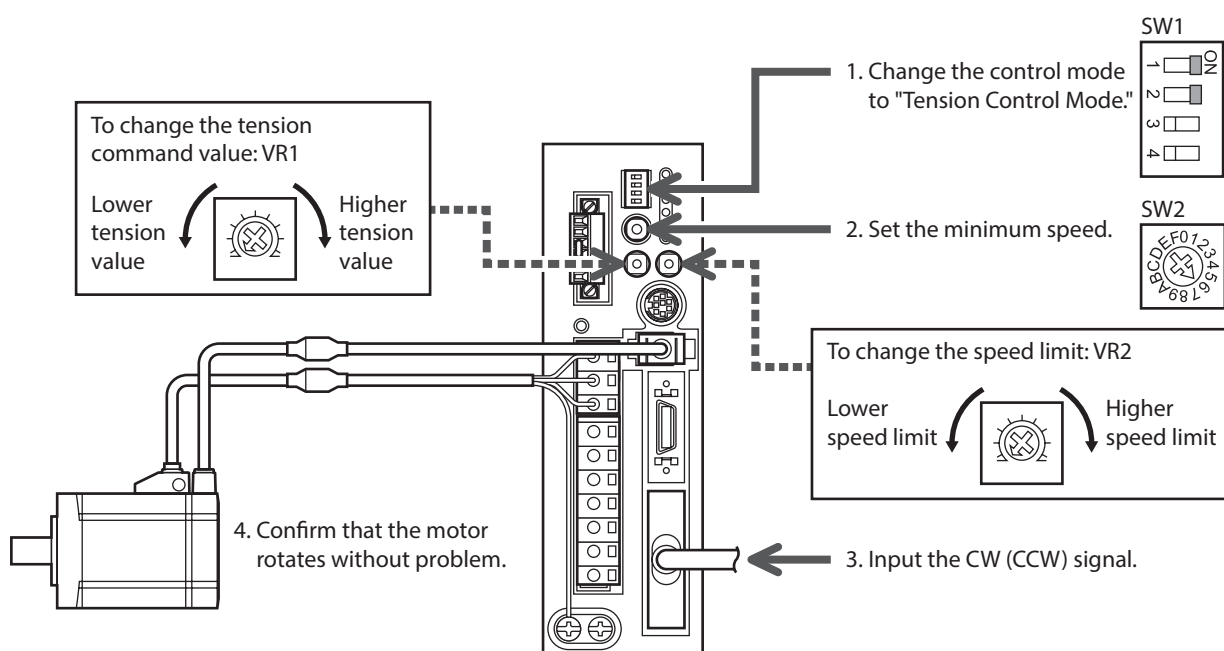

The new settings of the control mode setting switches will become effective after the power is turned on again. If a 24 VDC power supply is used, also turn on the 24 VDC power supply again.

STEP 3 Were you able to operate the motor properly?

How did it go? Were you able to operate the motor properly?

If the motor does not function, check the following points:

- Are the thermal terminals for regeneration resistor (TH1 and TH2) on the CN1 (shorted)?
- Is any alarm present?
- Are the power supply and motor connected securely?
- Is the TEN LED (green) lit?
- Isn't the VR2 set to 0 r/min?

For more detailed settings and functions, refer to the following pages.

2 List of setting items

The items that can be set in the tension control mode are listed below.

You can use the **MEXE02** or the **OPX-2A** to set operation data or change the internal parameters of the driver.

2-1 Operation data

Item	Description	Setting range
Speed limit	Sets the speed limit value.	0 to 5,500 [r/min]
Tension command	Sets the tension command. The rated torque corresponds to 100 %.	0 to 100 [%]
Material thickness *1 *2	Sets the thickness of material.	1 to 5,000 [μm]
Initial diameter *1 *2	Sets the initial diameter when winding or unwinding.	1 to 1,000 [mm]
Final diameter *1 *2	Sets the final diameter when winding or unwinding.	1 to 1,000 [mm]
Taper setting *1 *2	This function prevents excessively tight winding. As the roll diameter increases, the tension is lowered. The tension becomes constant when the taper setting is 100 %.	0 to 100 [%]
Material inertial moment *2	Sets the inertial moment of the material at the maximum material thickness.	0.00 to 99,999.99 [$\times 10^{-4} \text{ kgm}^2$]
Core inertial moment *2	Sets the inertial moment of the core.	0.00 to 99,999.99 [$\times 10^{-4} \text{ kgm}^2$]

*1 This parameter is set in high function mode I.

*2 This parameter is set in high function mode II.

2-2 Application parameters

MEXE02 tree view	Name	Description	Setting range
I/O	Output signal selection 1	Selects the output signal.	0: WNG output 1: MOVE output 2: MBC output
	Output signal selection 2	Selects the output signal.	0: ZSG2 output 1: ZV output
	Zero speed output band	Sets the output condition for ZV output.	1 to 5,500 [r/min]
	Minimum ON time for MOVE signal	Sets the minimum ON time for MOVE output.	0 to 255 [ms]
	Alarm code output	Changes the setting to enable/disable alarm code output.	0: Disable 1: Enable
Analog	Analog speed limit gain	Sets the speed limit per 1 V of analog input voltage.	0 to 5,500 [r/min]
	Analog speed limit offset voltage	Sets the offset voltage for analog speed limit input.	-1.00 to 1.00 [V]
	Analog tension command gain	Sets the tension command per 1 V of analog input voltage.	0 to 100 [%]
	Analog tension command offset voltage	Sets the offset voltage for analog tension command input.	-1.00 to 1.00 [V]
	Analog input signal automatic offset	Changes the setting to enable/disable automatic offset for analog input signals.	0: Disable 1: Enable
	Analog speed monitor maximum value	Sets the maximum value of monitored analog speed. This setting determines the slope of output of monitored analog speed.	1 to 6,000 [r/min]
	Analog speed monitor maximum voltage	Sets the monitored output voltage corresponding to the maximum value of monitored analog speed.	1 to 10 [V]

MEXE02 tree view	Name	Description	Setting range
Analog	Analog speed monitor offset voltage	Sets the offset voltage for monitored analog speed.	–1.00 to 1.00 [V]
	Analog torque monitor maximum value	Sets the maximum value of monitored analog torque. This setting determines the slope of output of monitored analog torque.	1 to 300 [%]
	Analog torque monitor maximum voltage	Sets the monitored output voltage corresponding to the maximum value of monitored analog torque.	1 to 10 [V]
	Analog torque monitor offset voltage	Sets the offset voltage for monitored analog torque.	–1.00 to 1.00 [V]
Alarm/warning	Overvoltage warning	Sets the voltage under which an overvoltage warning generates.	320 to 400 [V]
	Undervoltage warning	Sets the voltage under which an undervoltage warning generates.	120 to 280 [V]
	Overheat warning	Sets the temperature under which an overheat warning generates.	40 to 85 [°C]
	Overload warning	Sets the condition under which an overload warning generates.	1 to 100 [%]
	Overspeed warning	Sets the speed under which an overspeed warning generates.	1 to 6,000 [r/min]
Function	Acceleration/deceleration correction filter	Sets the correction filter time constant for acceleration/ deceleration. Increase the value if vibration occurs when the motor accelerates/ decelerates during winding operation.	10 to 500 [ms]
	Friction torque correction	Sets the friction torque correction. This parameter corrects the torque load based on the friction of mechanical parts. The value is based on the torque detected during idle operation.	0 to 50 [%]
	Deceleration rate of speed monitor	The deceleration rate can be set when the actual speed for the output shaft of the geared motor is monitored.	1.0 to 100.0
Manual operation and display	JOG operating tension	Sets the tension command for JOG operation. "100 %" indicates a value equivalent to the rated torque.	1 to 100 [%]
	Data setter speed display	Shows the speed on the OPX-2A with a sign or as an absolute value.	0: Signed 1: Absolute value
	Data setter edit	Sets whether it is possible to edit using the OPX-2A .	0: Disable 1: Enable

2-3 System parameters

MEXE02 tree view	Name	Description	Setting range
Electronic gear	Encoder output electronic gear A	Sets the denominator of the electronic gear for encoder output.	1 to 1,000
	Encoder output electronic gear B	Sets the numerator of the electronic gear for encoder output.	1 to 1,000
Operation	Tension control mode selection	Sets the operation mode.	0: Simple 1: High function I 2: High function II
	Deceleration rate of tension control	Sets the gear ratio between the motor shaft and winding shaft.	1.0 to 1,000.0
	Analog input signals	Changes the setting to enable/disable the analog input signals.	0: Disable 1: Enable
	Motor rotation direction	Sets the direction in which motor torque generates.	0: +=CCW 1: +=CW
	Data-setter initial display	Selects the initial screen to be displayed when the OPX-2A starts communicating with the driver. If the selected item is not supported in the tension control mode, the top screen of the monitor mode is displayed as the initial display.	0: Operating speed [r/min] 1: Position [steps] 2: Torque [%] 3: Estimated inertial moment ratio [%] 4: Operation number 5: Selected number 6: Tension [%] 7: Revolution counter [rev] 8: Roll diameter [mm] 9: Top screen of monitor mode

3 Selecting the operation mode

Three operation modes are available in the tension control mode. Set a desired operation mode in the system parameter for tension control mode selection.

Mode type	Description
Simple (initial value)	The tension is controlled at a constant level when the feed rate is constant during winding operation, etc. The motor speed is inversely proportional to the torque.
High function I	The current winding (unwinding) diameter is calculated automatically based on the initial diameter, material thickness and final diameter. The tension is controlled at a constant level regardless of the operating speed.
High function II	In addition to the control in high function mode I, the load inertial moment is calculated internally by the driver based on the material inertial moment and core inertial moment. The tension is controlled at a constant level even during acceleration/deceleration.



When a system parameter has been changed, the new setting will become effective after the power is turned on again. If a 24 VDC power supply is used, also turn on the 24 VDC power supply again.

The operation data items that can be set vary depending on the selected mode.

Set the operation data of the high function mode I and the high function mode II using the **MEXE02** or the **OPX-2A**.

Setting item	Tension mode		
	Simple	High function I	High function II
Tension command value	Available	Available	Available
Material thickness	Not available	Available	Available
Initial diameter	Not available	Available	Available
Final diameter	Not available	Available	Available
Material inertial moment	Not available	Not available	Available
Core inertial moment	Not available	Not available	Available
Taper setting	Not available	Available	Available
Speed limit	Available	Available	Available

4 Tension controlled operation (simple mode)

Follow the steps below to perform a tension controlled operation:

- Step 1 Calculating the tension command value
- Step 2 Setting the tension command value
- Step 3 Setting the motor rotation direction
- Step 4 Performing the tension controlled operation

Step 1 Calculating the tension command value

In the simple mode, the operating speed of the motor is inversely proportional to the generated torque. Calculate the tension command value based on the operating speed and torque, by using the formula below:

$$\text{Tension command value [\%]} = \frac{(2) \text{ Maximum required torque [N}\cdot\text{m]} \times 100}{\text{Rated motor torque [N}\cdot\text{m]}} \times \frac{(1) \text{ Operating speed [r/min]}}{(3) \text{ Minimum speed [r/min]}}$$

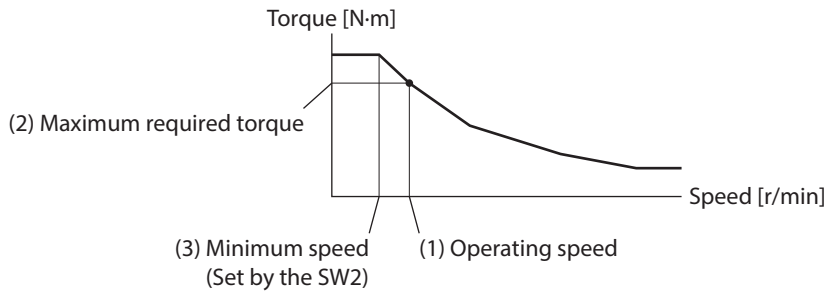

- 1) Operating speedThe lowest winding speed (corresponding to the maximum roll diameter)
- 2) Maximum required torque.....Calculate an appropriate value according to the mechanism of your equipment.
- 3) Minimum speedSet by the SW2. Find an approximate value of operating speed (1) from the table below. Note that the minimum speed must be smaller than the operating speed. Example: If the operating speed is 24 r/min, the minimum speed should be the value corresponding to dial setting 2 (22 r/min).

SW2 dial setting	Minimum speed [r/min]
0	10
1	15
2	22
3	33
4	47
5	68
6	100
7	150

SW2 dial setting	Minimum speed [r/min]
8	220
9	330
A	470
B	680
C	1,000
D	1,500
E	2,200
F	3,000

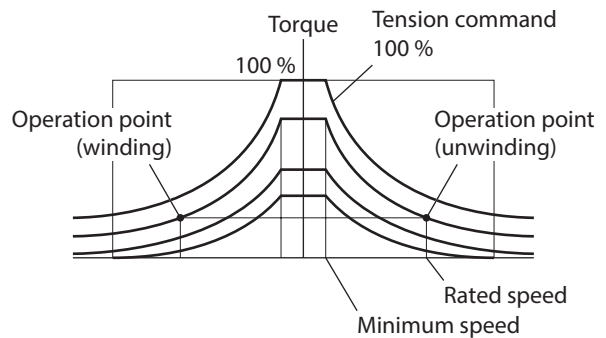

Note In the simple mode, keep constant the rate of material feed set by the feed roller, etc. If the feed rate changes, the tension cannot be kept constant.

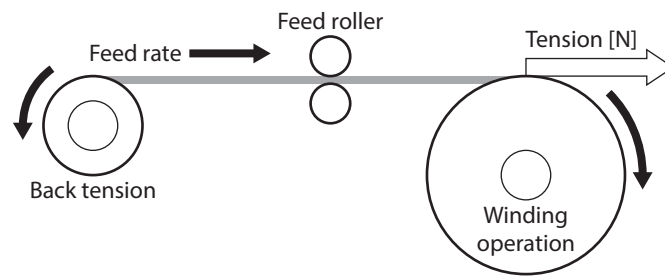

Step 2 Setting the tension command value

Set a tension command value calculated per Step 1 under each of eight operation data numbers from 0 to 7. When the system parameter for analog input signals is set to "1: Enable," two analog points and six digital points are available to assign settings. If the parameter is set to "0: Disable," eight digital points are available to assign settings.

Operation data	Analog input signals	
	Enable (initial value)	Disable
No.0	Analog setting (internal potentiometer VR1)	Digital setting
No.1	Analog setting (External potentiometer or external DC voltage)	Digital setting
No.2 to No.7	Digital setting	

memo One set of the speed limit, the tension command, the material thickness, the initial diameter, the final diameter, the taper setting, the material inertial moment, and the core inertial moment can be set in the operation data No.0 to No.7 each. Use by switching an operation data according to the operating condition. Select an operation data based on a combination of the ON/OFF status of the M0 to M2 inputs.

● Initial value

Operation data	Speed limit [r/min]	Tension command [%]	Material thickness [μm]	Initial diameter [mm]	Final diameter [mm]	Taper setting [%]	Material inertial moment [$\times 10^{-4} \text{kgm}^2$]	Core inertial moment [$\times 10^{-4} \text{kgm}^2$]
No.0 to No.7	0	0	50	500	1,000	100	0	0

● Data selection method

Operation data	M2 input	M1 input	M0 input
No.0	OFF	OFF	OFF
No.1	OFF	OFF	ON
No.2	OFF	ON	OFF
No.3	OFF	ON	ON
No.4	ON	OFF	OFF
No.5	ON	OFF	ON
No.6	ON	ON	OFF
No.7	ON	ON	ON

■ Using the internal potentiometer VR1

1. Set the system parameter for analog input signals to "1: Enable."

memo When a system parameter has been changed, the new setting will become effective after the power is turned on again. If a 24 VDC power supply is used, also turn on the 24 VDC power supply again.

2. Turn the M0 to M2 inputs OFF and select operation data No.0.
3. Set the tension command value using the internal potentiometer VR1.
Setting range: 0 to 100 %
Factory setting: 0 %

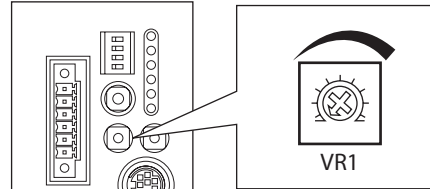

■ Using an external potentiometer or external DC voltage

1. Set the system parameter for analog input signals to "1: Enable."

memo When a system parameter has been changed, the new setting will become effective after the power is turned on again. If a 24 VDC power supply is used, also turn on the 24 VDC power supply again.

2. Turn the M0 input ON and M1 and M2 inputs OFF, and select operation data No.1.
3. Connect an external potentiometer or external DC voltage to pin No.4 to No.6 of the analog I/O connector (CN6). Refer to p.56 for details on the connection method.
4. Set the gain.
Set the tension command value per 1 V of voltage command in the application parameter for analog tension command gain.
Setting range: 0 to 100 %
Initial value: 10 %
5. Set the offset.
If there is even a slight margin of error in the voltage value, the tension command value may not become 0 % even when the voltage command specifies 0 V (minimum value). In this case, adjust the offset using one of the two methods described below.

Automatic adjustment

- 1) Set the application parameter for analog input signal automatic offset to "1: Enable."
- 2) Input 0 V to the analog torque input terminal (pin No.5 of CN6).
- 3) Apply the offset for analog torque input using the **MEXE02** or the **OPX-2A**.

Adjustment using a parameter

- 1) Set the application parameter for analog input signal automatic offset to "0: Disable."
- 2) Set the offset voltage in the application parameter for analog tension command offset voltage.

6. Set the tension command value using an external potentiometer or external DC voltage.

Setting example

Setting example	Analog tension command gain	Analog tension command offset voltage	Description
①	10 %	0 V	The tension command value per 1 V of voltage command becomes 10 %.
②	1 %	0 V	The tension command value per 1 V of voltage command becomes 1 %.
③	100 %	0 V	The tension command value per 1 V of voltage command becomes 100 %.
④	10 %	1 V	The home of voltage command becomes 1 V. The gain on tension command value is the same as in example ①.

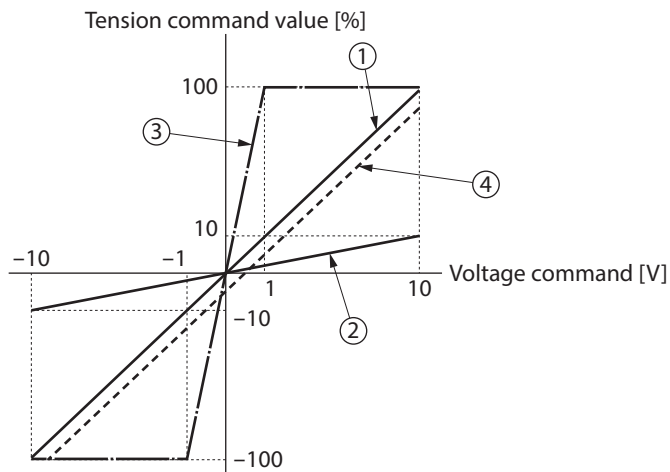

■ Digital setting

● When the analog input signals parameter is set to "1: Enable"

1. Set the system parameter for analog input signals to "1: Enable."



When a system parameter has been changed, the new setting will become effective after the power is turned on again. If a 24 VDC power supply is used, also turn on the 24 VDC power supply again.

2. Use the **MEXE02** or the **OPX-2A** to set one of operation data No.2 to No.7 as the tension command value.
3. Combine the ON/OFF statuses of M0 to M2 inputs to select one of operation data No.2 to No.7.

● When the analog input signals parameter is set to "0: Disable"

1. Set the system parameter for analog input signals to "0: Disable."



When a system parameter has been changed, the new setting will become effective after the power is turned on again. If a 24 VDC power supply is used, also turn on the 24 VDC power supply again.

2. Use the **MEXE02** or the **OPX-2A** to set one of operation data No.0 to No.7 as the tension command value.
3. Combine the ON/OFF statuses of M0 to M2 inputs to select one of operation data No.0 to No.7.

Step 3 Setting the motor rotation direction

Set a desired motor rotation direction using the system parameter for motor rotation direction.

memo When a system parameter has been changed, the new setting will become effective after the power is turned on again. If a 24 VDC power supply is used, also turn on the 24 VDC power supply again.

When the tension command is a positive value

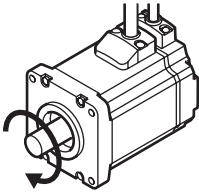
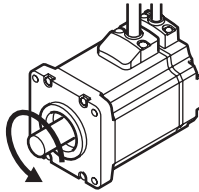
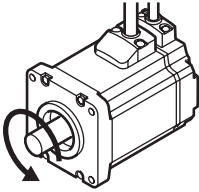
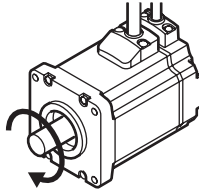
Setting of motor rotation direction parameter	CW input ON	CCW input ON *
When "1: + = CW" is set	The motor rotates in CW direction. 	The motor rotates in CCW direction. 
When "0: + = CCW" is set	The motor rotates in CCW direction. 	The motor rotates in CW direction. 

* The CCW input is not used in high function mode I and high function mode II.

If the tension command is a negative value, the rotation direction is reversed.

Step 4 Performing the tension controlled operation

- Set the tension command value.
Analog setting: Set a desired value using the internal/external potentiometer or external DC voltage.
Digital setting: Set a desired operation data number based on a combination of ON/OFF statuses of M0 to M2 inputs.
- Turn the CW input or CCW input ON.
Tension controlled operation starts according to the speed command value set in step 1.

memo Operation data numbers cannot be changed when the CW input or CCW input is ON.

- Turn the CW input or CCW input OFF.
The motor decelerates to a stop.
The time until the motor stops after it starts decelerating varies depending on the tension command value or the load condition.
Refer to p.152 for the timing chart.

5 Tension control operation (high function mode I, high function mode II)

Follow the steps below to perform a tension controlled operation:

- Step 1 Calculating the tension command value
- Step 2 Setting the tension command value
- Step 3 Setting the initial diameter, material thickness and final diameter
- Step 4 Setting the material inertial moment and core inertial moment (high function mode II only)
- Step 5 Setting the taper
- Step 6 Performing the tension controlled operation
- Step 7 Setting the parameters

Set the operation data of the high function mode I and the high function mode II using the **MEXE02** or the **OPX-2A**.

Step 1 Calculating the tension command value

Calculate the required motor torque based on the tension and maximum diameter needed for your equipment, by using the formula below:

$$\text{Required motor torque [N·m]} = \text{Tension [N]} \times \text{Maximum diameter [m]} / 2$$

Based on the calculated required motor torque, calculate the tension command value by using the formula below:

$$\text{Tension command value [\%]} = \frac{\text{Required motor torque [N·m]}}{\text{Rated motor torque [N·m]}} \times 100$$

- **Example: When the tension is 0.32 N, maximum diameter is 1 m (3.3 ft.) and applicable motor is NX620AA-1 (rated torque: 0.64 N·m)**

$$\text{Required motor torque [N·m]} = 0.32 \text{ [N]} \times \frac{1 \text{ [m]}}{2} = 0.16 \text{ [N·m]}$$

$$\text{Tension command value [\%]} = \frac{0.16 \text{ [N·m]}}{0.64 \text{ [N·m]}} \times 100 = 25 \text{ [\%]}$$

- **Example: When the winding diameter is 1,000 mm (39.37 in.)**

Tension command value [%]	Motor output	
	Torque [N·m]	Tension [N]
100	0.64	1.27
80	0.51	1.02
60	0.38	0.76
40	0.25	0.51
20	0.13	0.25
0	0	0

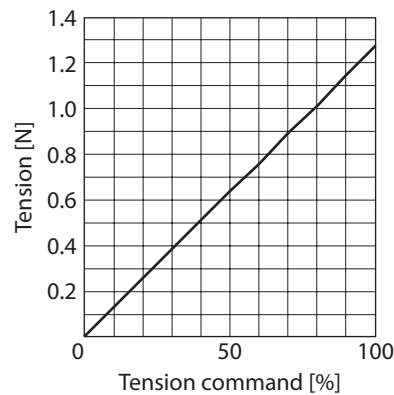

Step 2 Setting the tension command value

Set a tension command value under each of eight operation data numbers from 0 to 7.

When the system parameter for analog input signals is set to "1: Enable," two analog points and six digital points are available to assign settings. If the parameter is set to "0: Disable," eight digital points are available to assign settings.

Operation data	Analog input signals	
	Enable (initial value)	Disable
No.0	Analog setting (internal potentiometer VR1)	Digital setting
No.1	Analog setting (External potentiometer or external DC voltage)	Digital setting
No.2 to No.7	Digital setting	



One set of the speed limit, the tension command, the material thickness, the initial diameter, the final diameter, the taper setting, the material inertial moment, and the core inertial moment can be set in the operation data No.0 to No.7 each. Use by switching an operation data according to the operating condition. Select an operation data based on a combination of the ON/OFF status of the M0 to M2 inputs.

* High function mode I: Initial diameter, material thickness, final diameter (p.149), taper (p.150), speed limit value (p.156)
High function mode II: Initial diameter, material thickness, final diameter (p.149), material inertial moment, core inertial moment (p.149), taper (p.150), speed limit value (p.156)

● Initial value

Operation data	Speed limit [r/min]	Tension command [%]	Material thickness [μm]	Initial diameter [mm]	Final diameter [mm]	Taper setting [%]	Material inertial moment [$\times 10^{-4} \text{kgm}^2$]	Core inertial moment [$\times 10^{-4} \text{kgm}^2$]
No.0 to No.7	0	0	50	500	1,000	100	0	0

● Data selection method

Operation data	M2 input	M1 input	M0 input
No.0	OFF	OFF	OFF
No.1	OFF	OFF	ON
No.2	OFF	ON	OFF
No.3	OFF	ON	ON
No.4	ON	OFF	OFF
No.5	ON	OFF	ON
No.6	ON	ON	OFF
No.7	ON	ON	ON

■ Using the internal potentiometer VR1

1. Set the system parameter for analog input signals to "1: Enable."



When a system parameter has been changed, the new setting will become effective after the power is turned on again. If a 24 VDC power supply is used, also turn on the 24 VDC power supply again.

2. Turn the M0 to M2 inputs OFF and select operation data No.0.
3. Set the tension command value using the internal potentiometer VR1.
Setting range: 0 to 100 %
Factory setting: 0 %

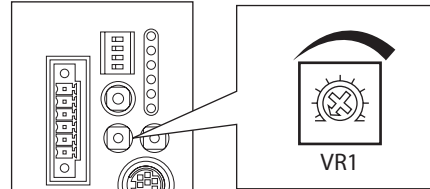

■ Using an external potentiometer or external DC voltage

1. Set the system parameter for analog input signals to "1: Enable."



When a system parameter has been changed, the new setting will become effective after the power is turned on again. If a 24 VDC power supply is used, also turn on the 24 VDC power supply again.

2. Turn the M0 input ON and M1 and M2 inputs OFF, and select operation data No.1.
3. Connect an external potentiometer or external DC voltage to pin No.4 to No.6 of the analog I/O connector (CN6). Refer to p.56 for details on the connection method.
4. Set the gain.
Set the tension command value per 1 V of voltage command in the application parameter for analog tension command gain.
Setting range: 0 to 100 %
Initial value: 10 %
5. Set the offset.
If there is even a slight margin of error in the voltage value, the tension command value may not become 0 % even when the voltage command specifies 0 V (minimum value). In this case, adjust the offset using one of the two methods described below.

Automatic adjustment

- 1) Set the application parameter for analog input signal automatic offset to "1: Enable."
- 2) Input 0 V to the analog torque input terminal (pin No.5 of CN6).
- 3) Apply the offset for analog torque input using the **MEXE02** or the **OPX-2A**.

Adjustment using a parameter

- 1) Set the application parameter for analog input signal automatic offset to "0: Disable."
 - 2) Set the offset voltage in the application parameter for analog tension command offset voltage.
6. Set the tension command value using an external potentiometer or external DC voltage.

Setting example

Setting example	Analog tension command gain	Analog tension command offset voltage	Description
①	10 %	0 V	The tension command value per 1 V of voltage command becomes 10 %.
②	1 %	0 V	The tension command value per 1 V of voltage command becomes 1 %.
③	100 %	0 V	The tension command value per 1 V of voltage command becomes 100 %.
④	10 %	1 V	The home of voltage command becomes 1 V. The gain on tension command value is the same as in example ①.

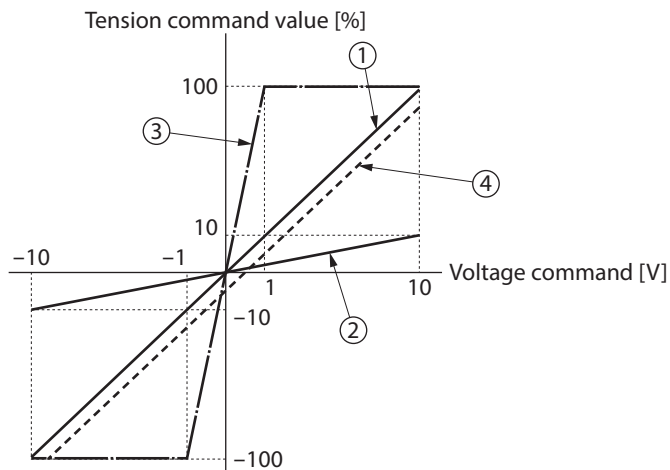

■ Digital setting

● When the analog input signals parameter is set to "1: Enable"

1. Set the system parameter for analog input signals to "1: Enable."

memo When a system parameter has been changed, the new setting will become effective after the power is turned on again. If a 24 VDC power supply is used, also turn on the 24 VDC power supply again.

2. Use the **MEXE02** or the **OPX-2A** to set one of operation data No.2 to No.7 as the tension command value.
3. Combine the ON/OFF statuses of M0 to M2 inputs to select one of operation data No.2 to No.7.

● When the analog input signals parameter is set to "0: Disable"

1. Set the system parameter for analog input signals to "0: Disable."

memo When a system parameter has been changed, the new setting will become effective after the power is turned on again. If a 24 VDC power supply is used, also turn on the 24 VDC power supply again.

2. Use the **MEXE02** or the **OPX-2A** to set one of operation data No.0 to No.7 as the tension command value.
3. Combine the ON/OFF statuses of M0 to M2 inputs to select one of operation data No.0 to No.7.

Step 3 Setting the initial diameter, material thickness and final diameter

In high function mode I or high function mode II, set an initial diameter, material thickness and final diameter under each of operation data numbers from 0 to 7.

Select desired data from among the predefined settings, based on a combination of ON/OFF statuses of M0 to M2 inputs.

When the initial diameter is smaller than the final diameter, winding operation is performed.

When the initial diameter is greater than the final diameter, unwinding operation is performed.

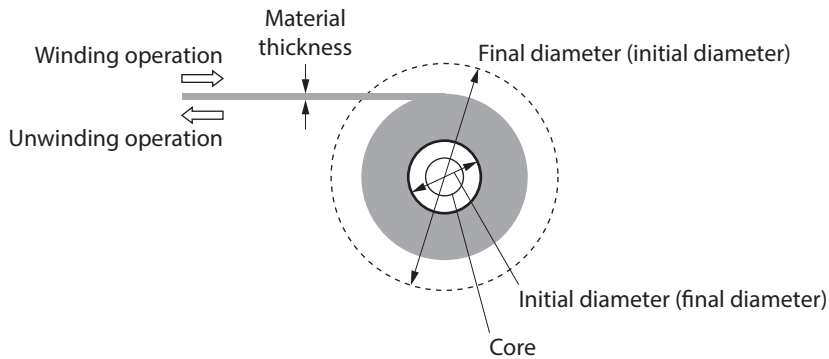

Item	Initial value	Setting range	Description
Material thickness	50	1 to 5,000 [μm]	Sets the thickness of material.
Initial diameter	500	1 to 1,000 [mm]	Sets the initial diameter when winding or unwinding.
Final diameter	1,000	1 to 1,000 [mm]	Sets the final diameter when winding or unwinding.

Step 4 Setting the material inertial moment and core inertial moment (high function mode II only)

In high function mode II, set a material inertial moment and core inertial moment under each of operation data numbers from 0 to 7.

Select desired data from among the predefined settings, based on a combination of ON/OFF statuses of M0 to M2 inputs.

As the material inertial moment, set the value of inertial moment corresponding to the maximum diameter. (The maximum diameter is the final diameter in the case of winding operation, or initial diameter in the case of unwinding operation.)

Do not include the core inertial moment in the material inertial moment.

Item	Initial value	Setting range	Description
Core inertial moment	0	0.00 to 99,999.99 [$\times 10^{-4} \text{ kgm}^2$]	Sets the inertial moment of the core.
Material inertial moment	0	0.00 to 99,999.99 [$\times 10^{-4} \text{ kgm}^2$]	Sets the inertial moment of the material at the maximum material thickness.

Step 5 Setting the taper

Continuing to wind under constant tension may cause the material to deform due to tight winding. To prevent tight winding, reduce the tension applied on the material as the winding diameter increases.

Set a tension (%) at the maximum diameter under each of operation data numbers from 0 to 7.

Select desired data from among the predefined settings, based on a combination of ON/OFF statuses of M0 to M2 inputs.

When the taper is 100 %, the tension remains constant during the operation.

Setting range: 0 to 100 %

Initial value: 100 %

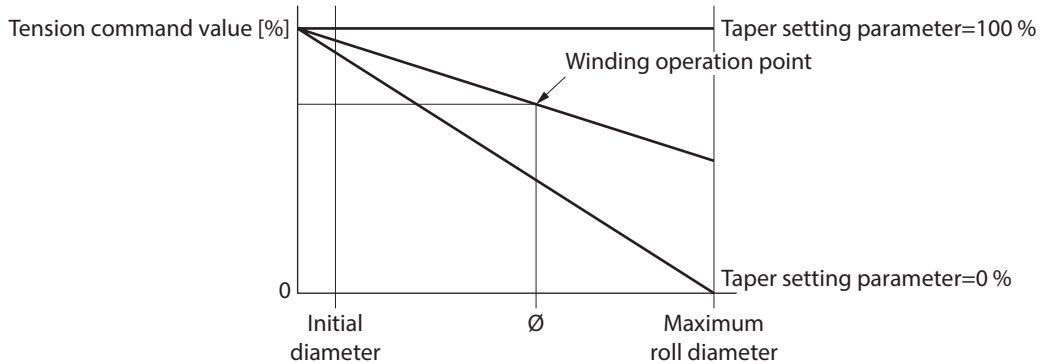

When the roll diameter is "0," the tension command value is used. Once the roll diameter reaches the maximum diameter, the taper setting will be applied to the tension command value.

Example: When the tension command value is set to 80 % and taper setting to 50 %

When the roll diameter is "0," the tension command value is 80 %.

Once the roll diameter reaches the maximum diameter, the tension command value will be adjusted to 40 % (80 % × 50 %). The tension command value traces a straight line connecting these two values between the point where the roll diameter is "0" and the point where it corresponds to the maximum diameter.

The roll diameter never becomes zero because the core diameter is always included as part of the roll diameter. The tension controlled operation, practically, starts from the "initial diameter" position as shown in the graph above.

If the taper setting is a value other than 100 %, the taper is applied to the tension command value from the beginning when the roll diameter is equal to the initial diameter.

If the taper setting is 100 %, the tension command value remains the specified value throughout the operation.

Step 6 Performing the tension controlled operation

1. Set the tension command value.
Analog setting: Set a desired value using the internal/external potentiometer or external DC voltage.
Digital setting: Set a desired operation data number based on a combination of ON/OFF statuses of M0 to M2 inputs.
2. Set the direction in which tension generates in the system parameter for motor rotation direction.
3. Turn the CW input ON.
Tension controlled operation starts at the tension command value set in step 1.



- The CCW input is not accepted in high function mode I or high function mode II.
- Operation data numbers cannot be changed when the CW input is ON.

4. Turn the CW input OFF.
The motor decelerates to a stop.
The time until the motor stops after it starts decelerating varies depending on the tension command value or the load condition.
Refer to p.152 for the timing chart.

Step 7 Setting the parameters

Set the following parameters as necessary.

■ Friction torque correction

Correct the torque load based on the friction of mechanical parts. Set the output torque during idle operation of the equipment in the application parameter for frictional torque correction. The value based on the output torque during idle operation can be monitored by the **MEXE02** or the **OPX-2A**.

Setting range: 0 to 50 %

Initial value: 0 %

■ Tension control gear ratio

When a deceleration mechanism is used between the motor output shaft and winding (or unwinding) shaft, set a gear ratio in the system parameter for tension control gear ratio. When using the geared motor, include the gear ratio of such geared motor as well.

Setting range: 1.0 to 1,000.0

Initial value: 1.0



When a system parameter has been changed, the new setting will become effective after the power is turned on again. If a 24 VDC power supply is used, also turn on the 24 VDC power supply again.

■ Acceleration/deceleration correction filter (high function mode II only)

Set the correction filter time constant for acceleration/deceleration in the application parameter for acceleration/deceleration correction filter. Increase the value if vibration occurs when the motor is operating.

Setting range: 10 to 500 ms

Initial value: 100 ms

6 Timing chart

■ Winding operation

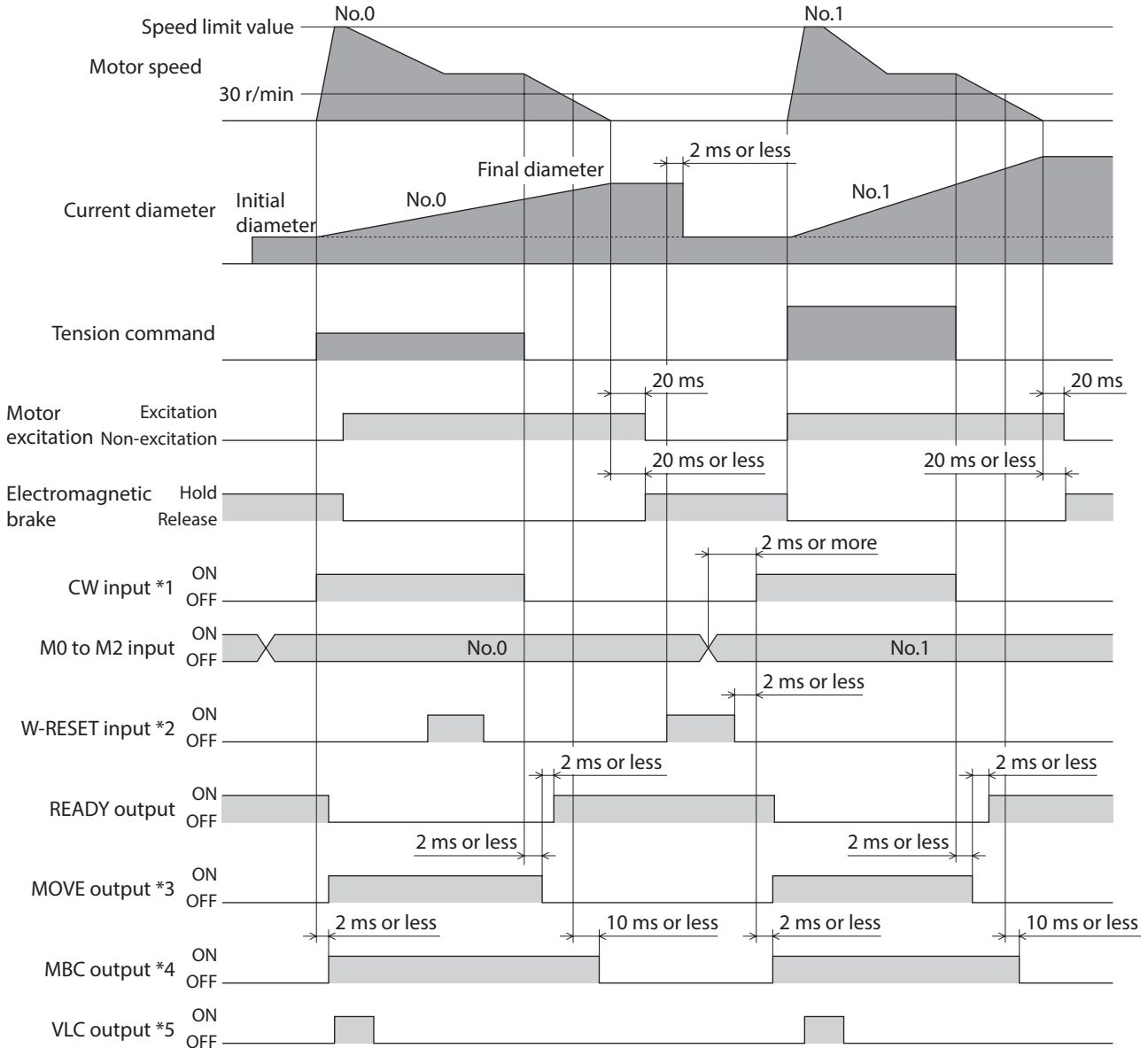

6 Tension control mode

- *1 The direction in which the motor rotates when the CW input turns ON can be set in the system parameter for motor rotation direction. The CCW input is not used in high function mode I or high function mode II. In these modes, set the direction in the motor rotation direction parameter.
- *2 Turning the W-RESET input ON during operation will not trigger a reset.
- *3 If the MOVE output is to be used, select the output in the application parameter for output signal selection 1. You can also set the minimum time during which the MOVE output turns ON, using the application parameter for minimum ON time for MOVE signal.
- *4 If the MBC output is to be used, select the output in the application parameter for output signal selection 1.
- *5 Since the operating speed cannot be set in the tension control mode, the motor may operate at high speed at the end of winding if the load is too small. For your reference, the speed limit value can be set in operation data. Once the specified speed limit is reached, the VLC output will turn ON.

memo When a system parameter has been changed, the new setting will become effective after the power is turned on again. If a 24 VDC power supply is used, also turn on the 24 VDC power supply again.

■ Unwinding operation

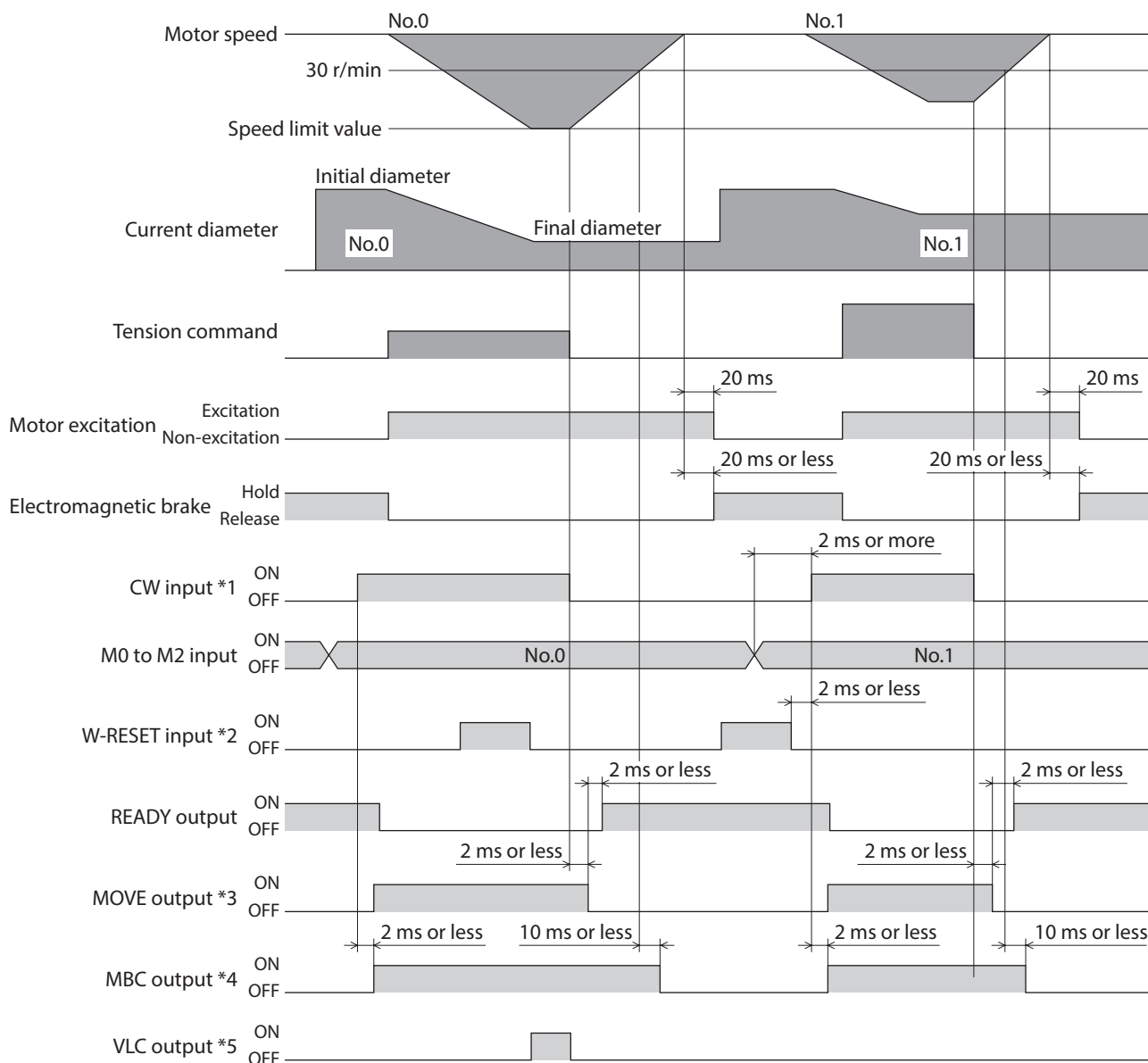

*1 The direction in which the motor rotates when the CW input turns ON can be set in the system parameter for motor rotation direction.

The CCW input is not used in high function mode I or high function mode II. In these modes, set the direction in the motor rotation direction parameter.

*2 Turning the W-RESET input ON during operation will not trigger a reset.

*3 If the MOVE output is to be used, select the output in the application parameter for output signal selection 1. You can also set the minimum time during which the MOVE output turns ON, using the application parameter for minimum ON time for MOVE signal.

*4 If the MBC output is to be used, select the output in the application parameter for output signal selection 1.

*5 Since the operating speed cannot be set in the tension control mode, the motor may operate at high speed at the end of winding if the load is too small. For your reference, the speed limit value can be set in operation data. Once the specified speed limit is reached, the VLC output will turn ON.



When a system parameter has been changed, the new setting will become effective after the power is turned on again. If a 24 VDC power supply is used, also turn on the 24 VDC power supply again.

■ Resetting the roll diameter: W-RESET input

In high function mode I and high function mode II, the current winding (unwinding) diameter is calculated. If the W-RESET is turned ON while the motor is stopped, the winding (unwinding) diameter will be reset to the initial diameter at the ON edge of the W-RESET input. Nothing will happen if the W-RESET input is turned ON while the motor is operating.

■ Notifying that the motor is ready: READY output

When the motor becomes ready, the READY output will turn ON. Confirm that the READY output is ON before inputting pulses. The READY output remains ON while pulses are input. The READY output is OFF under the following conditions. Motor operation is disabled while the READY output is OFF:

- The main power supply is cut off.
- An alarm is present.
- The FREE input, CW input or CCW input is ON.
- A remote operation is performed using **MEXE02**.
- An operation is performed on the **OPX-2A** in the test mode or copy mode.

■ Notifying that operation is in progress: MOVE output

The MOVE output can be enabled by selecting the output using the application parameter for output signal selection 1. The MOVE output remains ON while the motor is operating. You can set the minimum time during which the MOVE output remains ON using the application parameter for minimum ON time for MOVE signal. Even in a short operation, the MOVE output will remain ON for the time set in this parameter.

Example: When 10 ms is set in the parameter for minimum ON time for MOVE signal

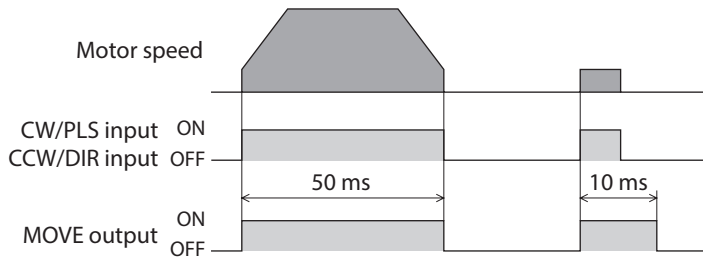

■ Notifying the timing of electromagnetic brake control: MBC output

Use the MBC output to control the electromagnetic brake using a programmable controller, etc. The MBC output can be enabled by selecting the output using the application parameter for output signal selection 1. The MBC output will turn ON when the electromagnetic brake is released, and turn OFF when the electromagnetic brake is actuated (= to hold the load in position). Set the programmable controller to control the electromagnetic brake by detecting the ON/OFF status of the MBC output.

■ Notifying that the speed is being limited: VLC output

When the detected speed reaches the speed limit, the VLC output will turn ON.

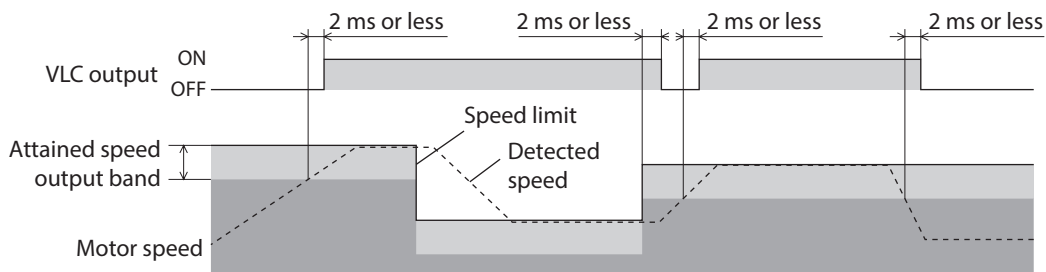

■ Notifying that the detected speed has become zero: ZV output

The ZV output can be enabled by selecting the output using the application parameter for output signal selection 2. When the detected speed drops into the zero speed output band, the ZV output will turn ON. You can set the band within which the ZV output turns ON, using the application parameter for zero speed output band.

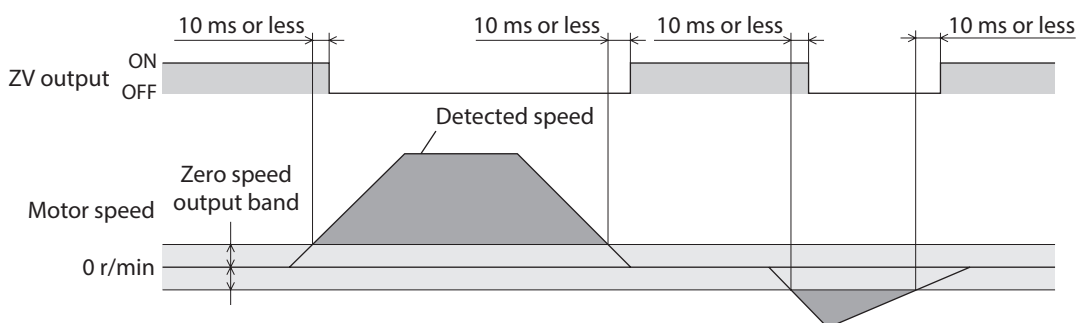

■ Freeing the motor output shaft: FREE input

When the FREE input is turned ON, the motor current will be cut off. The motor will lose its holding torque, and the output shaft can be turned with an external force. The deviation counter will also be cleared. If the FREE input is turned ON while the position is held with the electromagnetic brake, the electromagnetic brake will be released. Accordingly, the position can no longer be held.

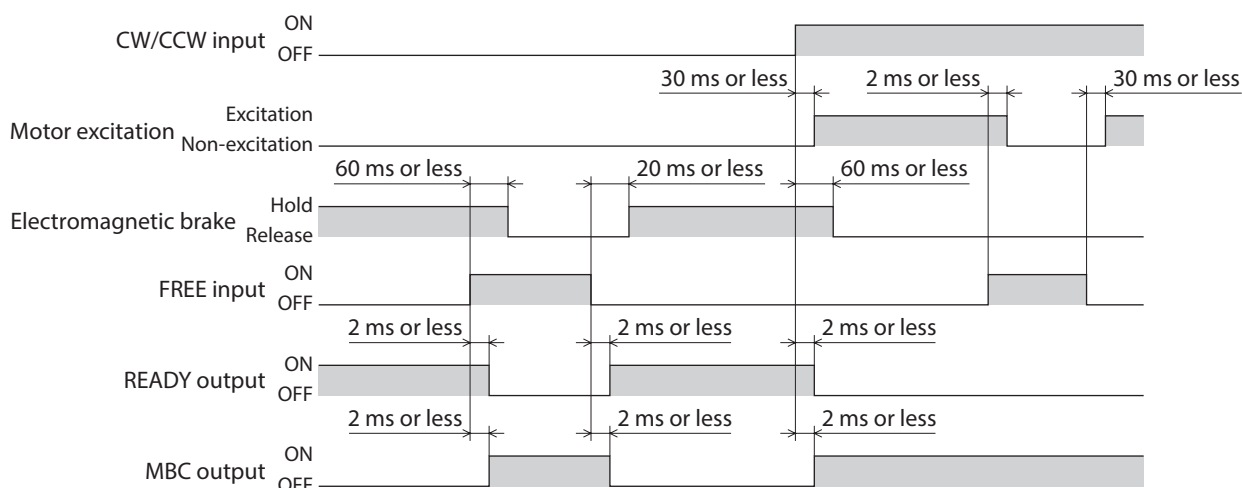

7 Speed limit

Since speed control is not performed during tension controlled operation, the motor may operate at high speed if the load is too small. To prevent this from happening, you can limit the speed of the motor operating under tension control.

Set a speed limit value under each of eight operation data numbers from 0 to 7.

When the system parameter for analog input signals is set to "1: Enable," two analog points and six digital points are available to assign settings. If the parameter is set to "0: Disable," eight digital points are available to assign settings.

Operation data	Analog input signals	
	Enable (initial value)	Disable
No.0	Analog setting (internal potentiometer VR2)	Digital setting
No.1	Analog setting (External potentiometer or external DC voltage)	Digital setting
No.2 to No.7	Digital setting	



One set of the speed limit, the tension command, the material thickness, the initial diameter, the final diameter, the taper setting, the material inertial moment, and the core inertial moment can be set in the operation data No.0 to No.7 each. Use by switching an operation data according to the operating condition. Select an operation data based on a combination of the ON/OFF status of the M0 to M2 inputs.

* Simple mode: Tension command value (p.141)

High function mode I: Tension command value (p.146), initial diameter, material thickness, final diameter (p.149), taper (p.150)

High function mode II: Tension command value (p.146), initial diameter, material thickness, final diameter (p.149), material inertial moment, core inertial moment (p.149), taper (p.150)

● Initial value

Operation data	Speed limit [r/min]	Tension command [%]	Material thickness [μm]	Initial diameter [mm]	Final diameter [mm]	Taper setting [%]	Material inertial moment [$\times 10^{-4}$ kgm ²]	Core inertial moment [$\times 10^{-4}$ kgm ²]
No.0 to No.7	0	0	50	500	1,000	100	0	0

● Data selection method

Operation data	M2 input	M1 input	M0 input
No.0	OFF	OFF	OFF
No.1	OFF	OFF	ON
No.2	OFF	ON	OFF
No.3	OFF	ON	ON
No.4	ON	OFF	OFF
No.5	ON	OFF	ON
No.6	ON	ON	OFF
No.7	ON	ON	ON

7-1 Using the internal potentiometer VR2

1. Set the system parameter for analog input signals to "1: Enable."

memo When a system parameter has been changed, the new setting will become effective after the power is turned on again. If a 24 VDC power supply is used, also turn on the 24 VDC power supply again.

2. Turn the M0 to M2 inputs OFF and select operation data No.0.
3. Set the speed limit value using the internal potentiometer VR2.
Setting range: 0 to 5,500 r/min
Factory setting: 0 r/min

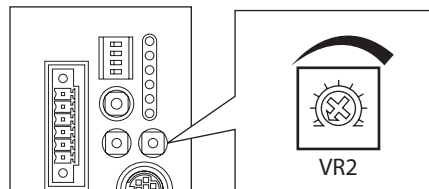

7-2 Using an external potentiometer or external DC voltage

1. Set the system parameter for analog input signals to "1: Enable."

memo When a system parameter has been changed, the new setting will become effective after the power is turned on again. If a 24 VDC power supply is used, also turn on the 24 VDC power supply again.

2. Turn the M0 input ON and M1 and M2 inputs OFF, and select operation data No.1.
3. Connect an external potentiometer or external DC voltage to pin No.1 to No.3 of the analog I/O connector (CN6). Refer to p.56 for details on the connection method.
4. Set the gain.
Set the speed command value per 1 V of voltage command in the application parameter for analog speed limit gain.
Setting range: 0 to 5,500 r/min
Initial value: 550 r/min
5. Set the offset.
If there is even a slight margin of error in the voltage value, the speed limit value may not become 0 r/min even when the voltage command specifies 0 V (minimum value). In this case, adjust the offset using one of the two methods described below.

Automatic adjustment

- 1) Set the application parameter for analog input signal automatic offset to "1: Enable."
- 2) Input 0 V to the analog speed input terminal (pin No.1 of CN6).
- 3) Apply the offset for analog speed input using the **MEXE02** or the **OPX-2A**.

Adjustment using a parameter

- 1) Set the application parameter for analog input signal automatic offset to "0: Disable."
- 2) Set the offset voltage in the application parameter for analog speed limit offset voltage.

6. Set the speed limit value using an external potentiometer or external DC voltage.

Setting example

Setting example	Analog speed limit gain	Analog speed limit offset voltage	Description
①	550 r/min	0 V	The speed limit value per 1 V of voltage command becomes 550 r/min.
②	10 r/min	0 V	The speed limit value per 1 V of voltage command becomes 10 r/min.
③	550 r/min	1 V	The home of voltage command becomes 1 V. The gain of speed limit value is the same as in example ①.

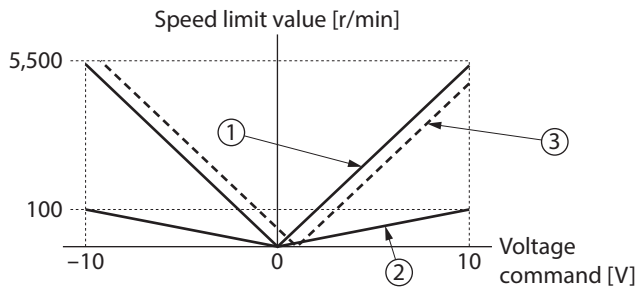

7-3 Digital setting

- When the analog input signals parameter is set to "1: Enable"

1. Set the system parameter for analog input signals to "1: Enable."

memo When a system parameter has been changed, the new setting will become effective after the power is turned on again. If a 24 VDC power supply is used, also turn on the 24 VDC power supply again.

2. Use the **MEXE02** or the **OPX-2A** to set one of operation data No.2 to No.7 as the speed command value.
3. Combine the ON/OFF statuses of M0 to M2 inputs to select one of operation data No.2 to No.7.

- When the analog input signals parameter is set to "0: Disable"

1. Set the system parameter for analog input signals to "0: Disable."

memo When a system parameter has been changed, the new setting will become effective after the power is turned on again. If a 24 VDC power supply is used, also turn on the 24 VDC power supply again.

2. Use the **MEXE02** or the **OPX-2A** to set one of operation data No.0 to No.7 as the speed command value.
3. Combine the ON/OFF statuses of M0 to M2 inputs to select one of operation data No.0 to No.7.

7 Operation using the OPX-2A

This part explains the overview and operating method for the OPX-2A.

◆Table of contents

1	Overview of the OPX-2A.....	160	7	Data mode	187
1-1	Names and functions of parts.....	161	7-1	Data selection method	187
1-2	How to read the display	161	7-2	Setting item of operation data	187
1-3	OPX-2A error display.....	162	8	Test mode.....	189
2	Screen transitions in the position control mode	163	8-1	Overview of the test mode	189
3	Screen transitions in the speed control mode	168	8-2	I/O test	189
4	Screen transitions in the torque control mode	173	8-3	JOG operation.....	191
5	Screen transitions in the tension control mode	178	8-4	Preset the current position.....	191
6	Monitor mode	184	8-5	Preset the Z-phase.....	191
6-1	Overview of the monitor mode.....	184	8-6	Offset the analog speed input.....	191
6-2	Monitor item.....	184	8-7	Offset the analog torque input.....	192
6-3	Descriptions of I/O monitor	185	9	Copy mode.....	193
			9-1	Overview of the copy mode	193
			9-2	Error of the copy mode.....	194

1 Overview of the OPX-2A

The **OPX-2A** is a data setter that lets you set operating data and parameters, perform monitoring, etc. In addition, the **OPX-2A** can be used to save the driver data. There are four destinations (data banks) to save data. Since the data is saved in the non-volatile memory, it is not erased even if the power is shut down.

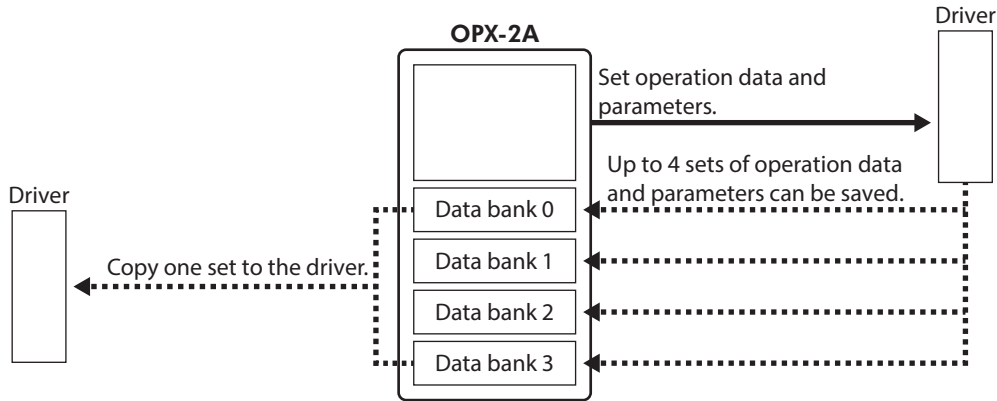

The **OPX-2A** can be used for the following purposes:

- Set operation data or parameters for the driver.
- Monitor the operating condition of the motor.
- Check and clear the alarm and warning records.
- The operation data and parameters set in the driver can be saved to the **OPX-2A**.
- The operation data and parameters saved in the **OPX-2A** can be copied to another driver connected to the **OPX-2A**.

■ Notation

In this manual, keys are denoted by symbols, such as $\left[\begin{smallmatrix} \text{MODE} \\ \text{ESC} \end{smallmatrix} \right]$ [SET] [↑] [↓] [←] [→]. In figures, a simplified illustration of the display and LED indicators is used, as shown below.



■ Edit lock function

Enable the edit lock function if you want to prevent operation data and parameters from being edited or cleared. Operation data and parameters cannot be changed or deleted while the edit lock function is enabled.

● Setting the edit lock function

In the top screen of each operation mode, press the $\left[\begin{smallmatrix} \text{MODE} \\ \text{ESC} \end{smallmatrix} \right]$ key for at least 5 seconds.

The display will show "Lock" and the edit lock function will be enabled.

The "LOCK" LED in the LED indicator area will also be lit.

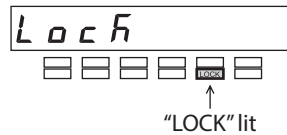

● Canceling the edit lock function

Again in the top screen of each operation mode, press the $\left[\begin{smallmatrix} \text{MODE} \\ \text{ESC} \end{smallmatrix} \right]$ key for at least 5 seconds.

The display will show "UnLock" and the edit lock function will be cancelled.

The "LOCK" LED in the LED indicator area will turn off.



1-1 Names and functions of parts

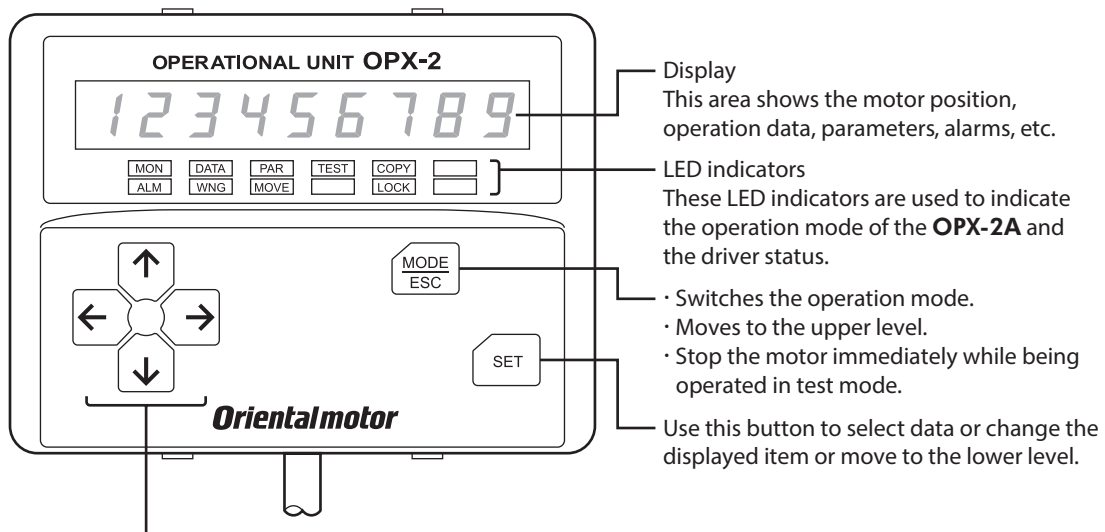

Use these buttons to change the selected item or set data and parameters.

- Use these buttons to increase or decrease the value or change the selected item.
- Use these buttons to navigate through each data or parameter to a desired digit.

1-2 How to read the display

The display consists of 7-segment LEDs. (The number "5" and alphabet "S" are the same.)

• Numbers

1	1	2	2	3	3	4	4	5	5	6	6	7	7	8	8	9	9	0	0
---	---	---	---	---	---	---	---	---	---	---	---	---	---	---	---	---	---	---	---

• Alphabets

A	A	B	b	C	c	D	d	E	E	F	F	G	G	H	H	I	,	J	J	K	K	L	L
M	n̄	N	n	O	o	P	P	Q	q	R	r	S	S	T	t	U	U	V	v	W	w	Y	Y

• Signs

+	+	-	-
---	---	---	---

■ How to read the LED indicators

When the operation mode is changed or an alarm or warning generates, a corresponding LED will be lit. While the edit lock function is enabled, the condition is also indicated by the illumination of a corresponding LED.

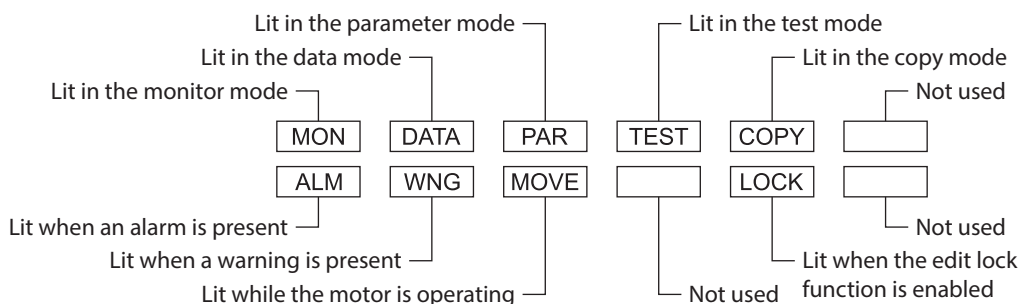

7 Operation using the OPX-2A

1-3 OPX-2A error display

Errors displayed on the **OPX-2A** are explained.

Error display	Description	Remedial action
	A communication error occurred between the OPX-2A and driver.	<ul style="list-style-type: none"> • Check if the OPX-2A is connected securely. • Check if the OPX-2A cable is disconnected or damaged. • The OPX-2A or the communication part of the driver may have damaged. Contact your nearest Oriental Motor sales office.

2 Screen transitions in the position control mode



- The following limitations are present while the edit lock function is enabled.
 - Data mode, parameter mode, copy mode: Although they are displayed on the screen, they are unable to operate.
 - Clearing the alarm and warning records, current position preset, Z-phase preset, analog speed input offset, analog torque input offset: They are not displayed on the screen.
- In the lower level except the top screen, press [MODE/ESC] to return to the previous level.

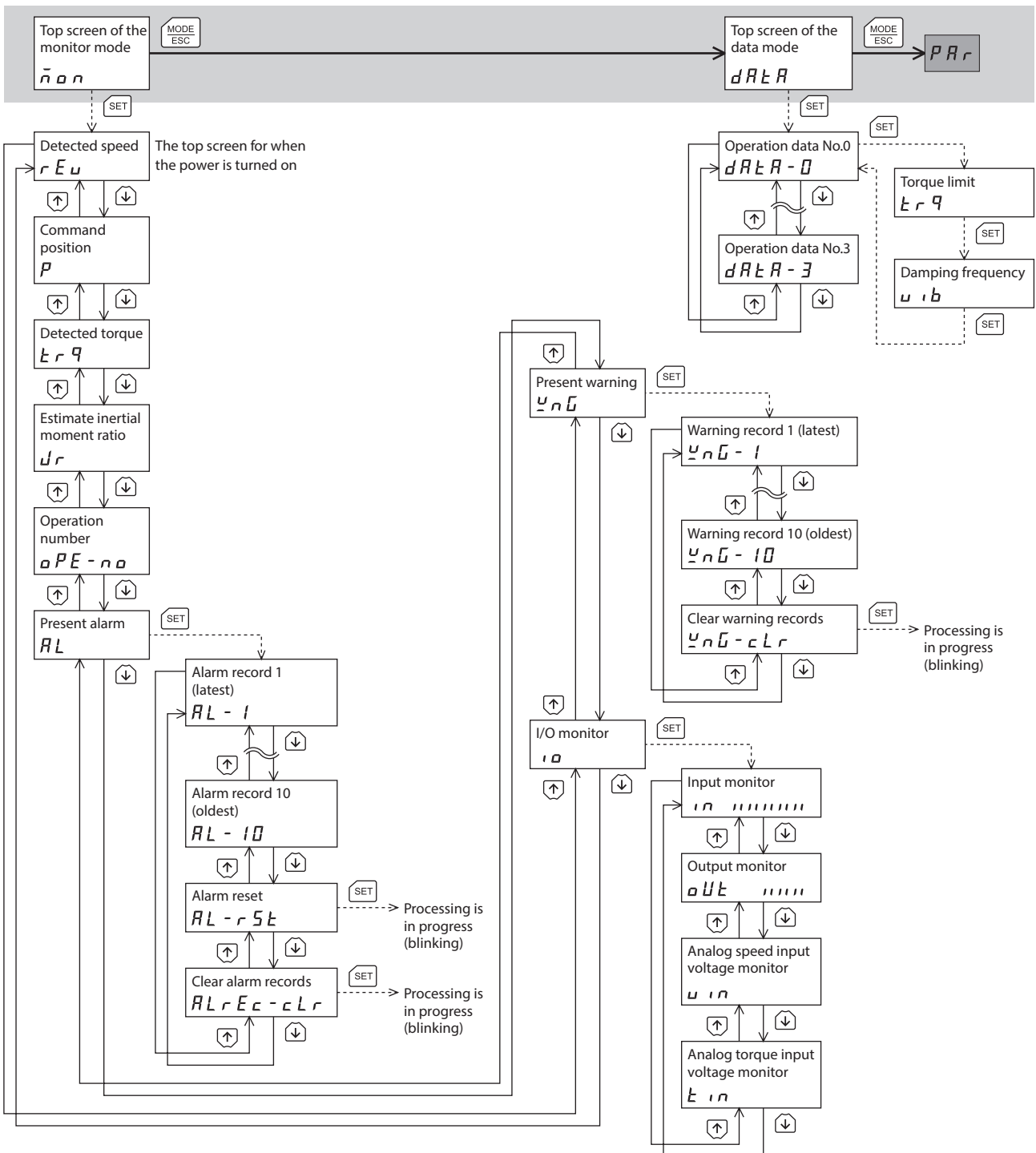

7 Operation using the OPX-2A

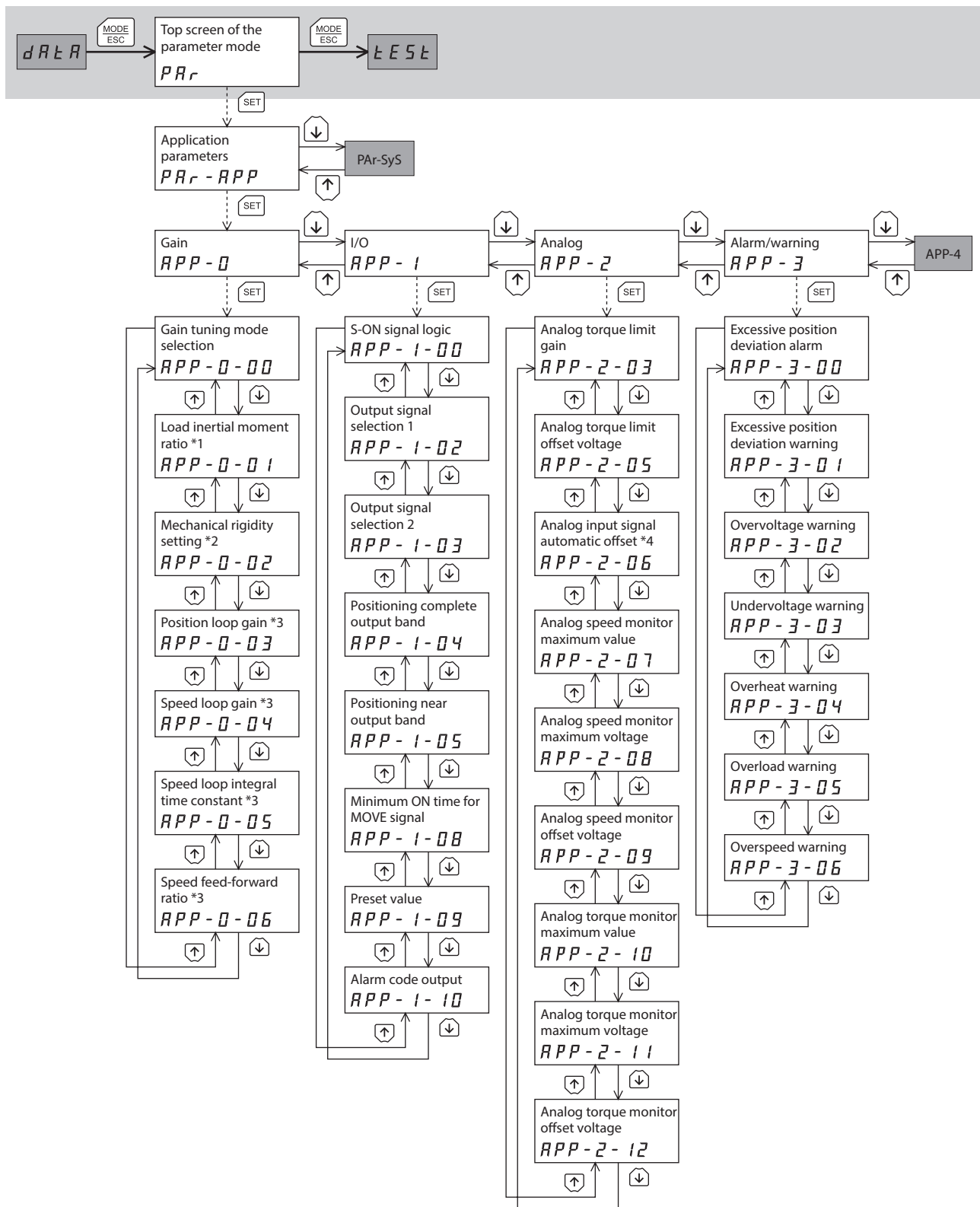

- *1 This parameter is displayed in the semi-auto and manual tuning mode.
- *2 This parameter is used when the "Mechanical rigidity setting switch" parameter is set to "0: Disable." If this parameter is set to "1: Enable," the mechanical rigidity setting switch (SW2) on the driver is used to set the mechanical rigidity.
- *3 This parameter is displayed in the manual tuning mode.
- *4 When the "Analog input signal automatic offset" parameter is set to "1: Enable," the analog speed input offset or analog torque input offset is enabled in the test mode.

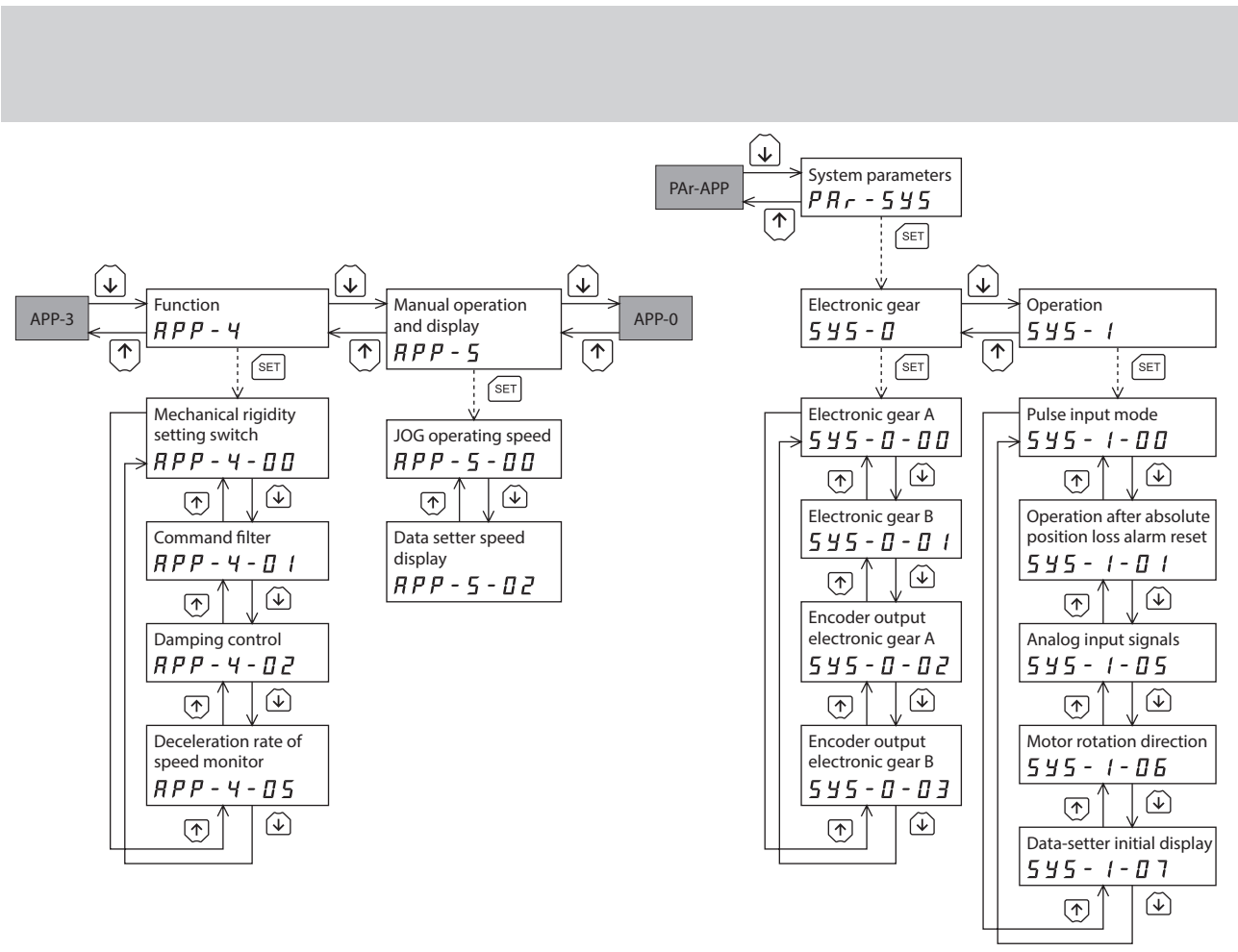

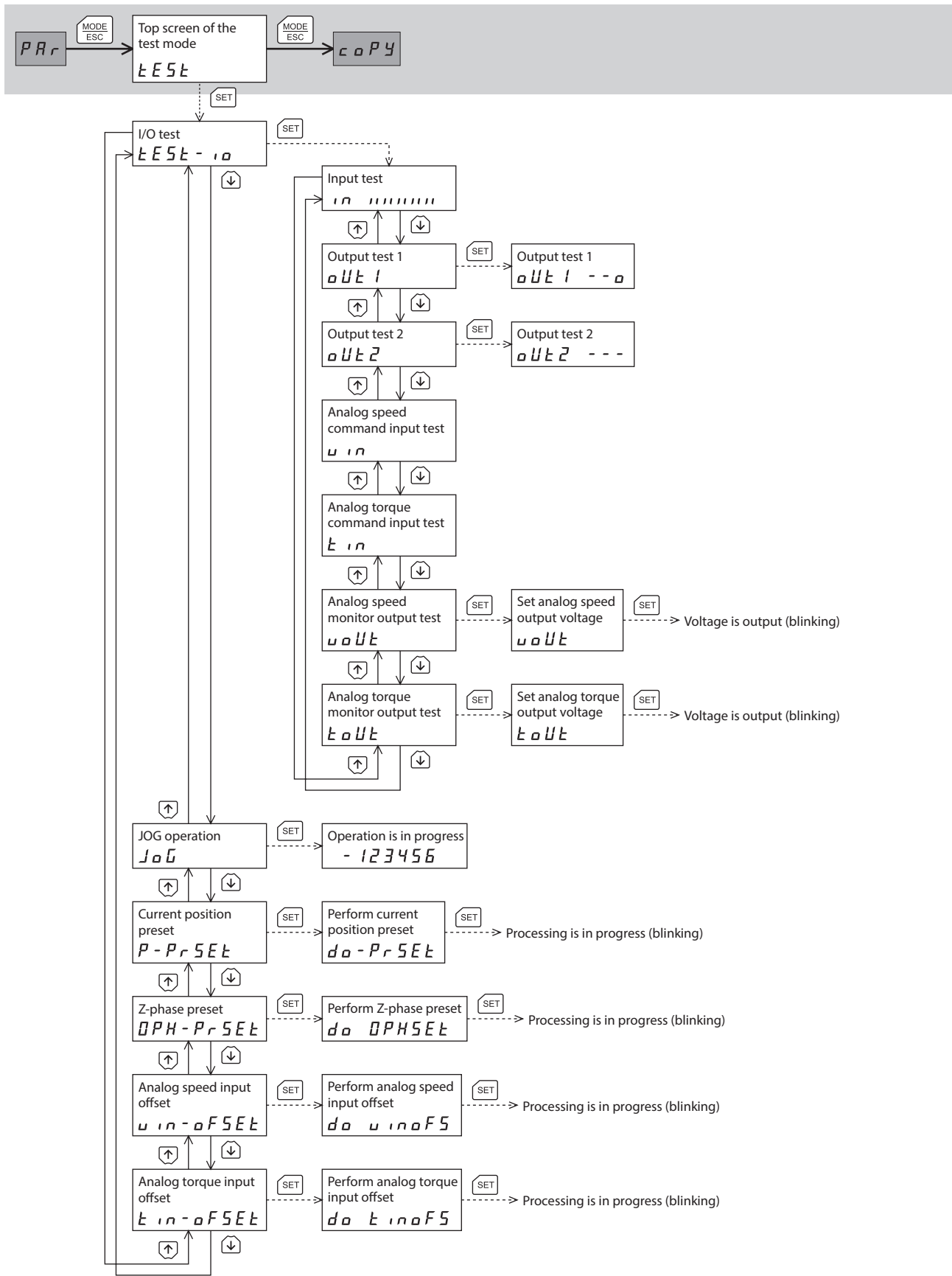

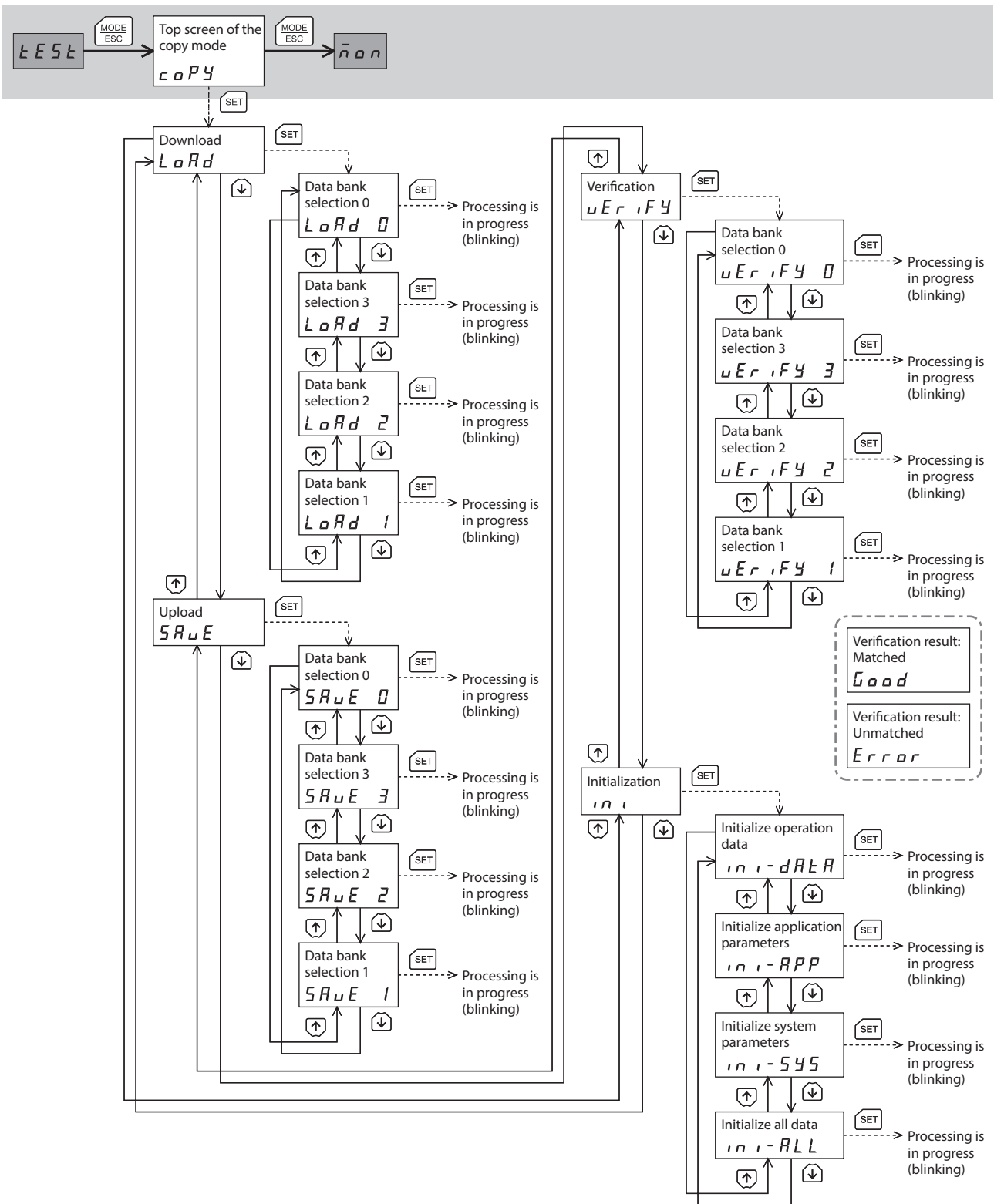

7 Operation using the OPX-2A

3 Screen transitions in the speed control mode



- The following limitations are present while the edit lock function is enabled.
 - Data mode, parameter mode, copy mode: Although they are displayed on the screen, they are unable to operate.
 - Clearing the alarm and warning records, Z-phase preset, analog speed input offset, analog torque input offset: They are not displayed on the screen.
- In the lower level except the top screen, press [MODE/ESC] to return to the previous level.

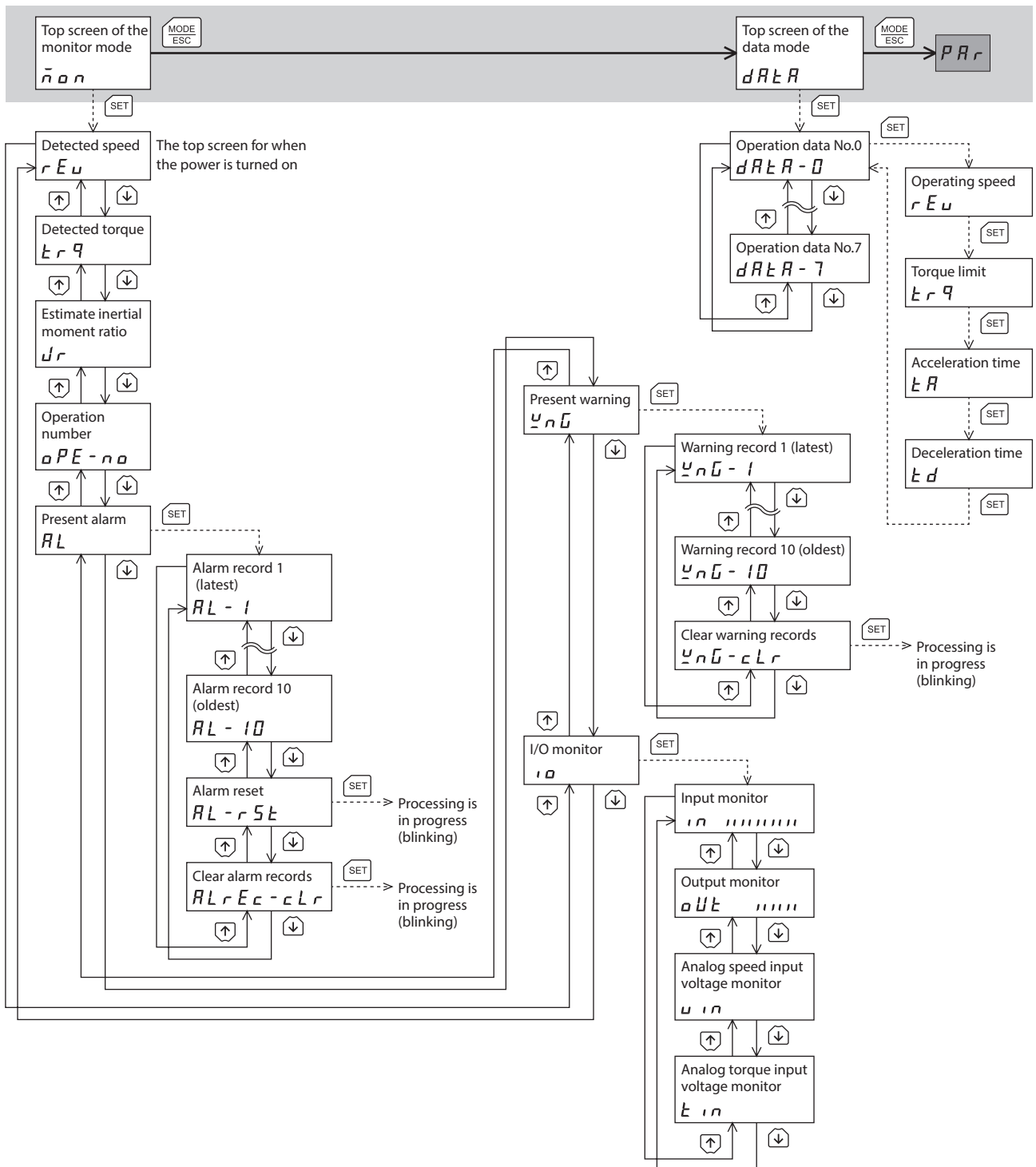

7 Operation using the OPX-2A

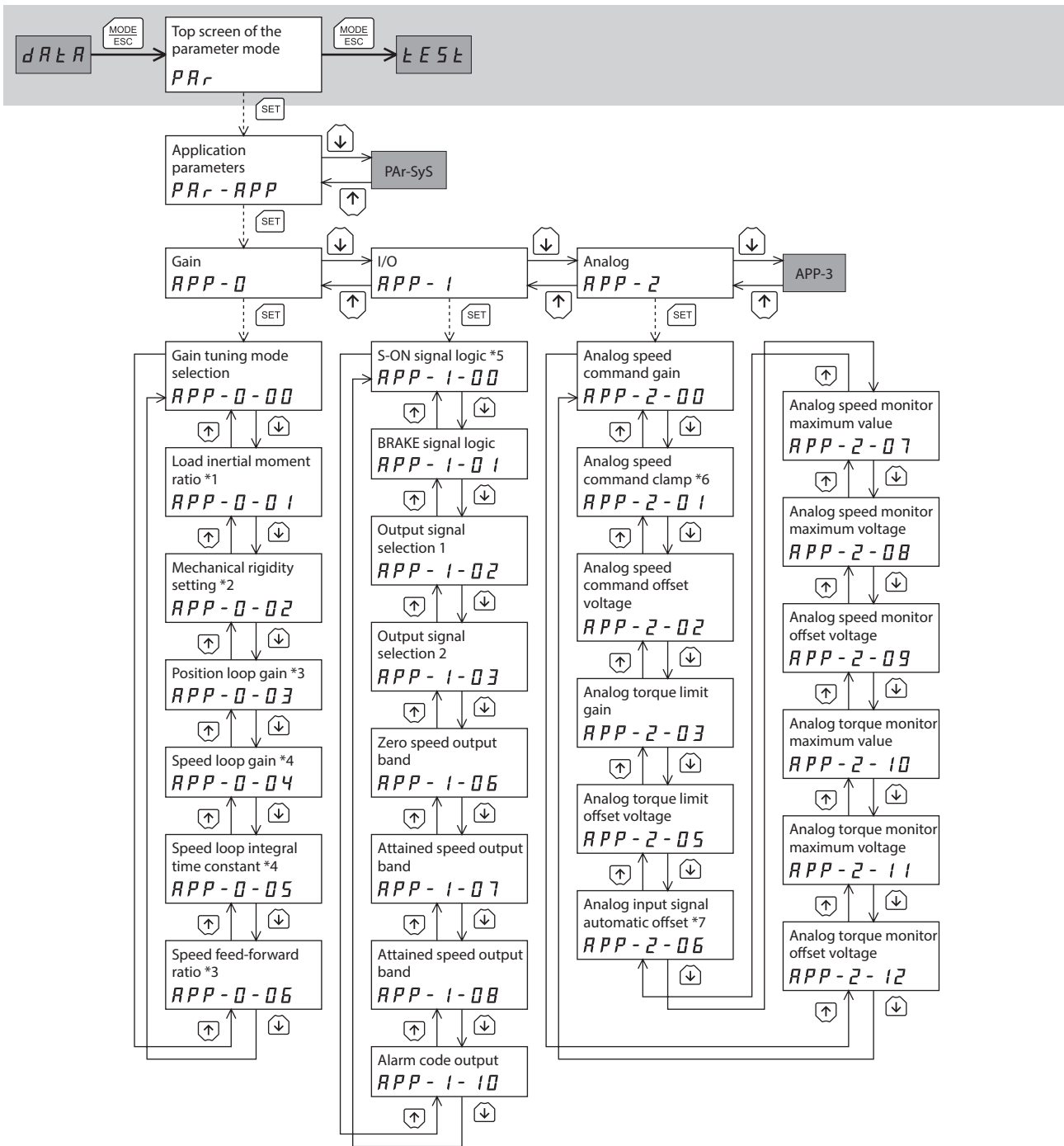

- *1 This parameter is displayed in the semi-auto and manual tuning mode.
- *2 This parameter is used when the "Mechanical rigidity setting switch" parameter is set to "0: Disable." If this parameter is set to "1: Enable," the mechanical rigidity setting switch (SW2) on the driver is used to set the mechanical rigidity.
- *3 This parameter is displayed when the "Operation selection after stopping in speed control mode" parameter is set to "1: Servo lock" in the manual tuning mode.
- *4 This parameter is displayed in the manual tuning mode.
- *5 This parameter is displayed when the "Operation selection after stopping in speed control mode" parameter is set to "1: Servo lock."
- *6 This parameter is displayed when the "Operation selection after stopping in speed control mode" parameter is set to "0: Free."
- *7 When the "Analog input signal automatic offset" parameter is set to "1: Enable," the analog speed input offset or analog torque input offset is enabled in the test mode.

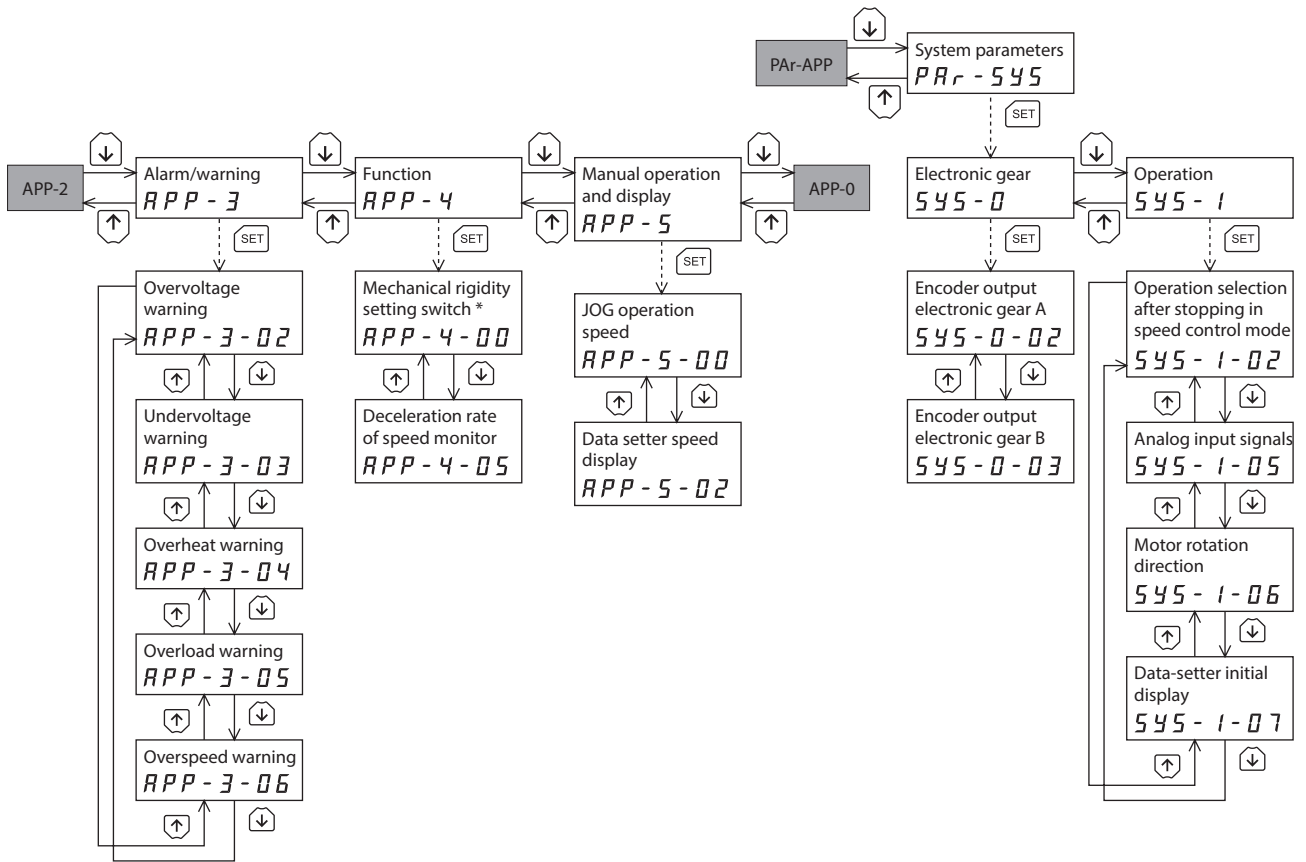

* When the "Mechanical rigidity setting" parameter is set to "0: Disable," the value in the "Mechanical rigidity setting" parameter is enabled.

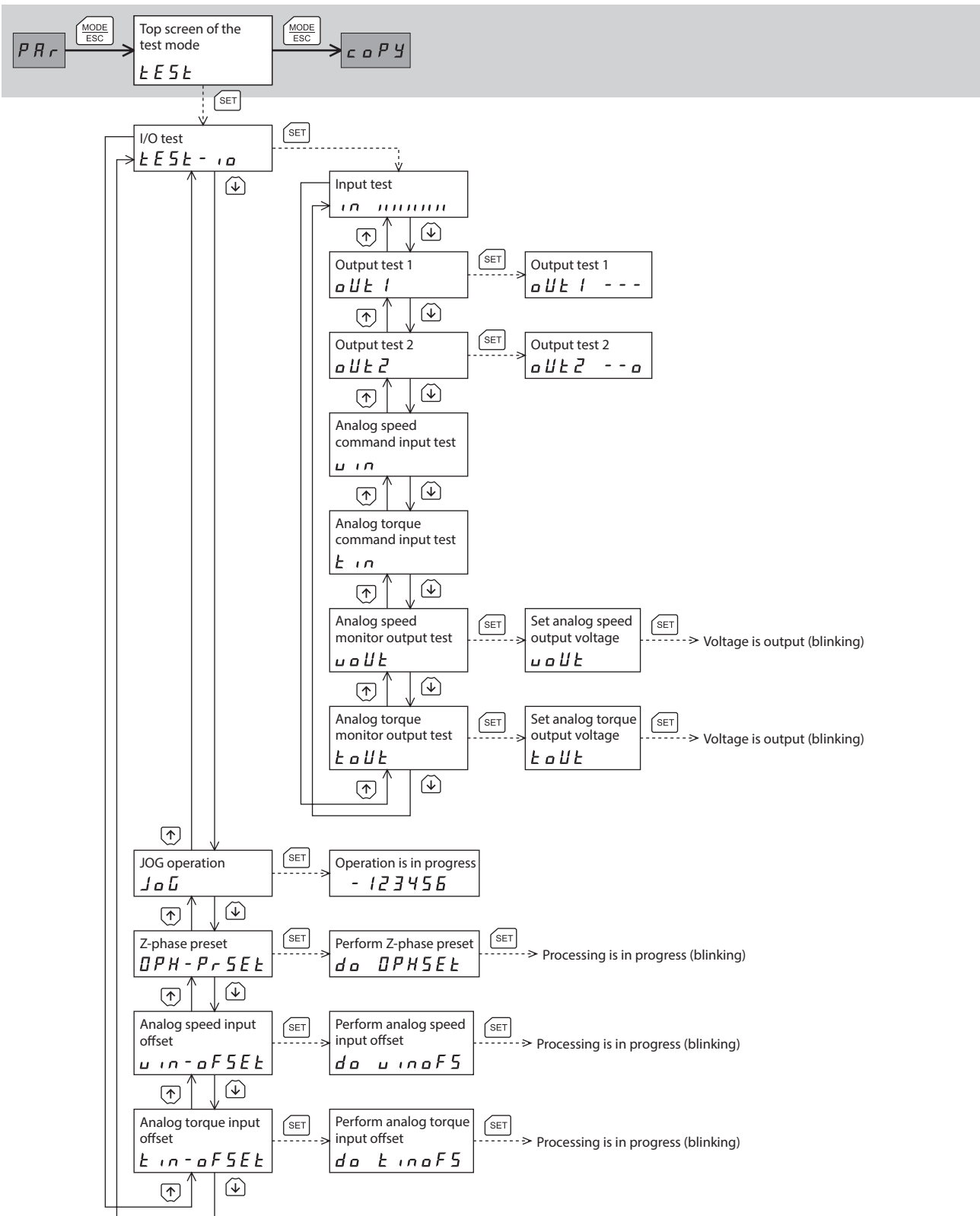

7 Operation using the OPX-2A

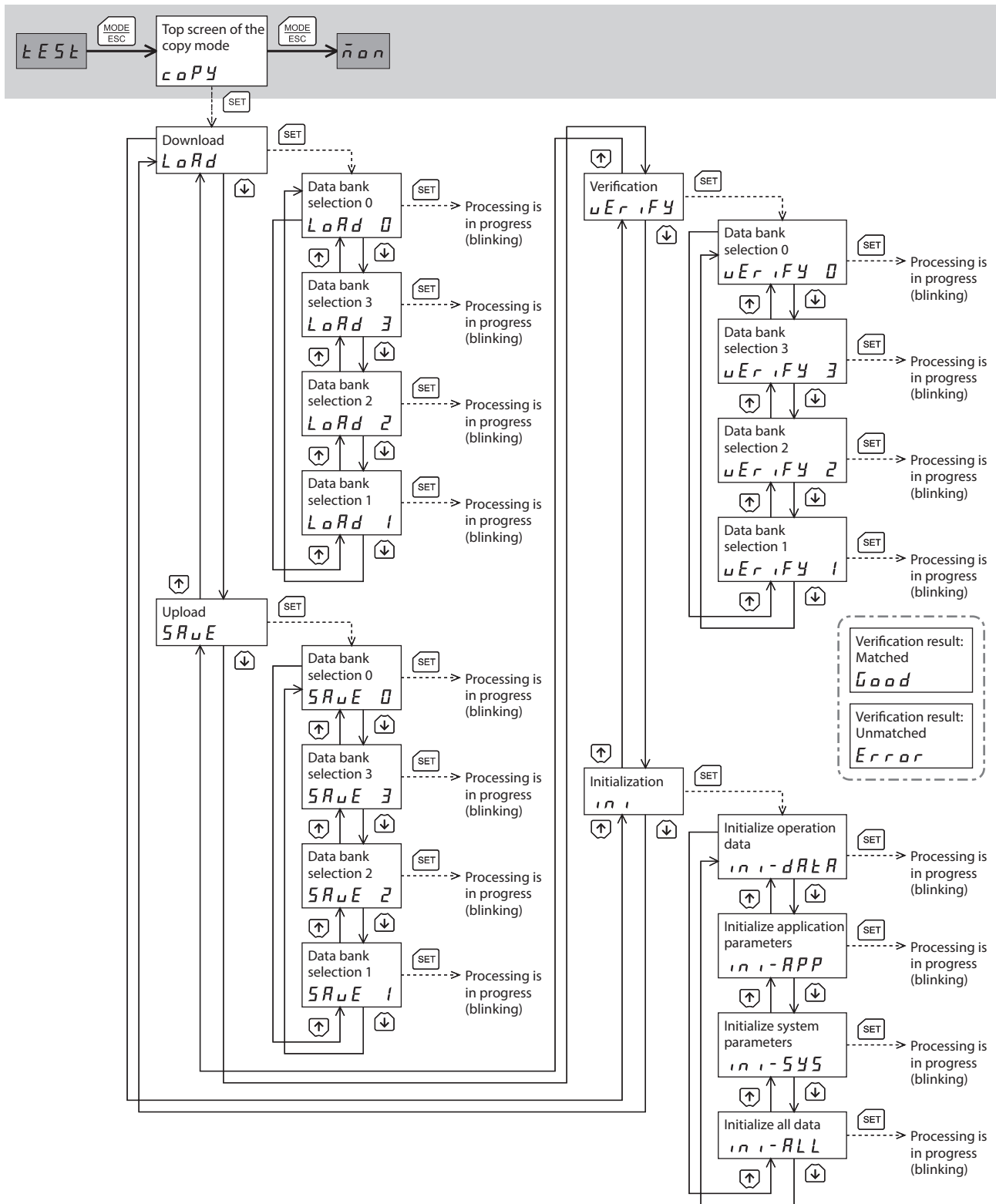

4 Screen transitions in the torque control mode



- The following limitations are present while the edit lock function is enabled.
 - Data mode, parameter mode, copy mode: Although they are displayed on the screen, they are unable to operate.
 - Clearing the alarm and warning records, Z-phase preset, analog speed input offset, analog torque input offset: They are not displayed on the screen.
- In the lower level except the top screen, press [MODE/ESC] to return to the previous level.

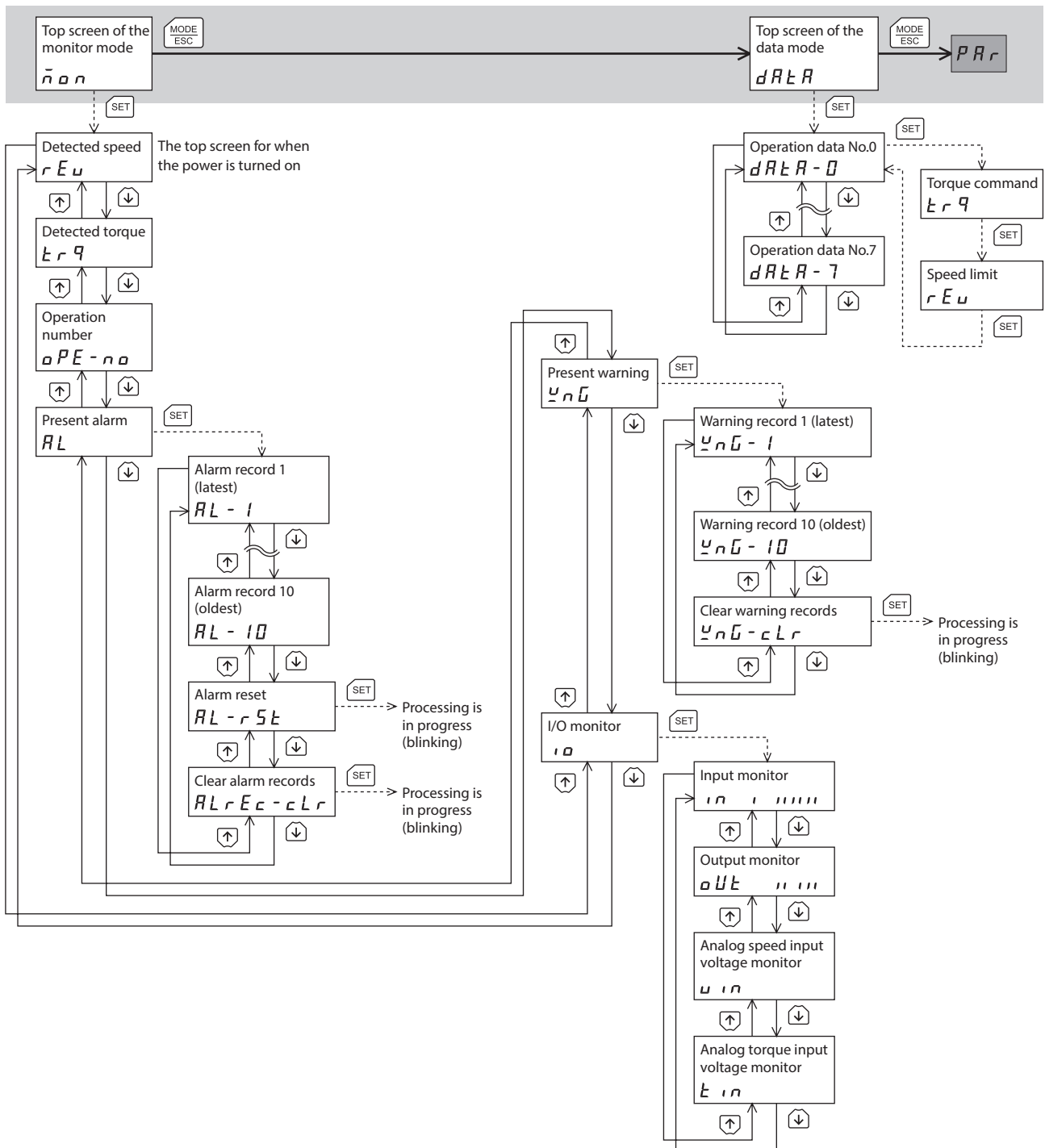

7 Operation using the OPX-2A

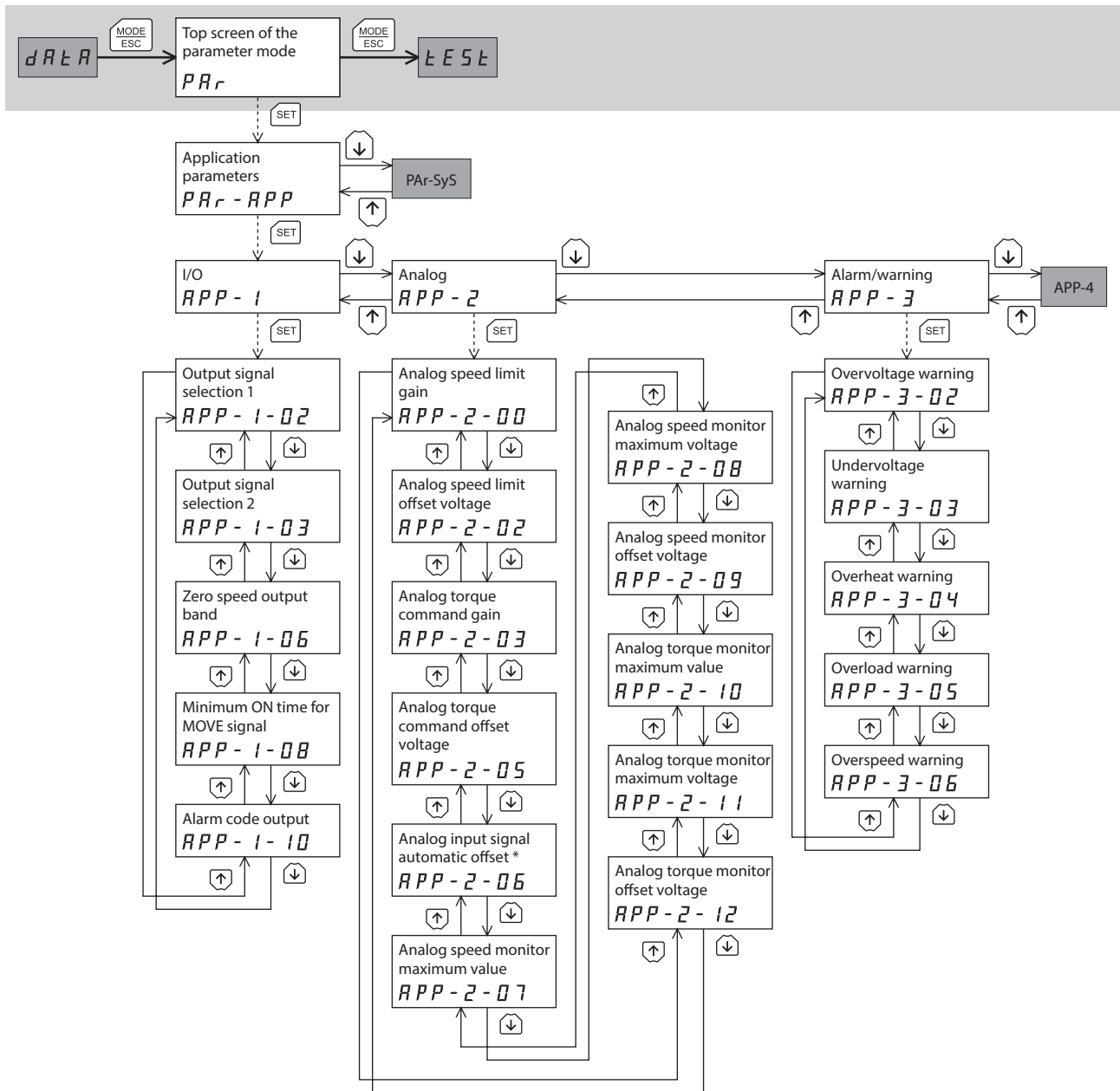

* When the "Analog input signal automatic offset" parameter is set to "1: Enable," the analog speed input offset or analog torque input offset is enabled in the test mode.

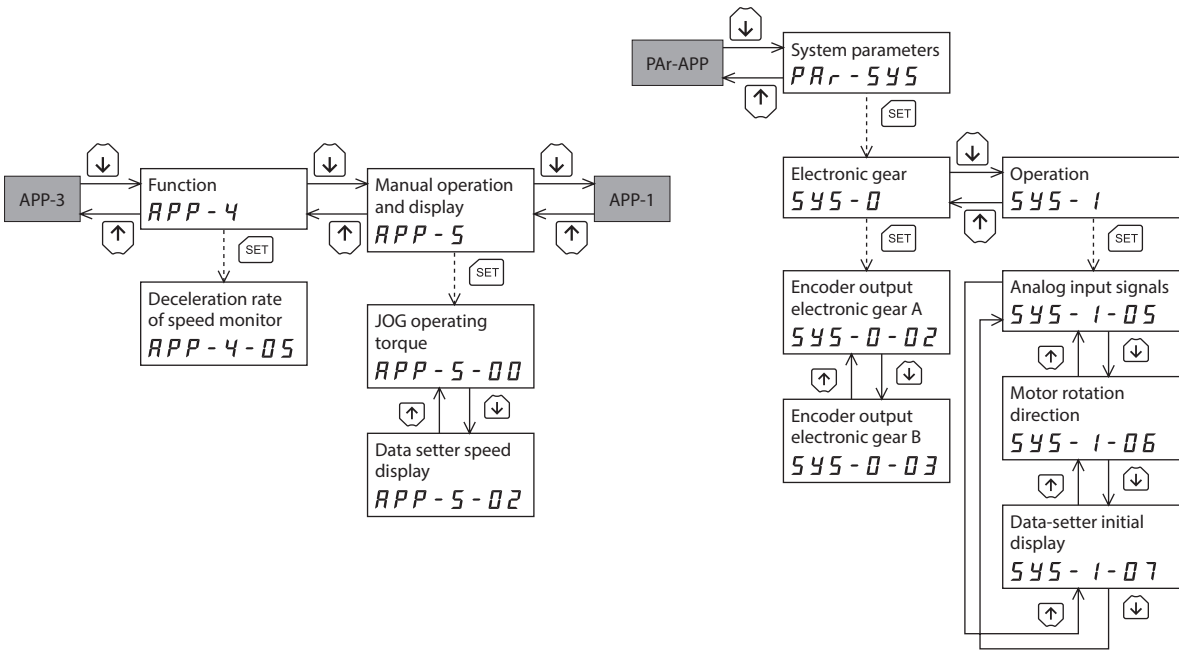

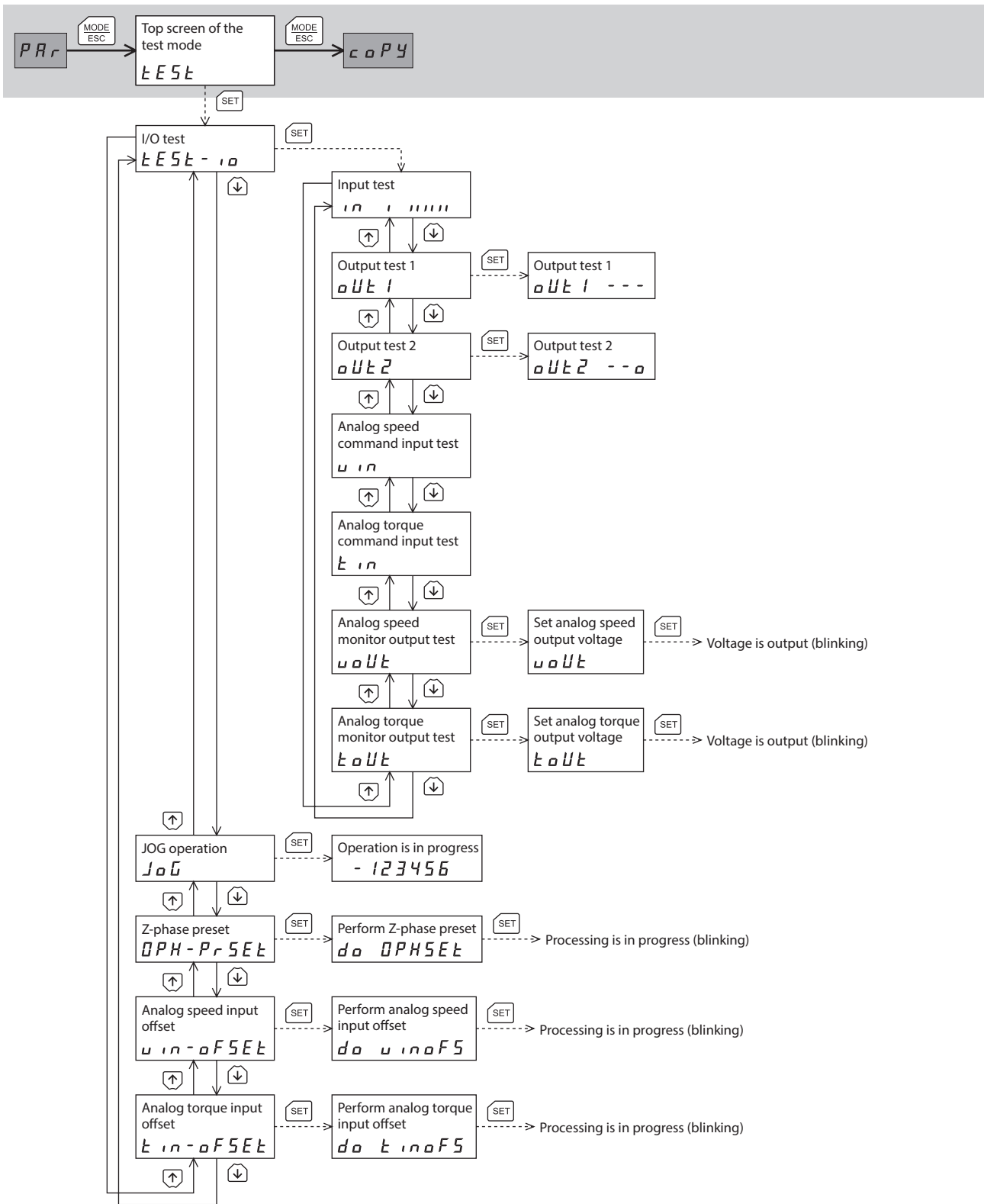

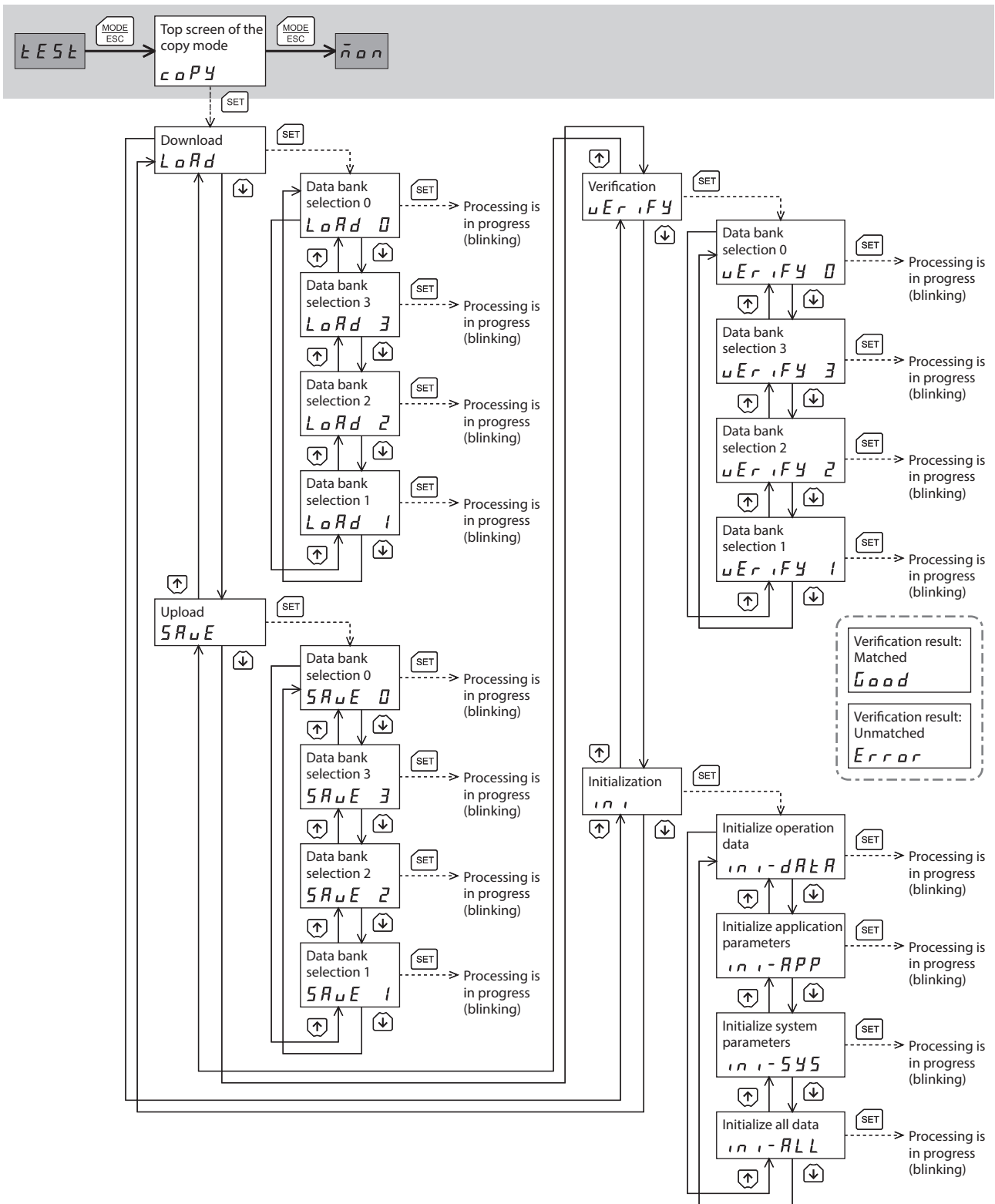

5 Screen transitions in the tension control mode



- The following limitations are present while the edit lock function is enabled.
 - Data mode, parameter mode, copy mode: Although they are displayed on the screen, they are unable to operate.
 - Clearing the alarm and warning records, Z-phase preset, analog speed input offset, analog torque input offset: They are not displayed on the screen.
- In the lower level except the top screen, press [MODE/ESC] to return to the previous level.

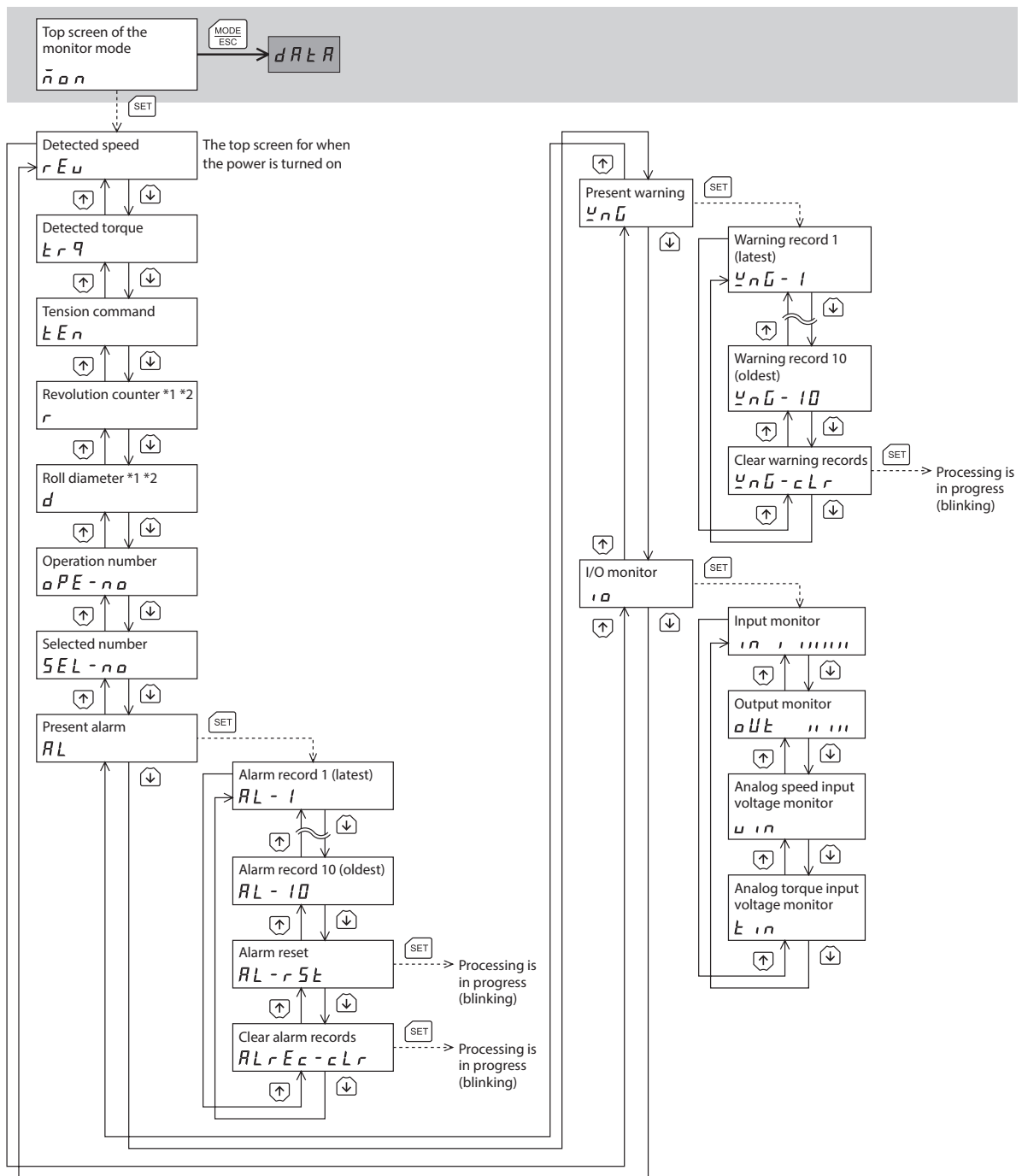

*1 This parameter is displayed in the high function mode I.
 *2 This parameter is displayed in the high function mode II.

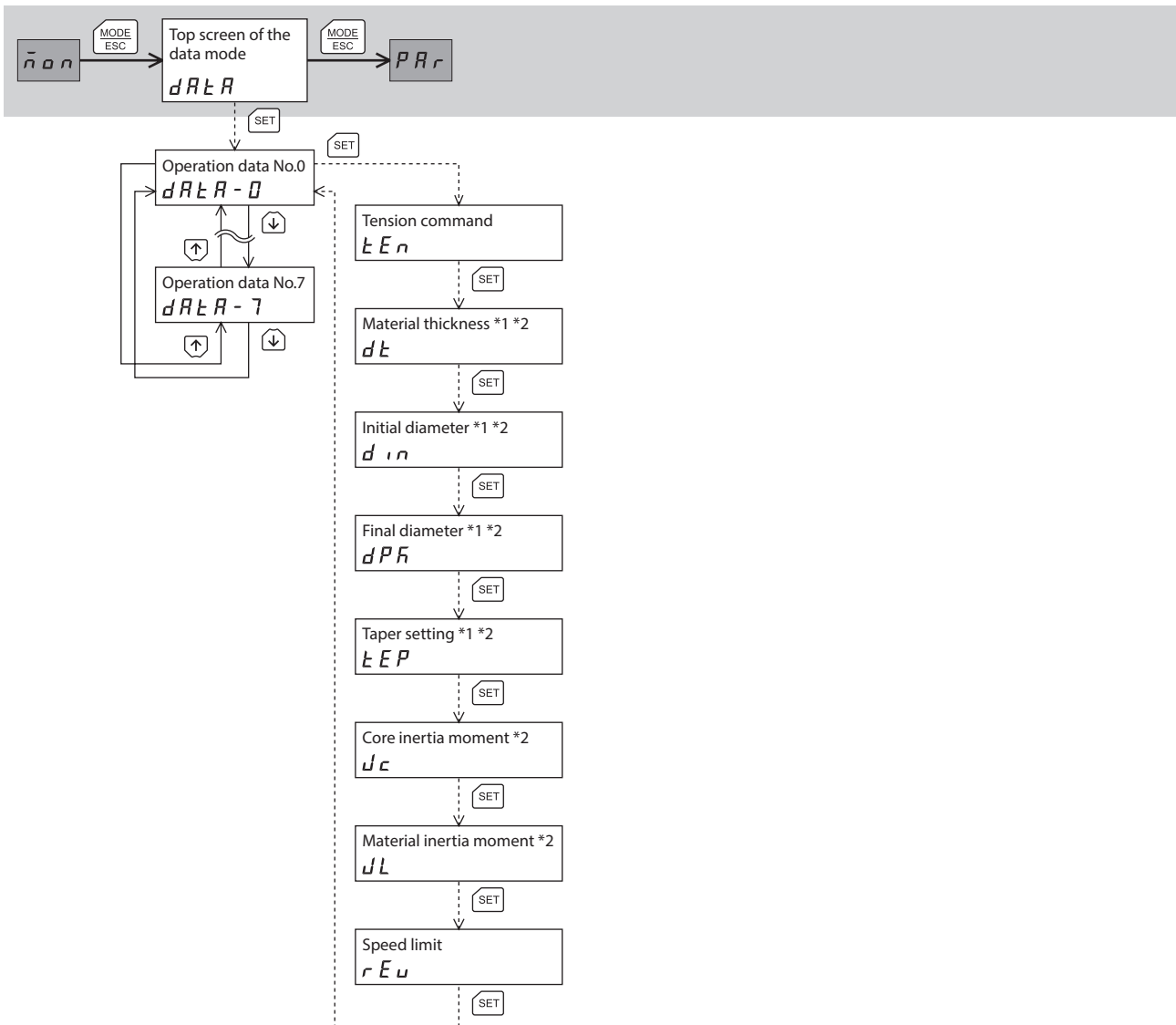

- *1 This parameter is displayed in the high function mode I.
- *2 This parameter is displayed in the high function mode II.

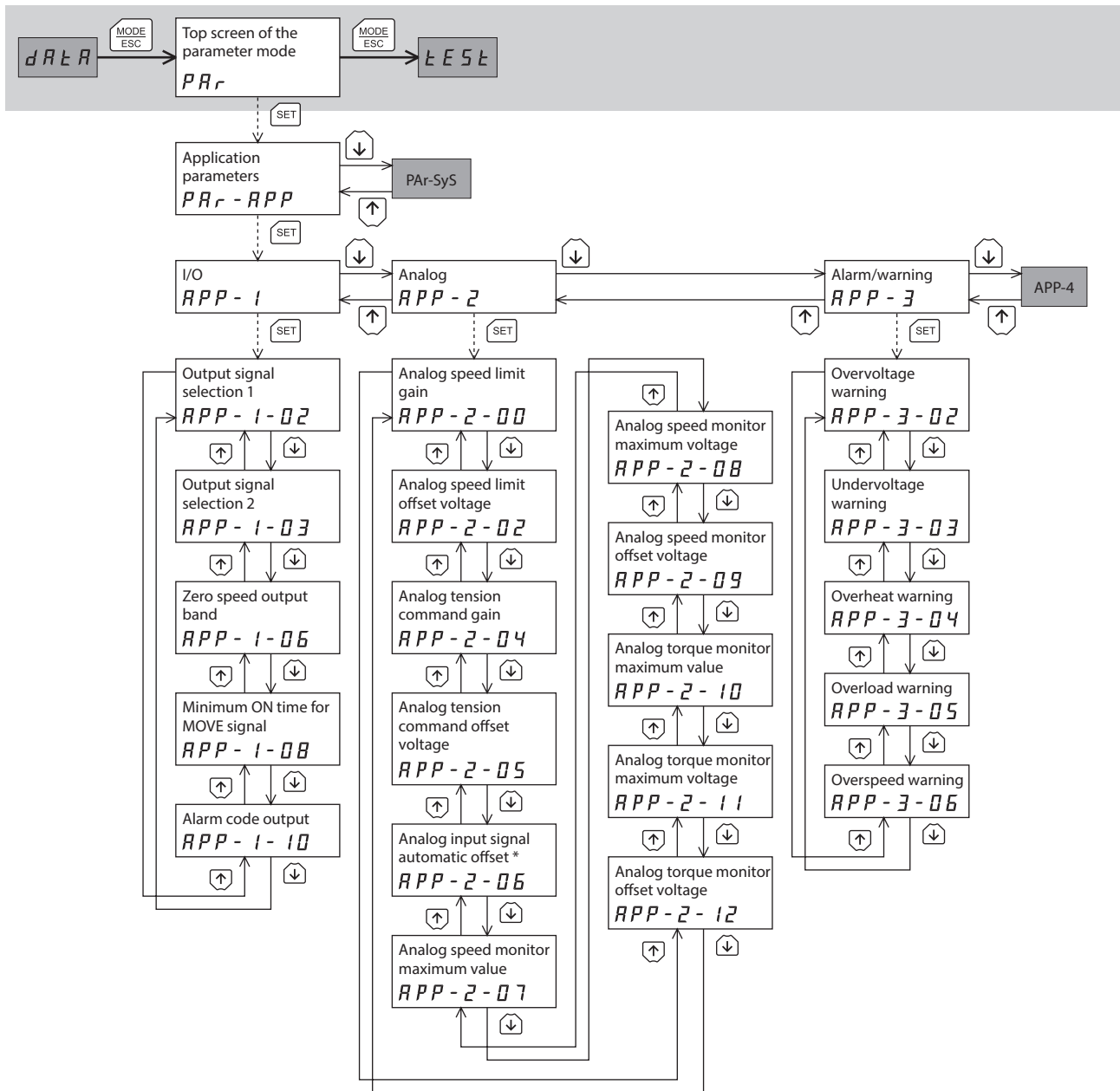

* When the "Analog input signal automatic offset" parameter is set to "1: Enable," the analog speed input offset or analog torque input offset is enabled in the test mode.

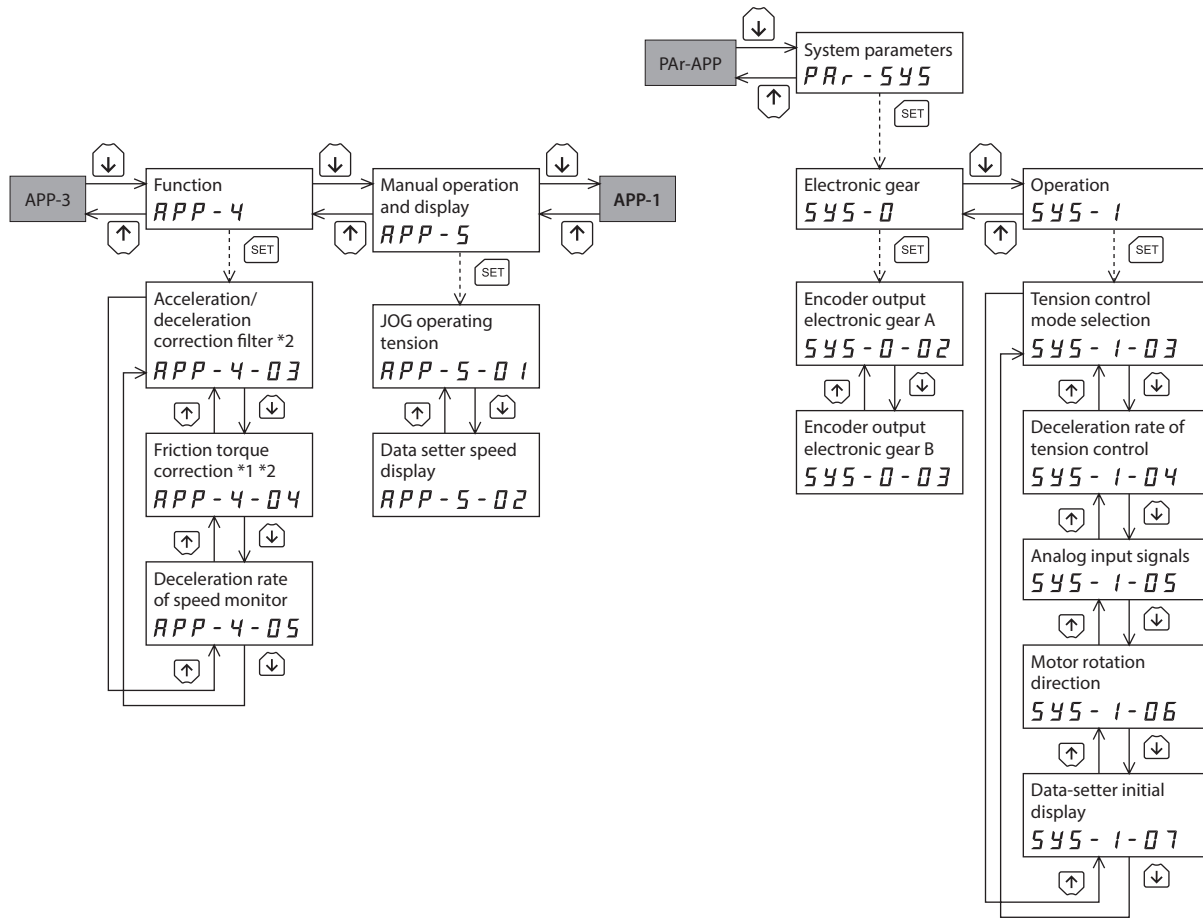

- *1 This parameter is displayed in the high function mode I.
- *2 This parameter is displayed in the high function mode II.

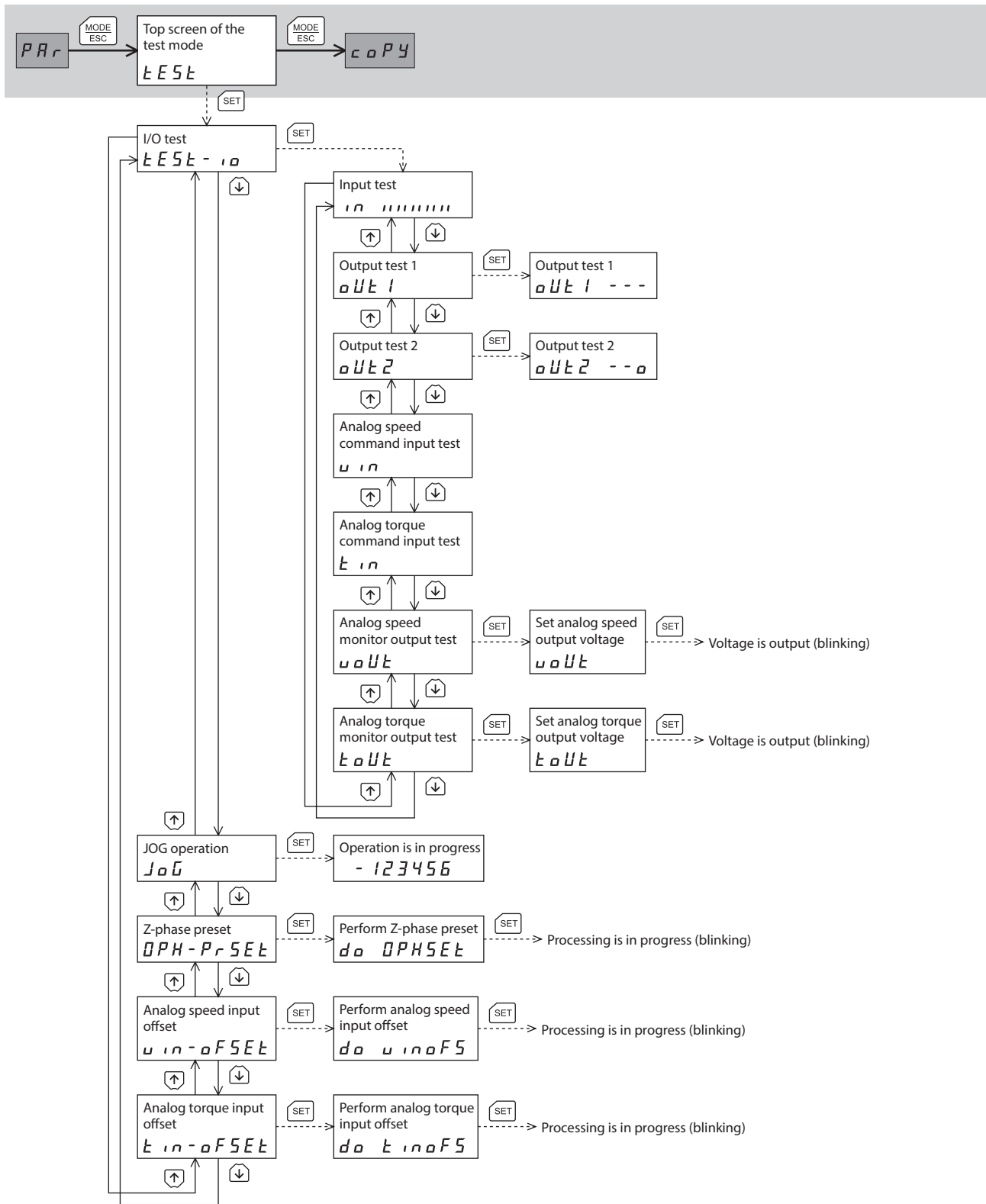

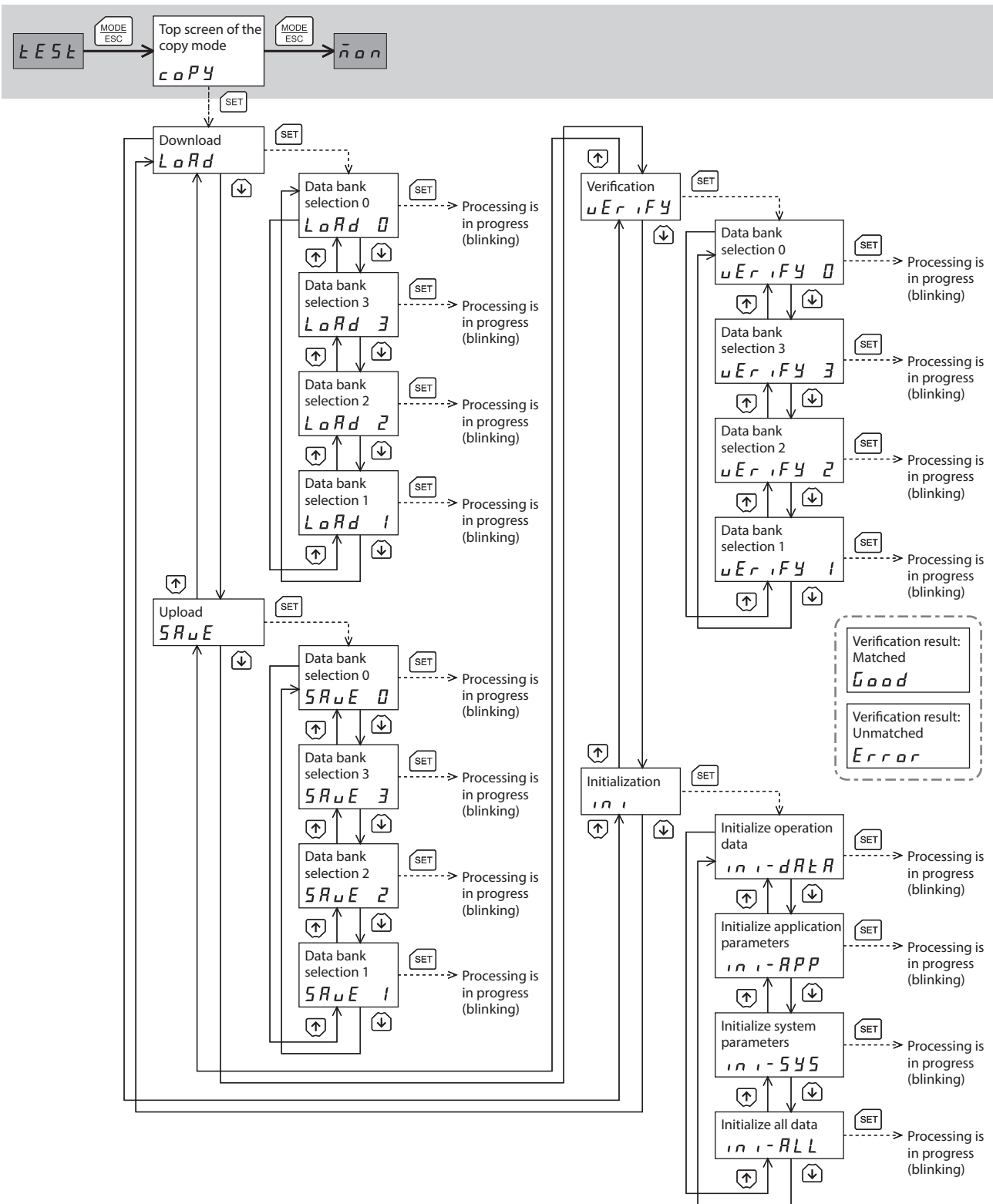

7 Operation using the OPX-2A

6 Monitor mode

6-1 Overview of the monitor mode

● Monitoring the operating status

You can monitor the detected speed, the command position, the detected torque, the estimate inertial moment ratio, the tension command, the revolution counter, the roll diameter, the operation data number presently being operated, and the operation data number selected by the M0 to M2 inputs.

memo A range capable to monitor with the **OPX-2A** is from $-19,999,999$ to $19,999,999$ with up to eight digit numbers. However, only seven digit numbers can be shown on the display of the **OPX-2A**, so only the last seven digit numbers are shown when the monitored value is eight digit numbers, and a dot is marked on the lower right of the display.

● Display example

Actual value	$-19,999,999$	$-10,000,001$	$-10,000,000$	$10,000,000$	$10,000,001$	$19,999,999$
Displayed value	$-9999999.$	$-0000001.$	$-0000000.$	$0000000.$	$0000001.$	$9999999.$

● Checking alarms/warnings, clearing alarm/warning records, and resetting alarms

- If an alarm or warning generates, a corresponding alarm code or warning code will be displayed. You can check the code to identify the details of the alarm/warning.
- Up to ten most recent alarms/warnings can be displayed, starting from the latest one.
- You can reset the alarms currently present.
- You can clear alarm/warning records.

● Checking I/O signals

You can check the ON/OFF status of each I/O signal of the driver, as well as the analog input voltage.

6-2 Monitor item

Item	Description
Detected speed	You can check the speed of the motor (unit: r/min). While the motor is rotating in the CCW direction, "-" is shown in front of the displayed value. If the speed is indicated by an absolute value, no sign is shown to indicate the rotating direction. You can select the value display format using the "Data setter speed display" parameter. You can also display the motor speed as revolutions of the gear output shaft. For this setting, use the "Deceleration rate of speed monitor" parameter.
Detected torque	You can check the generated motor torque. The generated torque is indicated as a percentage of the rated torque being 100 %.
Estimate inertial moment ratio	You can check the load inertial moment ratio estimated internally by the driver. The estimate inertial moment ratio indicates the percentage of the load inertial moment to the rotor inertial moment of the motor. If the rotor inertial moment is the same as the load inertial moment, "100 %" is shown.
Operation number	You can check the operation data number corresponding to the data used in the current operation.
Command position *1	You can check the current position of the motor with reference to the home. If a resolution is set, an appropriate value based on the resolution is shown as steps.
Tension command *2	You can check the tension command value sent to the motor.
Revolution counter *2	You can check the amount of rotation of the winding shaft.
Roll diameter *2	You can check the current roll diameter.
Selected number *2	You can check the operation data number currently selected by the M0 to M2 inputs of the driver.

Item	Description
Present alarm	When an alarm generates, a corresponding alarm code will be displayed. You can also reset alarms or check and clear alarm records. Refer to p.202 for alarm code.
Present warning	When a warning generates, a corresponding warning code will be displayed. You can also check and clear warning records. Refer to p.207 for warning code.
I/O monitor	You can check the ON/OFF status of each I/O signal of the driver. You can also monitor the analog input voltage. For details, refer to the "6-3 Descriptions of I/O monitor"

*1 Position control mode only.

*2 Tension control mode only.

Note Do not turn off the driver power while an alarm is being reset or alarm/warning records are being cleared (=while the display is blinking). Doing so may damage the data.

- memo**
- Some alarms cannot be reset on the **OPX-2A**. To reset these alarms, you must turn on the power again.
 - You can also clear warning records by turning off the driver power.

6-3 Descriptions of I/O monitor

■ Monitor the I/O signals

On the I/O signal monitor screen, each digit on the 7-segment LED display corresponds to a signal. If the signal is ON, the corresponding digit is lit. If the signal is OFF, the digit is unlit.

● Position control mode

• Input signals

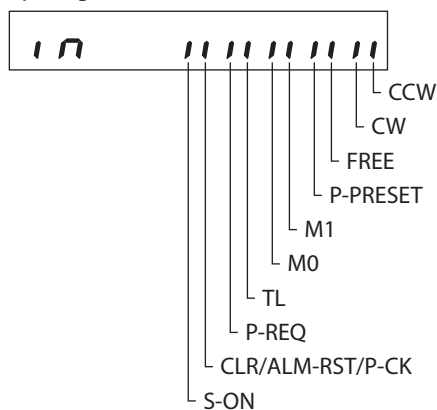

• Output signals

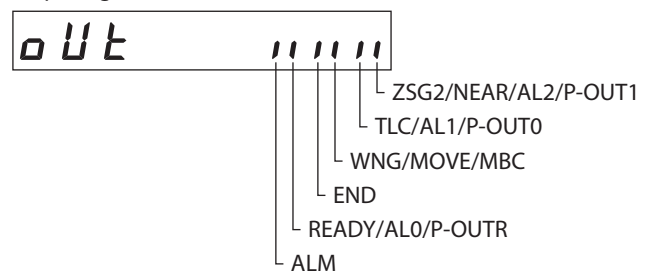

● Speed control mode

• Input signals

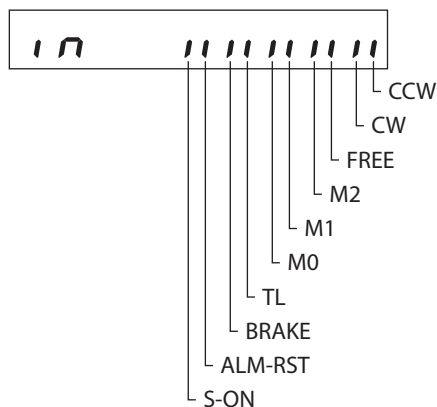

• Output signals

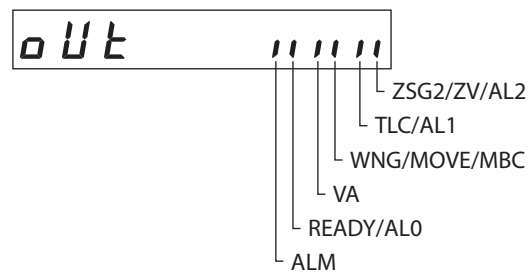

● Torque control mode

• Input signals

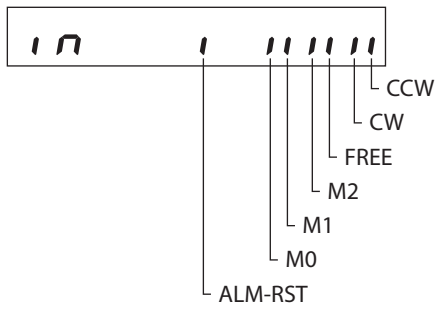

• Output signals

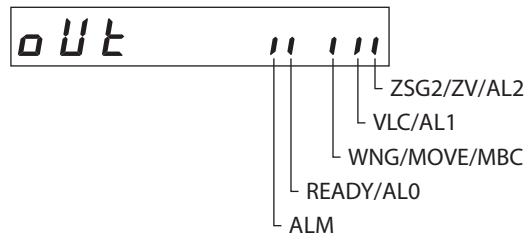

● Tension control mode

• Input signals

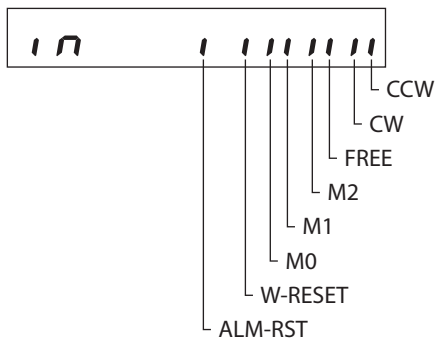

• Output signals

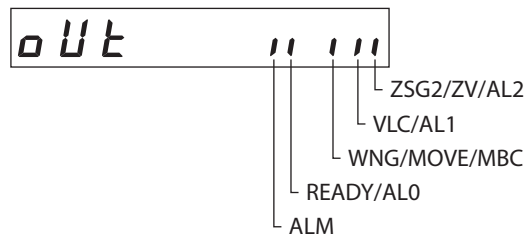

■ Monitor the analog input voltage

The analog speed input voltage and analog torque input voltage are shown. Each voltage is indicated in units of 0.1 V.

7 Data mode

Up to eight sets of motor operation data (four sets for the position control mode) can be set. Once set, the operation data is stored in the driver.

The data will not be lost even after the **OPX-2A** is disconnected from the driver.

Note Operation data has significant bearing on motor operation. Before setting any operation data, make sure you fully understand the content of the operation data.

memo If operations are limited by the edit lock function, operation data cannot be edited.

7-1 Data selection method

Select the set operation data based on a combination of ON/OFF status of the M0 to M2 inputs.

■ Position control mode

Operation data No.	M1	M0
0	OFF	OFF
1	OFF	ON
2	ON	OFF
3	ON	ON

■ Speed control mode, torque control mode, tension control mode

Operation data No.	M2	M1	M0
0	OFF	OFF	OFF
1	OFF	OFF	ON
2	OFF	ON	OFF
3	OFF	ON	ON
4	ON	OFF	OFF
5	ON	OFF	ON
6	ON	ON	OFF
7	ON	ON	ON

7-2 Setting item of operation data

memo If the value you have input is outside the setting range, "Error" will be displayed for 1 second. If this error display appears, input a different value that falls within the setting range.

■ Position control mode

Item	Description	Setting range	Initial value
Torque limit	Sets the torque limit value.	0 to 300 [%]	0
Damping frequency	Sets the damping control frequency.	7.00 to 100.00 [Hz]	30.00

■ Speed control mode

Item	Description	Setting range	Initial value
Operating speed	Sets the operating speed.	0 to 5,500 [r/min]	0
Acceleration time	Sets the time needed for the operating speed to reach 1,000 r/min from 0 r/min.	5 to 10,000 [ms/(1,000 r/min)]	100
Deceleration time	Sets the time needed for the operating speed to reach 0 r/min from 1,000 r/min.	5 to 10,000 [ms/(1,000 r/min)]	100
Torque limit	Sets the torque limit value.	0 to 300 [%]	0

■ Torque control mode

Item	Description	Setting range	Initial value
Speed limit	Sets the speed limit value.	0 to 5,500 [r/min]	0
Torque command	Sets the torque command value. The rated torque corresponds to 100 %.	0 to 300 [%]	0

■ Tension control mode

Item	Description	Setting range	Initial value
Speed limit	Sets the speed limit value.	0 to 5,500 [r/min]	0
Tension command	Sets the tension command. The rated torque corresponds to 100 %.	0 to 100 [%]	0
Material thickness *1 *2	Sets the thickness of material.	1 to 5,000 [μm]	50
Initial diameter *1 *2	Sets the initial diameter when winding or unwinding.	1 to 1,000 [mm]	500
Final diameter *1 *2	Sets the final diameter when winding or unwinding.	1 to 1,000 [mm]	1,000
Taper setting *1 *2	This function prevents excessively tight winding. As the roll diameter increases, the tension is lowered. The tension becomes constant when the taper setting is 100 %.	0 to 100 [%]	100
Core inertia moment *2	Sets the inertial moment of the core.	0.00 to 99,999.99 [$\times 10^{-4} \text{ kgm}^2$]	0
Material inertia moment *2	Sets the inertial moment of the material at the maximum material thickness.	0.00 to 99,999.99 [$\times 10^{-4} \text{ kgm}^2$]	0

*1 This parameter is set in high function mode I.

*2 This parameter is set in high function mode II.



Set the initial diameter and final diameter in a manner that satisfies the specified relationship in the applicable condition as shown below. If the magnitude correlation of the two diameters is reversed, the tension will not remain constant:

Winding: Initial diameter < Final diameter

Unwinding: Initial diameter > Final diameter

8 Test mode

8-1 Overview of the test mode

- **I/O test**

You can check the ON/OFF status of each input signal of the driver, or switch the ON/OFF status of each output signal on the **OPX-2A**. You can also check the analog input voltage and set a desired analog output voltage. There is also an I/O test function with which you can check the connection status of the driver.

- **JOG operation**

You can operate the motor using the keys on the **OPX-2A**.

- **Position preset**

You can preset the current position and Z-phase position.

- **Analog input offset**

You can offset the analog speed input and analog torque input.

- **What happens when the [SET] key is pressed while the motor is operating**

While the motor is operating, you cannot move to any lower level from the top screen of the test mode. Pressing the [SET] key will generate an error, and "oPE-Err" will be shown. Be sure to stop the motor operation before pressing the [SET] key.

oPE-Err



- Stop the motor operation before changing to the test mode.
- When you move from the top screen of the test mode to a lower level, the CW/CCW input will be disabled.
- When you move from a non-JOG-operation item to a lower level, all I/O signals and operations will be disabled.

8-2 I/O test

You can check the ON/OFF status of each input signal of the driver, or switch the ON/OFF status of each output signal on the **OPX-2A**. You can also check the analog input voltage and set a desired analog output voltage. There is also an I/O test function with which you can check the connection status of the driver.

- **Check the I/O signals**

On the I/O signal check screen, each digit on the 7-segment LED display corresponds to a signal. If the signal is ON, the corresponding digit is lit. If the signal is OFF, the digit is unlit.

Use the [↑][↓] keys to switch the ON-OFF state of the output signal. "0" is displayed when the signal is ON, while "-" is displayed when the signal is OFF.

- **Position control mode**

- Input signals

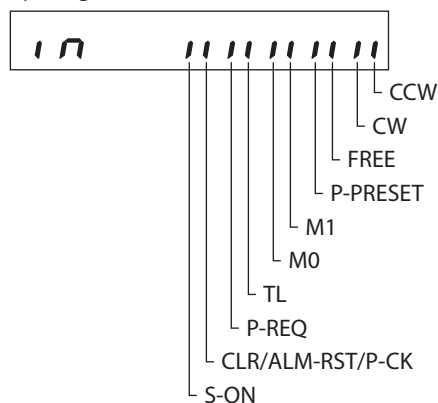

- Output signals

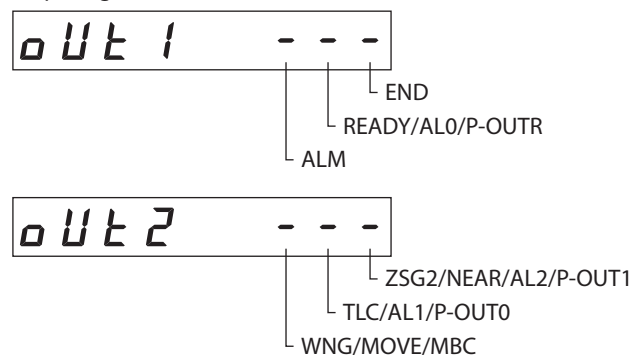

● **Speed control mode**

● Input signals

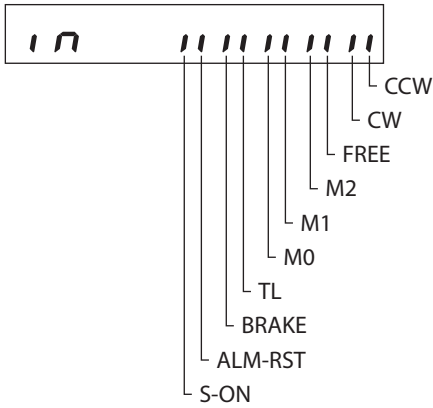

● Output signals

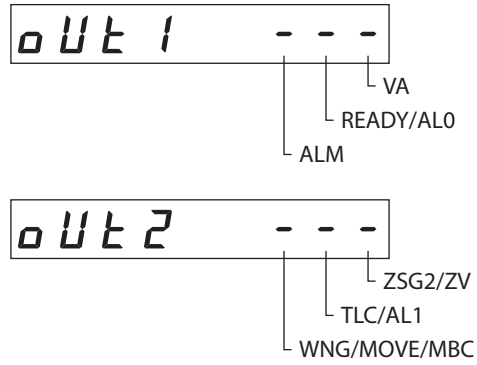

● **Torque control mode**

● Input signals

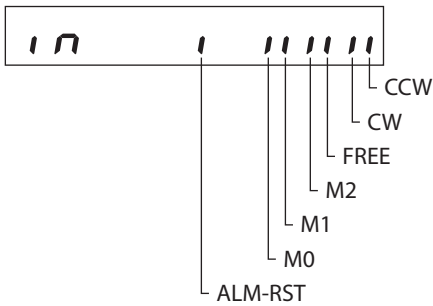

● Output signals

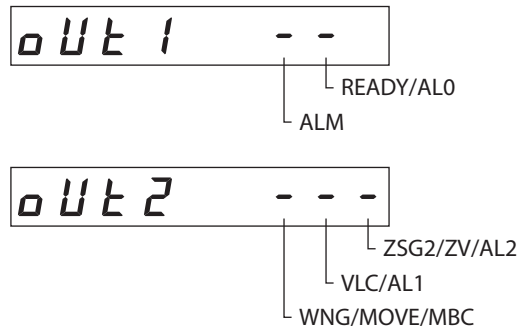

● **Tension control mode**

● Input signals

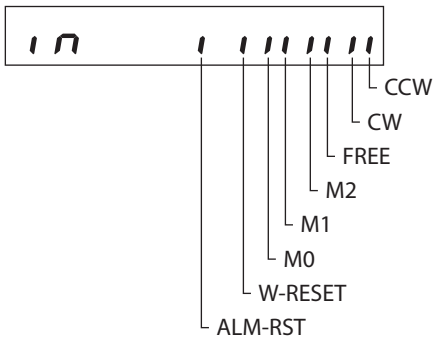

● Output signals

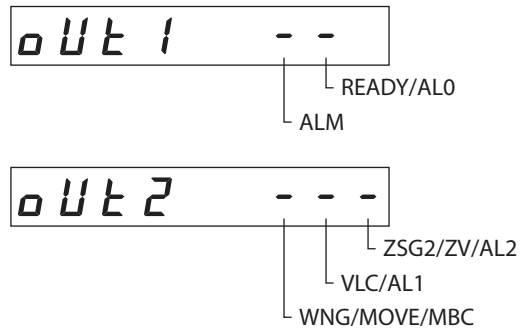

■ **Analog input test**

The analog speed input voltage and analog torque input voltage are shown. Each voltage is indicated in units of 0.1 V.

■ **Analog output test**

When an output voltage is set and the [SET] key is pressed, the specified voltage will be output from the analog monitor terminal of the driver.

The setting range is -10.0 to +10.0 V.

8-3 JOG operation

You can operate the motor using the keys on the **OPX-2A**.

Note During operation, the motor rotates at the specified operating speed while each applicable key is pressed. Before executing the operation, consider the status of the equipment and condition of its surroundings to confirm thoroughly that motor rotation will not cause any dangerous situation.

■ Position control mode, speed control mode

The motor rotates in the forward direction while [↑] is pressed.

The motor rotates in the reverse direction while [↓] is pressed.

The operating speed is the value set in the "JOG operating speed" parameter.

■ Torque control mode, tension control mode

The torque generates in the forward direction while [↑] is pressed.

The torque generates in the reverse direction while [↓] is pressed.

The torque command is the value set in the "JOG operating torque" parameter.

The tension command is the value set in the "JOG operating tension" parameter.

8-4 Preset the current position

The current position is preset by rewriting the value in the "Preset value" parameter

memo

- If operations are limited by the edit lock function, the preset function cannot be performed.
- If the preset function is performed while the absolute function is enabled, the home will be written to the driver's non-volatile memory. The non-volatile memory can be rewritten approximately 100,000 times.

8-5 Preset the Z-phase

In this operation, a Z-phase signal is output at the current position.

memo

- If operations are limited by the edit lock function, the Z-phase preset function cannot be performed.
- When Z-phase preset is performed, the Z-phase position will be tentatively written to the driver's non-volatile memory. When the power is turned on again, the Z-phase position that was written earlier will be reflected in the motor encoder. The non-volatile memory and encoder memory can be rewritten approximately 100,000 times.
- When a different motor is connected, the content of the encoder memory of the new motor will be read into the driver. Accordingly, the Z-phase position will also change to reflect the new motor.

8-6 Offset the analog speed input

This function cannot be used when the "Analog input signal automatic offset" parameter is set to "1: Enable." When a voltage of 0V is input to the analog speed input terminal and the offset function is performed, the offset voltage will be adjusted automatically and the adjusted voltage will be saved in the driver.

memo

- If operations are limited by the edit lock function, the offset function cannot be performed.
- If the offset function is performed, the offset voltage will be written to the driver's non-volatile memory. The non-volatile memory can be rewritten approximately 100,000 times.

8-7 Offset the analog torque input

This function cannot be used when the "Analog input signal automatic offset" parameter is set to "1: Enable." When a voltage of 0 V is input to the analog torque input terminal and the offset function is performed, the offset voltage will be automatically adjusted and the adjusted voltage will be saved in the driver.



- If operations are limited by the edit lock function, the offset function cannot be performed.
- If the offset function is performed, the offset voltage will be written to the driver's non-volatile memory. The non-volatile memory can be rewritten approximately 100,000 times.

9 Copy mode

9-1 Overview of the copy mode

In the copy mode, you can download data saved in the **OPX-2A** to the driver. You can also upload data saved in the driver to the **OPX-2A**.

It is also possible to verify data in the **OPX-2A** against the corresponding data in the driver, or revert driver data to their initial values.

- **Download**

Data saved in the **OPX-2A** can be copied to the driver.

- **Upload**

Data saved in the driver can be copied to the **OPX-2A**.

- **Verification**

Data in the **OPX-2A** can be verified against the corresponding parameters in the driver.

If the verification finds that the two sets of parameter match, "Good" will be shown. If the two do not match, "Error" will be shown.

- **Initializing driver data**

Data saved in the driver can be restored to the initial values.

Note Do not turn off the driver power while processing is in progress (=while the display is blinking). Doing so may damage the parameter.

memo When a system parameter has been changed, the new setting will become effective after the power is turned on again. When system parameters were changed by downloading, turn on the driver power again. If a 24 VDC power supply is used, also turn on the 24 VDC power supply again.

- **What happens when the [SET] key is pressed while the motor is operating**

While the motor is operating, you cannot move to any lower level from the top screen of the copy mode. Pressing the [SET] key will generate an error, and "oPE-Err" will be shown. Be sure to stop the motor operation before pressing the [SET] key.

oPE-Err

- **What happens when the [SET] key is pressed while the edit lock is enabled**

While the edit lock is enabled, you cannot move to any lower level from the top screen of the copy mode. Pressing the [SET] key will generate an error, and "Lock-Err" will be shown. Be sure to cancel the edit lock before pressing the [SET] key.

Lock-Err

memo

- Stop the motor operation before changing to the copy mode.
- When you move from the top screen of the copy mode to a lower level, the CW/CCW input will be disabled.

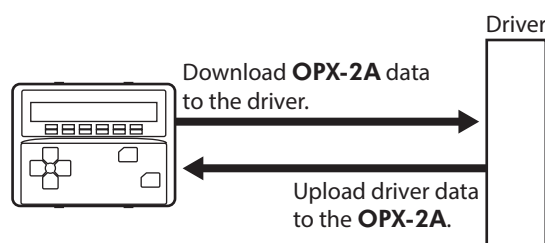

9-2 Error of the copy mode

If an error occurs in download or verification, the error code will blink on the display. At this time, the processing will not be executed and the display will return to the top screen.

Blinking display	Description	Action
<code>Prod-Err</code>	There is a discrepancy between the selected product series and the data being processed.	<ul style="list-style-type: none"> • Check the product series. • Check the data bank number on the OPX-2A.
<code>HEAD-Err</code> <code>bcc-Err</code>	An error occurred while processing.	Execute the processing again. If the same error occurs, the parameters saved in the OPX-2A may have damaged. Upload and set the parameters of the OPX-2A again.
<code>no-data</code>	The specified data bank number does not contain data.	Check the data bank number.
<code>ctl-Err</code>	The control mode of the driver is different from that of the OPX-2A .	Check the control mode of the driver.
<code>data-Err</code>	An error occurred while data was being written.	Execute the download again.

8 Monitor function

This part explains the functions to check the motor conditions, such as motor position, detected speed and detected torque. The monitor functions described herein are available in all control modes.

◆ Table of contents

1	Encoder output.....	196
1-1	Resolution of encoder output.....	196
2	Analog monitor.....	197
2-1	Analog speed monitor.....	197
2-2	Analog torque monitor.....	198



1 Encoder output

The motor position can be checked by counting the numbers of ASG output and BSG output pulses. The BSG output has a 90° phase difference with respect to the ASG output. The ZSG1 output and ZSG2 output will turn ON every time the motor rotates by one revolution.

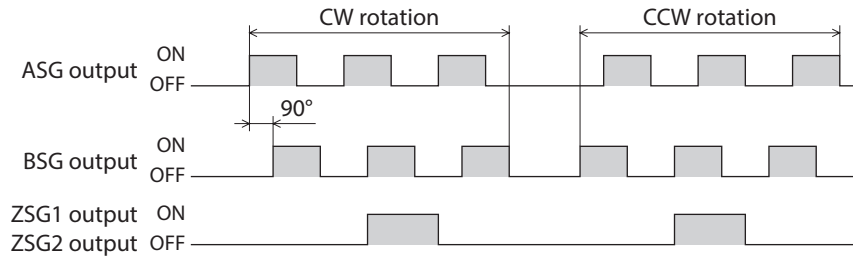

- There is a maximum delay of 0.1 ms between pulse output and motor movement. Accordingly, use the ASG output and BSG output for checking the position where the motor is stopped.
- The minimum output band is approximately 400 μs for both the ZSG1 output and ZSG2 output.
- If the ZSG1 output and ZSG2 output are used, keep the frequencies of the ASG output and BSG output to below 1 kHz. If the ASG and BSG frequencies are 1 kHz or higher, the ZSG1 and ZSG2 signals may not be output properly.

1-1 Resolution of encoder output

You can set a desired resolution of encoder output using the system parameters for electronic gear A of encoder output and electronic gear B of encoder output.

However, the calculated value must fall within the setting range specified below:

- Resolution setting range: 100 to 10,000 P/R
- Initial value: 1,000 P/R

$$\text{Encoder output resolution [P/R]} = 1,000 \times \frac{\text{Encoder output electronic gear B}}{\text{Encoder output electronic gear A}}$$

Setting example

Resolution (P/R)	Electronic gear A of encoder output	Electronic gear B of encoder output
1,000	1 (initial value)	1 (initial value)
100	10	1
360	100	36

2 Analog monitor

The detected speed and detected torque can be output as voltages from pin No.7 (V-MON output) and pin No.9 (T-MON output) of the analog I/O connector (CN6), respectively.

Use this function if you want the output voltage to be monitored by a programmable controller, etc.

Output voltage: ± 10 VDC

2-1 Analog speed monitor

Set the analog speed monitor using the following application parameters:

- Analog speed monitor maximum value Sets the maximum value of detected speed to be monitored.
- Analog speed monitor maximum voltage Sets the voltage at which to detect the maximum speed.
- Analog speed monitor offset voltage This parameter is set when the home of output voltage is to be offset.

Setting example	Analog speed monitor maximum value	Analog speed monitor maximum voltage	Analog speed monitor offset voltage	Description
①	6,000 r/min	10 V	0 V	When the detected speed is 6,000 r/min, 10 V is output.
②	3,000 r/min	3 V	0 V	When the detected speed is 3,000 r/min, 3 V is output. The voltage does not rise above 3 V even when the detected speed exceeds 3,000 r/min.
③	3,000 r/min	10 V	0 V	When the detected speed is 3,000 r/min, 10 V is output.
④	6,000 r/min	10 V	1 V	The home of output voltage becomes 1 V.

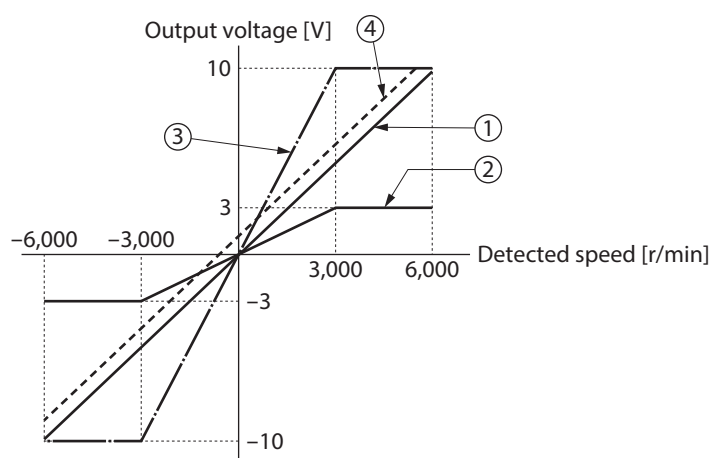

Even when a speed above the maximum voltage is detected, the output will not exceed the maximum voltage.

2-2 Analog torque monitor

Set the analog torque monitor using the following application parameters:

- Analog torque monitor maximum value..... Sets the maximum value of detected torque to be monitored.
- Analog torque monitor maximum voltage..... Sets the voltage at which to detect the maximum torque.
- Analog torque monitor offset voltage..... This parameter is set when the home of output voltage is to be offset.

Setting example	Analog torque monitor maximum value	Analog torque monitor maximum voltage	Analog torque monitor offset voltage	Description
①	300 %	10 V	0 V	When the detected torque is 300 %, 10 V is output.
②	150 %	3 V	0 V	When the detected torque is 150 %, 3 V is output. The voltage does not rise above 3 V even when the detected torque exceeds 150 %.
③	150 %	10 V	0 V	When the detected torque is 150 %, 10 V is output.
④	300 %	10 V	1 V	The home of output voltage becomes 1 V.

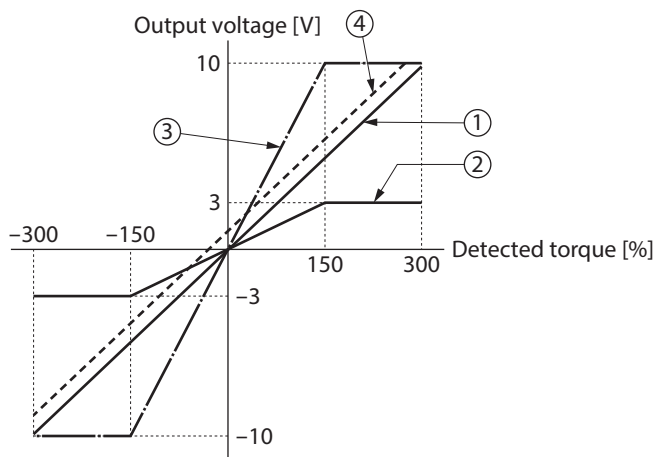

Even when a torque above the maximum voltage is detected, the output will not exceed the maximum voltage.

9 Inspection, troubleshooting and remedial actions

This part explains the periodical inspection methods as well as confirmation items and remedial actions when problems have happened.

◆ Table of contents

1	Inspection	200
2	Alarms and warnings	201
	2-1 Alarms.....	201
	2-2 Warnings.....	207
	2-3 Timing charts	208
3	Troubleshooting and remedial actions	210



1 Inspection

It is recommended that periodic inspections be conducted for the items listed below after each operation of the motor. If an abnormal condition is noted, discontinue any use and contact your nearest Oriental Motor sales office.

■ Inspection item

- Check if any of the motor mounting screws is loose.
- Check if an unusual noise is generated from a bearing (ball bearings) of the motor.
- Check if the motor output shaft (gear output shaft) and the load shaft are out of alignment.
- Check if a damage or stress is applied on the cable.
- Check if the connection part between the motor and driver is loose.
- Check if the openings in the driver are clogged.
- Check if any of the screws having installed the driver is loose.
- Check if any of the connection parts of the connector is loose.
- Check if the driver has unusual smells or appearance defects.



The driver uses semiconductor components. Static electricity may damage the semiconductor components of the driver, so be extremely careful when handling them.

2 Alarms and warnings

The driver provides alarms that are designed to protect the driver from overheating, poor connection, misoperation, etc. (protective functions), as well as warnings that are output before the corresponding alarms generate (warning functions).

2-1 Alarms

When an alarm generates, the ALM output will turn OFF and the motor will stop.

When the application parameter for alarm code output is set to "1: Enable," the READY output, TLC/VLC output and ZSG2/NEAR/ZV output will automatically switch to the AL0 output, AL1 output and AL2 output, respectively. However, the current position output function is given priority when the P-REQ input is ON in the position control mode. In this case, alarm codes are not output. Also, the ALM-RST input cannot be used because the CLR/ALM-RST/P-CK input functions as the P-CK input.

When an alarm generates, the ALARM LED will blink. The cause of the alarm can be checked by counting the number of times the ALARM LED blinks.

Present alarms can be checked using the **MEXE02** or the **OPX-2A**.

You can also check the records of up to 10 most recent alarms starting from the latest one, or clear the alarm records.

Example: Overvoltage alarm (Number of blinks: 3)

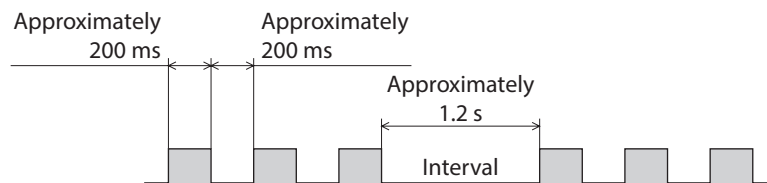

Some alarms cause the motor current to be cut off, resulting in the motor losing its holding torque. In the case of an electromagnetic brake motor, the electromagnetic brake will actuate to hold the load in position.

Alarm reset

Perform one of the reset operations specified below.

Before resetting an alarm, always remove the cause of the alarm and ensure safety.

- Turn the ALM-RST input to ON and then OFF. (The alarm will be reset at the OFF edge of the input.)
- Perform the alarm reset using the **MEXE02** or the **OPX-2A**.
- Turn on the power supply again.



- Some alarms cannot be reset with the ALM-RST input or alarm reset functions provided by the **MEXE02** or the **OPX-2A**. Check which alarms fall under this category in the tables provided on the following pages. To reset these alarms, the power must be turned on again. If a 24 VDC power supply is connected, also turn on the 24 VDC power supply again.
- The absolute position loss alarm cannot be reset with the ALM-RST input alone. Refer to p.80 for details on the method to reset this alarm.

■ Descriptions of alarms

Alarm type	Number of times the ALARM LED blinks	Alarm code output			Alarm code	Motor operation upon alarm *	Reset using the ALM-RST input/ OPX-2A/MEXE02
		AL2	AL1	AL0			
Overheat protection	2	OFF	ON	OFF	21h	×	Possible
Motor overheat protection					26h	×	Not possible
Overload					30h	×	Possible
Overspeed					31h	×	Possible
Command pulse error					34h	×	Possible
Regeneration resistor overheat					51h	×	Not possible
Overvoltage protection	3	OFF	ON	ON	22h	×	Not possible
Main power supply error					23h	×	Possible
Undervoltage					25h	×	Possible
Excessive position deviation	4	ON	OFF	OFF	10h	×	Possible
Overcurrent protection	5	ON	OFF	ON	20h	×	Not possible

Cause	Action
The internal temperature of the driver exceeded approximately 85°C (185 °F).	Reconsider the ventilation condition inside an enclosure.
The motor temperature reached approximately 85°C (185 °F).	<ul style="list-style-type: none"> • Check the heat dissipation condition of the motor. • Reconsider the ventilation condition of the surroundings.
A torque exceeding the rated torque was applied.	<ul style="list-style-type: none"> • Reduce the load or increase the acceleration/deceleration time. • Check the cable connection. • Check if the electromagnetic brake is released during operation.
The detected motor speed exceeded 6,000 r/min.	<ul style="list-style-type: none"> • Keep the speed of the motor output shaft to not more than 5,500 r/min. • If the speed is overshooting due to insufficient gain adjustment, readjust the gain.
The command pulse frequency exceeded the specified value.	<ul style="list-style-type: none"> • Set the command pulse frequency to 500 kHz or less. • Check the electronic gear setting and reduce the speed of the motor output shaft to 5,500 r/min or less.
<ul style="list-style-type: none"> • The regeneration resistor is not connected correctly. • The regeneration resistor is overheating. • The heat sink is overheating. 	<ul style="list-style-type: none"> • If an external regeneration resistor is connected, connect the thermostat outputs of the regeneration resistor correctly to the regeneration resistor thermal input terminals (TH1 and TH2 terminals of CN1). • If the internal regeneration resistor is used, short the regeneration resistor thermal input terminals (TH1 and TH2 terminals of CN1). • The current consumption of the regeneration resistor exceeds the allowable level. Reconsider the load condition and operating conditions. • Check if the built-in cooling fan operates (for the NXD75-S only).
<ul style="list-style-type: none"> • 200-230 VAC was applied to a product specified for 100-115 VAC. • A large inertial load was stopped abruptly, or up/down operation was performed without connecting a regeneration resistor. • The regeneration resistor is not connected correctly. • The DC voltage of the main power supply became approximately 400 V or higher. 	<ul style="list-style-type: none"> • Check the input voltage of the main power supply. • If this alarm generates during acceleration/deceleration, the current consumption of the regeneration resistor may have exceeded the allowable level. Reconsider the load condition and operating conditions. • If the internal regeneration resistor is used, switch to an external regeneration resistor.
The motor was started when the main power was cut off.	Check if the main power is input properly.
The main power supply was shut off momentarily or a voltage shortage was generated.	Check the input voltage of the main power supply.
<ul style="list-style-type: none"> • The deviation between the command position and actual position at the motor output shaft exceeded the value set in the excessive position deviation alarm parameter. (Initial value: 10 rev) • The load is large or the acceleration/deceleration time is short. 	<ul style="list-style-type: none"> • Reduce the load or increase the acceleration/deceleration time. • If the torque limit function is used, increase the torque limit value.
The motor, cable or driver output circuit was shorted.	Turn off the power and check the motor, cable and driver output circuit for shorting, and then turn on the power supply again.

Alarm type	Number of times the ALARM LED blinks	Alarm code output			Alarm code	Motor operation upon alarm *	Reset using the ALM-RST input/ OPX-2A/MEXE02
		AL2	AL1	AL0			
Position range error	7	ON	ON	ON	32h	○	Possible
Absolute position loss					33h	○	Possible
ABS not supported					47h	○	Possible
No battery					48h	○	Possible
Electronic gear setting error					71h	×	Not possible
Sensor error during operation	8	OFF	OFF	OFF	28h	×	Not possible
Encoder communication error					2Ah	×	Not possible
Sensor error during initialization					42h	×	Not possible
Rotor rotation during initialization					43h	×	Not possible
Encoder EEPROM error					44h	×	Not possible
Motor combination error					45h	×	Not possible
EEPROM error	9	OFF	OFF	ON	41h	×	Not possible
CPU error	Lit	OFF	OFF	OFF	F0h	×	Not possible

* The symbols in the "motor operation upon alarm" field are explained below.

- ×: When an alarm generates, the motor current will be cut off and the motor will lose its holding torque. In the case of an electromagnetic brake motor, the motor will become unexcited and the electromagnetic brake will hold the load automatically.
- : Even when an alarm generates, the motor current will not be cut off and the motor position will be held.

Cause	Action
<ul style="list-style-type: none"> The command position exceeded the coordinate control range (–2,147,483,648 to 2,147,483,647). The multi-rotation data for internal encoder coordinates exceeded the coordinate control range (–32,768 to 32,767). (This alarm generates when the absolute system function is used in the position control mode.)	<ul style="list-style-type: none"> Set the command position so that the moving range will remain inside the coordinate control range. If this alarm generates inside the coordinate control range, the multi-rotation data for internal encoder coordinates exceeds the coordinate control range. Turn off the power, disconnect the encoder cable, connect it again after approximately 30 seconds, and then turn on the power supply again.
<ul style="list-style-type: none"> The power was turned on for the first time after connecting the battery. No battery is connected, the battery cable is disconnected, or the battery has been consumed. The encoder cable came off. The position range error alarm was reset. (This alarm generates when the absolute system function is used in the position control mode.)	<ul style="list-style-type: none"> Perform position preset. Check the battery connection, or replace the battery.
The battery was detected when the absolute function was disabled in the position control mode.	If the absolute system function is used, enable the absolute function. If the absolute system function is not used, disconnect the battery.
No battery was detected or the battery cable was disconnected when the absolute function was enabled.	Check the connection condition of the battery.
The power was turned on when the resolution set by the electronic gear and encoder output electronic gear was outside the specified range.	Set the electronic gear and encoder output electronic gear correctly, then turn on the power supply again.
An encoder error was detected during operation.	Turn off the power, check the connection between the encoder and driver, then turn on the power supply again.
A communication error occurred between the driver and encoder.	Turn off the power, check the connection between the encoder and driver, then turn on the power supply again.
An encoder error was detected when the power was turned on.	Turn off the power, check the connection between the encoder and driver, then turn on the power supply again.
The motor output shaft rotated by 1/40th of a revolution during the initialization following a power on.	Prevent the motor output shaft from rotating due to an external force when the power is turned on.
Data stored in the encoder communication circuit was damaged.	Turn off the power, check the connection between the encoder and driver, then turn on the power supply again.
A motor not supported by the driver is connected.	Check the driver model and motor model, and use the driver and motor in the correct combination.
Data stored in the driver was damaged.	Initialize the parameters and operation data using the MEXE02 or the OPX-2A .
CPU malfunctioned.	Turn on the power supply again.

■ Characteristics of the overload alarm

How long it takes to detect an overload alarm varies depending on the torque.

Reference overload detection time

Continuous output torque	Overload detection time
100 %	No detection
125 %	Approximately 10 s
150 %	Approximately 4 s
250 %	Approximately 1 s
300 %	Approximately 0.5 s

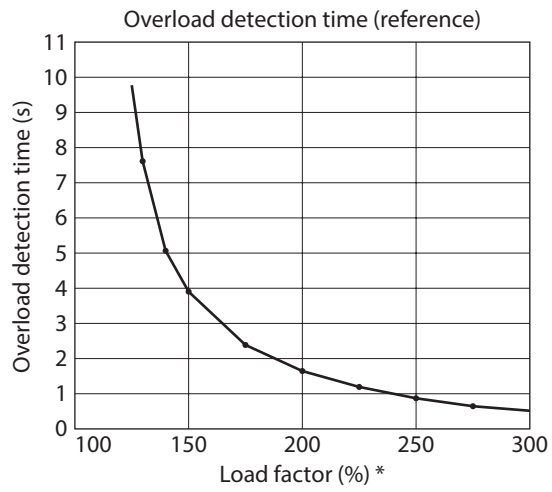

* The load factor is 100 % when the rated torque is output.

2-2 Warnings

When a warning generates, the WNG output will turn ON. The motor will continue to operate. Once the cause of the warning is removed, the WNG output will turn OFF automatically. Present warnings can be checked using the **MEXE02** or the **OPX-2A**. You can also check the records of up to 10 most recent warnings starting from the latest one, or clear the warning records.



You can also clear the warning records by turning off the driver power.

■ Descriptions of warnings

Warning type	Warning code	Cause	Action
Excessive position deviation	10h	<ul style="list-style-type: none"> The deviation between the command position and actual position at the motor output shaft exceeded the value set in the excessive position deviation warning parameter. (Initial value: 9 rev) The load is large or the acceleration/ deceleration time is short. 	<ul style="list-style-type: none"> Reduce the load or increase the acceleration/deceleration time. If the torque limit function is used, increase the torque limit value.
Overheat	21h	The internal temperature of the driver exceeded the value set in the overheat warning parameter. [Initial value: 80 °C (176 °F)]	Reconsider the ventilation condition inside an enclosure.
Overvoltage	22h	<ul style="list-style-type: none"> The DC voltage of the main power supply exceeded the value set in the overvoltage warning parameter. (Initial value: 390 V) A large inertial load was stopped abruptly, or up/down operation was performed without connecting a regeneration resistor. 	<ul style="list-style-type: none"> Check the input voltage of the main power supply. If this warning generates during operation, reduce the load or increase the acceleration/deceleration time. If the internal regeneration resistor is used, switch to an external regeneration resistor.
Main power supply	23h	The S-ON input was turned ON when the main power was cut off.	<ul style="list-style-type: none"> Do not turn the S-ON input ON while the main power is cut off. Check the S-ON signal logic.
Undervoltage	25h	<ul style="list-style-type: none"> The DC voltage of the main power supply became lower than the value set in the undervoltage warning parameter. (Initial value: 125 V) The main power was cut off momentarily or the voltage became low. 	Check the input voltage of the main power supply.
Low battery voltage	27h	The battery discharged and its voltage dropped to 3.2 V or below.	Replace the battery.
Overload	30h	<ul style="list-style-type: none"> The generated torque exceeded the value set in the overload warning parameter. (Initial value: 90 %) The load is large or the acceleration/ deceleration time is short. 	<ul style="list-style-type: none"> Reduce the load, or increase the acceleration/deceleration time. Check the cable connection. Check if the electromagnetic brake is released during operation.
Overspeed	31h	The detected motor speed exceeded the value set in the overspeed warning parameter. (Initial value: 5,800 r/min)	<ul style="list-style-type: none"> Check the electronic gear setting and reduce the speed of the motor output shaft to the value set in the parameter or less. If the speed is overshooting due to insufficient gain adjustment, readjust the gain.
Absolute position loss	33h	The battery or encoder was disconnected.	Perform position preset.

Warning type	Warning code	Cause	Action
Electronic gear setting error	71h	The resolution set by the electronic gear and encoder output electronic gear became outside the specified range.	Set the electronic gear and encoder output electronic gear correctly, then turn on the power supply again.

2-3 Timing charts

■ ALM output/WNG output

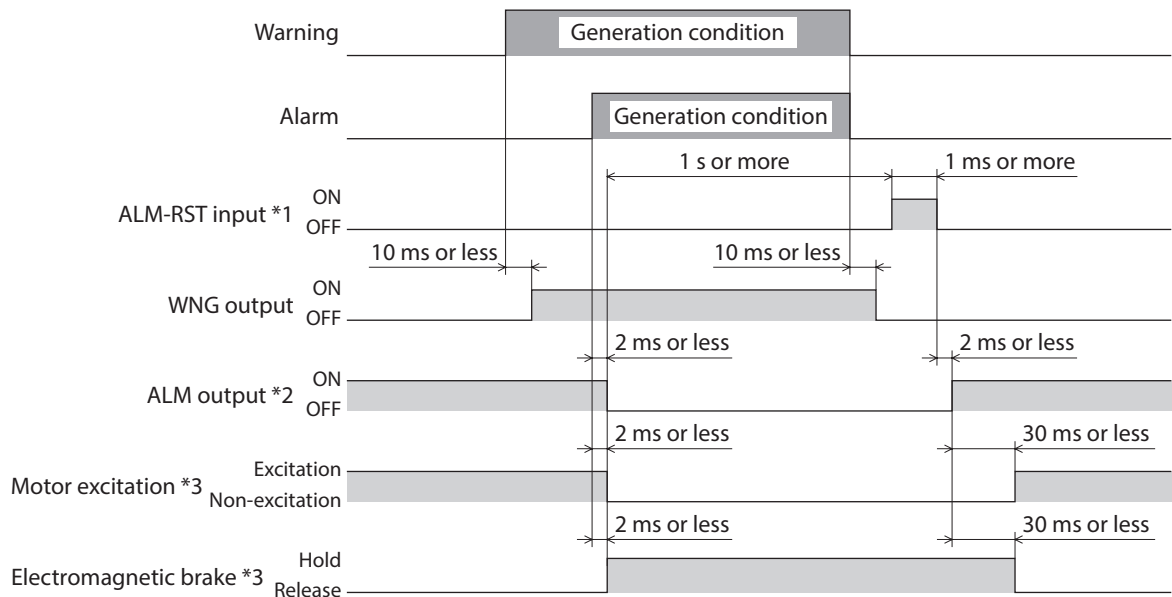

- *1 An alarm is reset at the ON→OFF edge. Before resetting an alarm, be sure to remove the cause of the alarm, and then input the signal only once.
- *2 The signal logic is contact B (normally closed). This output remains ON in a normal state, and will turn OFF if an alarm generates.
- *3 Assuming generation of an alarm that stops motor excitation.

■ AL0 output /AL1 output/AL2 output

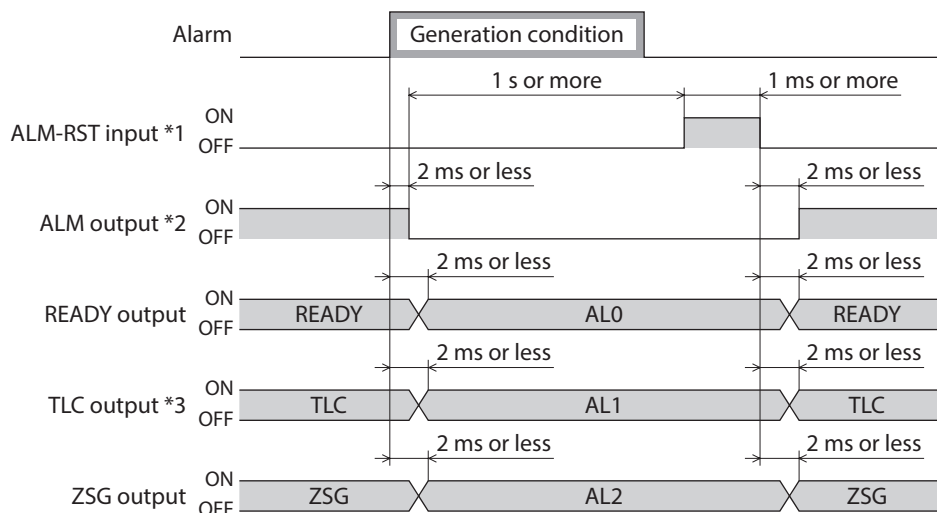

*1 An alarm is reset at the ON→OFF edge. Before resetting an alarm, be sure to remove the cause of the alarm, and then input the signal only once.

*2 The signal logic is contact B (normally closed). This output remains ON in a normal state, and will turn OFF if an alarm generates.

*3 In the position control mode and speed control mode, the TLC output becomes effective. In the torque control mode and tension control mode, the VLC output becomes effective.

■ Notifying the generation of an alarm: ALM output

When an alarm generates, the ALM output will turn OFF. At the same time, the ALARM LED on the driver will start blinking and the motor current will be cut off, causing the motor to stop (*). In the case of an electromagnetic brake motor, the electromagnetic brake will actuate to hold the load in position.

Set the programmable controller to stop the motor operation command upon detection of an OFF status of the ALM output.

The cause of the generated alarm can be checked by counting the number of times the ALARM LED blinks.

* Some alarms do not cut off the current.

■ Notifying the generation of a warning: WNG output

When a warning generates, the WNG output will turn ON. You can cause a warning to generate prior to a corresponding alarm. The generation conditions of warnings can be changed using the **MEXE02** or the **OPX-2A**.

■ Notifying the content of an alarm using an alarm code: AL0/AL1/AL2 outputs

When the application parameter for alarm code output is set to "1: Enable," the READY output, TLC/VLC output and ZSG2/NEAR/ZV output will automatically switch to the AL0 output, AL1 output and AL2 output, respectively, upon generation of an alarm. The generated alarm can be checked by the ON/OFF statuses of these signals.

3 Troubleshooting and remedial actions

During motor operation, the motor or driver may fail to function properly due to an improper speed setting or wiring. When the motor cannot be operated correctly, refer to the contents provided in this section and take appropriate action. If the problem persists, contact your nearest Oriental Motor sales office.

Phenomenon	Possible cause	Remedial action
<ul style="list-style-type: none"> The motor is not excited. The motor can be moved by hand. 	The S-ON input is being OFF. *1 *2	<ul style="list-style-type: none"> Turn the S-ON input ON and confirm that the motor will be excited. Check the setting of the application parameter for S-ON signal logic.
	The TL input was turned ON when the torque limit value was set to 0 %.	<ul style="list-style-type: none"> Set an appropriate torque limit value. Keep the TL input OFF when the torque limit value is set to 0 %.
	The FREE input is being ON.	Turn the FREE input OFF.
The motor does not operate.	The BRAKE input is being OFF. *3	<ul style="list-style-type: none"> Turn the BRAKE input ON. Check the setting of the application parameter for BRAKE signal logic.
	The CLR input is being ON. *1	Turn the CLR input OFF.
	The CW input or CCW input is not connected properly.	<ul style="list-style-type: none"> Check the connection between the controller and driver. Check the pulse signal specifications (voltage, width). *1
	The CW input and CCW input are being ON simultaneously in the 2-pulse input mode. *1	Each pulse signal input should specify either the CW input or CCW input, but not both. Make sure the terminal not receiving the signal input remains OFF.
	The pulse signal is connected to DIR input in the 1-pulse input mode. *1	Connect the pulse signal to the PLS input.
	The VL input was turned ON when the speed limit value was set to 0 r/min. *4	Set an appropriate speed limit value.
	An electromagnetic brake motor is used and the electromagnetic brake is not released.	Connect a 24 VDC power supply to the CN1 input terminal for 24 VDC power supply.
	The motor rotates in the direction opposite to the specified direction.	The CW input and CCW input are connected in reverse in the 2-pulse input mode. *1
The DIR input is set in reverse in the 1-pulse input mode. *1		Turn the DIR input ON to cause the motor to rotate in CW direction, and turn the input OFF to cause the motor to rotate in CCW direction.
The system parameter for motor rotation direction is set wrongly.		Check the setting of the motor rotation direction parameter.
Motor operation is unstable.	Pulse signals are not connected properly. *1	<ul style="list-style-type: none"> Check the connection between the controller and driver. Check the pulse signal specifications (voltage, width).
The electromagnetic brake does not hold the load.	The FREE input is being ON.	Turn the FREE input OFF.
The electromagnetic brake is not released.	24 VDC power is not input.	Connect a 24 VDC power supply to the CN1 input terminal for 24 VDC power supply.

*1 In the position control mode.

*2 In the speed control mode when the system parameter for operation selection after stopping in speed control mode is set to "1: Servo lock."

*3 In the speed control mode.

*4 In the torque control mode or tension control mode.



I/O signals can be monitored using the **MEXE02** or the **OPX-2A**. Use to check the wiring condition of the I/O signals.

10 Cables and accessories

◆ Table of contents

1	Cables	214
1-1	Connection cable sets/extension cable sets	214
1-2	Communication cable for the support software	219
1-3	Driver cables	219
2	Accessories.....	220
2-1	Wiring support tools.....	220
2-2	Setting tool	220
2-3	Other accessory.....	220



1 Cables

1-1 Connection cable sets/extension cable sets

The cable included with the **NX** Series is all you need to connect the motor and driver. Take note, however, that if you wish to connect the motor and driver over a distance of 3 m (9.8 ft.) or more, the included cable is not long enough and you must use a connection cable set or extension cable set. When installing the motor on a moving part, use a flexible cable offering excellent flexibility.

■ System configuration

● Extending the wiring length using a connection cable set

Do not use the included cable.

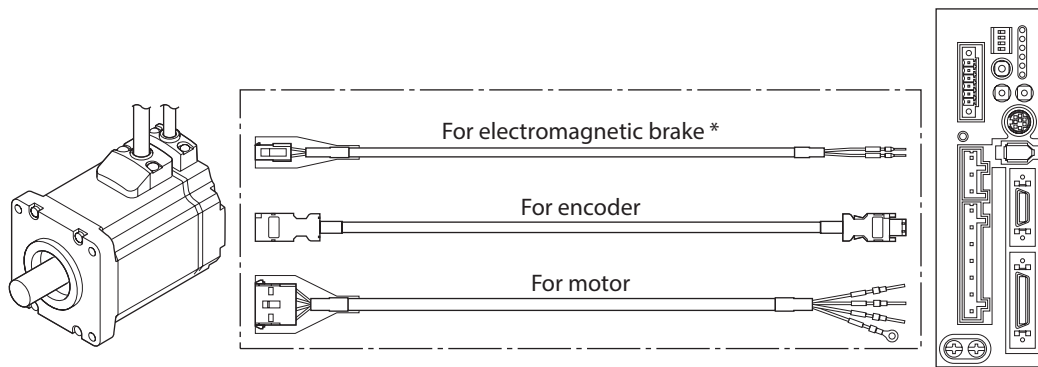

* Only when the motor is of electromagnetic brake type.

● Extending the wiring length using an extension cable set

Connect an extension cable to the included cable.

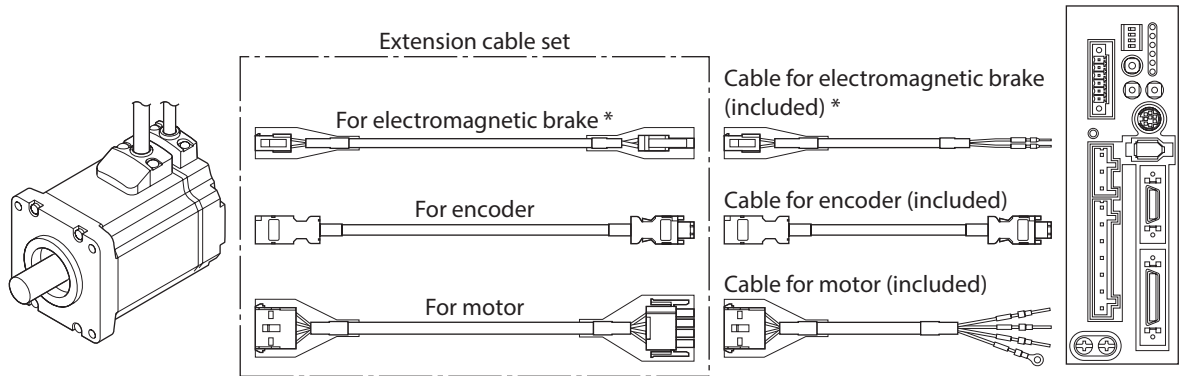

* Only when the motor is of electromagnetic brake type.

memo When extending the wiring length by connecting an extension cable to the included cable, keep the total cable length to 20 m (65.6 ft.) or less.

■ Connection cable sets

These are cable sets needed when a motor and driver are connected.
Each set consists of two cables, one for motor and the other for encoder.
The cable set for electromagnetic brake motor consists of three cables, one each for motor, encoder and electromagnetic brake.

For standard motors

Model	Length [m (ft.)]
CC050VNF	5 (16.4)
CC070VNF	7 (23)
CC100VNF	10 (32.8)
CC150VNF	15 (49.2)
CC200VNF	20 (65.6)

For electromagnetic brake motors

Model	Length [m (ft.)]
CC050VNFB	5 (16.4)
CC070VNFB	7 (23)
CC100VNFB	10 (32.8)
CC150VNFB	15 (49.2)
CC200VNFB	20 (65.6)

● Pin assignments of cable for motor connector

Pin No.	Color	Lead size
1	Red	AWG16 (1.25 mm ²)
2	White	
3	Black	
4	Green/yellow	

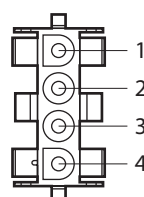

Model: 350780-1
(TE Connectivity)

● Pin assignments of cable for encoder connectors

Pin No.	Color	Lead size
1	Green	AWG18 (0.75 mm ²)
2	Black	
3	Red	AWG24 (0.2 mm ²)
4	White	AWG18 (0.75 mm ²)
5	Yellow	AWG24 (0.2 mm ²)
6	Brown	

● Motor side

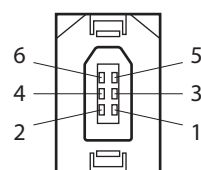

Model: 54280-0609
(Molex Incorporated)

● Driver side

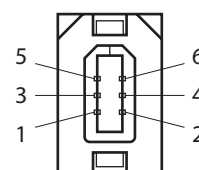

Model: 55100-0670
(Molex Incorporated)

● Pin assignments of cable for electromagnetic brake connector

Pin No.	Color	Lead size
1	White	AWG20 (0.5 mm ²)
2	Black	

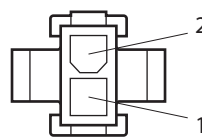

Model: 5559-02P-210
(Molex Incorporated)

Flexible connection cable sets

These are cable sets offering excellent flexibility needed when a motor and driver are connected. Each set consists of two cables, one for motor and the other for encoder. The cable set for electromagnetic brake motor consists of three cables, one each for motor, encoder and electromagnetic brake.

For standard motors

Model	Length [m (ft.)]
CC010VNR	1 (3.3)
CC020VNR	2 (6.6)
CC030VNR	3 (9.8)
CC050VNR	5 (16.4)
CC070VNR	7 (23)
CC100VNR	10 (32.8)
CC150VNR	15 (49.2)
CC200VNR	20 (65.6)

For electromagnetic brake motors

Model	Length [m (ft.)]
CC010VNRB	1 (3.3)
CC020VNRB	2 (6.6)
CC030VNRB	3 (9.8)
CC050VNRB	5 (16.4)
CC070VNRB	7 (23)
CC100VNRB	10 (32.8)
CC150VNRB	15 (49.2)
CC200VNRB	20 (65.6)

Pin assignments of cable for motor connector

Pin No.	Color	Lead size
1	Red	AWG17 (1.25 mm ²)
2	White	
3	Black	
4	Green/yellow	

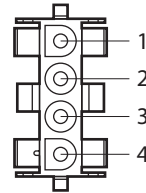

Model: 350780-1
(TE Connectivity)

Pin assignments of cable for encoder connectors

Pin No.	Color	Lead size
1	Green	AWG19 (0.75 mm ²)
2	Black	
3	Red	AWG25 (0.2 mm ²)
4	White	AWG19 (0.75 mm ²)
5	Yellow	AWG25 (0.2 mm ²)
6	Brown	

Motor side

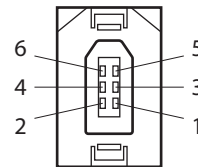

Model: 54280-0609
(Molex Incorporated)

Driver side

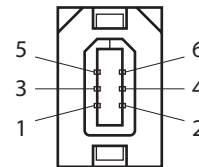

Model: 55100-0670
(Molex Incorporated)

Pin assignments of cable for electromagnetic brake connector

Pin No.	Color	Lead size
1	White	AWG21 (0.5 mm ²)
2	Black	

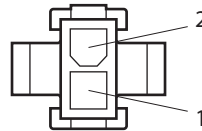

Model: 5559-02P-210
(Molex Incorporated)

■ Extension cable sets

These are cable sets needed when the wiring distance between a motor and driver is extended.

Each set consists of two cables, one for motor and the other for encoder.

The cable set for electromagnetic brake motor consists of three cables, one each for motor, encoder and electromagnetic brake.

For standard motors

Model	Length [m (ft.)]
CC010VNFT	1 (3.3)
CC020VNFT	2 (6.6)
CC030VNFT	3 (9.8)
CC050VNFT	5 (16.4)
CC070VNFT	7 (23)
CC100VNFT	10 (32.8)
CC150VNFT	15 (49.2)

For electromagnetic brake motors

Model	Length [m (ft.)]
CC010VNFBT	1 (3.3)
CC020VNFBT	2 (6.6)
CC030VNFBT	3 (9.8)
CC050VNFBT	5 (16.4)
CC070VNFBT	7 (23)
CC100VNFBT	10 (32.8)
CC150VNFBT	15 (49.2)

● Pin assignments of cable for motor connectors

Pin No.	Color	Lead size
1	Red	AWG16 (1.25 mm ²)
2	White	
3	Black	
4	Green/yellow	

● Motor side

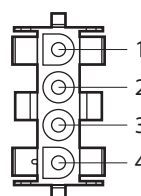

Model: 350780-1
(TE Connectivity)

● Driver side

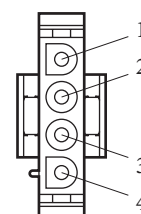

Model: 350779-1
(TE Connectivity)

● Pin assignments of cable for encoder connectors

Pin No.	Color	Lead size
1	Green	AWG18 (0.75 mm ²)
2	Black	
3	Red	AWG24 (0.2 mm ²)
4	White	AWG18 (0.75 mm ²)
5	Yellow	AWG24 (0.2 mm ²)
6	Brown	

● Motor side

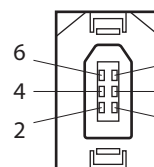

Model: 54280-0609
(Molex Incorporated)

● Driver side

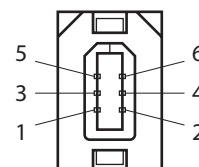

Model: 55100-0670
(Molex Incorporated)

● Pin assignments of cable for electromagnetic brake connectors

Pin No.	Color	Lead size
1	White	AWG20 (0.5 mm ²)
2	Black	

● Motor side

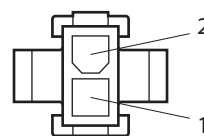

Model: 5559-02P-210
(Molex Incorporated)

● Driver side

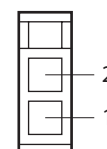

Model: 5557-02R-210
(Molex Incorporated)

Flexible extension cable sets

These are cable sets offering excellent flexibility needed when the wiring distance between a motor and driver is extended.

Each set consists of two cables, one for motor and the other for encoder.

The cable set for electromagnetic brake motor consists of three cables, one each for motor, encoder and electromagnetic brake.

For standard motors

Model	Length [m (ft.)]
CC010VNRT	1 (3.3)
CC020VNRT	2 (6.6)
CC030VNRT	3 (9.8)
CC050VNRT	5 (16.4)
CC070VNRT	7 (23)
CC100VNRT	10 (32.8)
CC150VNRT	15 (49.2)

For electromagnetic brake motors

Model	Length [m (ft.)]
CC010VNRBT	1 (3.3)
CC020VNRBT	2 (6.6)
CC030VNRBT	3 (9.8)
CC050VNRBT	5 (16.4)
CC070VNRBT	7 (23)
CC100VNRBT	10 (32.8)
CC150VNRBT	15 (49.2)

Pin assignments of cable for motor connectors

Pin No.	Color	Lead size
1	Red	AWG17 (1.25 mm ²)
2	White	
3	Black	
4	Green/yellow	

• Motor side

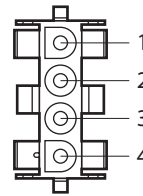

Model: 350780-1
(TE Connectivity)

• Driver side

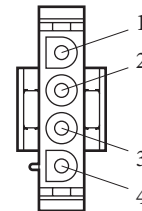

Model: 350779-1
(TE Connectivity)

Pin assignments of cable for encoder connectors

Pin No.	Color	Lead size
1	Green	AWG19 (0.75 mm ²)
2	Black	
3	Red	AWG25 (0.2 mm ²)
4	White	AWG19 (0.75 mm ²)
5	Yellow	AWG25 (0.2 mm ²)
6	Brown	

• Motor side

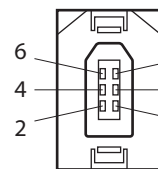

Model: 54280-0609
(Molex Incorporated)

• Driver side

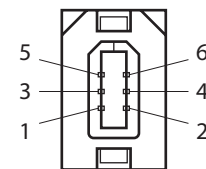

Model: 55100-0670
(Molex Incorporated)

Pin assignments of cable for electromagnetic brake connectors

Pin No.	Color	Lead size
1	White	AWG21 (0.5 mm ²)
2	Black	

• Motor side

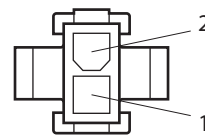

Model: 5559-02P-210
(Molex Incorporated)

• Driver side

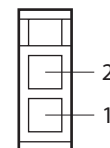

Model: 5557-02R-210
(Molex Incorporated)

1-2 Communication cable for the support software

Be sure to purchase the communication cable for the support software when connecting a driver and PC in which the support software **MEXE02** has been installed.

This is a set of a PC interface cable and USB cable. The cable is connected to the USB port on the PC.

The **MEXE02** can be downloaded from Oriental Motor Website Download Page.

Model: **CC05IF-USB** [5 m (16.4 ft.)]

1-3 Driver cables

These are shielded cables for driver I/O signals offering excellent noise resistance. There are two types of cables, one for I/O signals (for CN7) and the other for analog I/O signals (for CN6).

Application	Model	Length [m (ft.)]
For CN7 (36 pins)	CC36D1E	1 (3.3)
	CC36D2E	2 (6.6)
For CN6 (20 pins)	CC20D1E	1 (3.3)
	CC20D2E	2 (6.6)

2 Accessories

2-1 Wiring support tools

■ Accessory sets

Use accessory sets when the analog I/O functions are used.
 This is a set of one CN6 connector and two variable resistors.
 Model: **AS-SV2**
 This is a CN6 connector.
 Model: **AS-SD1**

■ Regeneration resistors

Connect the regeneration resistor if gravitational operation or other operations involving up/down movement, or sudden starting/stopping of a large inertial load, will be repeated frequently.

Model	Applicable product
RGB100	NXD20-A, NXD20-C
RGB200	NXD75-S

■ Connector-terminal block conversion units

These are conversion units that can connect the driver to a programmable controller via the terminal block.

Applicable connector	Model	Type	Length [m (ft.)]
CN6	CC20T10E	Single-row	1 (3.3)
CN7	CC36T10E		
CN6	CC20WT05AE	Two-rows	0.5 (1.6)
	CC20WT10AE		1 (3.3)
CN7	CC36WT05AE		0.5 (1.6)
	CC36WT10AE		1 (3.3)

2-2 Setting tool

■ Data setter

The data setter lets you set parameters for your **NX** Series with ease and also functions as a monitor.
 Model: **OPX-2A**

2-3 Other accessory

■ Battery

This is a battery needed when the absolute function is used in the position control mode.
 Model: **BAT01A**

11 References

◆ Table of contents

1	Timing charts.....	222
2	Speed - Torque Characteristics.....	236
	2-1 Standard type	236
	2-2 PS geared type	237
	2-3 PJ geared type.....	239
3	Function/parameter list (position control mode)	242
4	Function/parameter list (speed control mode)	250
5	Function/parameter list (torque control mode)	258
6	Function/parameter list (tension control mode).....	262
7	Alarm list	268
8	Warnings list.....	272



1 Timing charts

■ **Power supply input [position control mode, speed control mode (servo locked after stopping)]**

- When no 24 VDC power supply is used

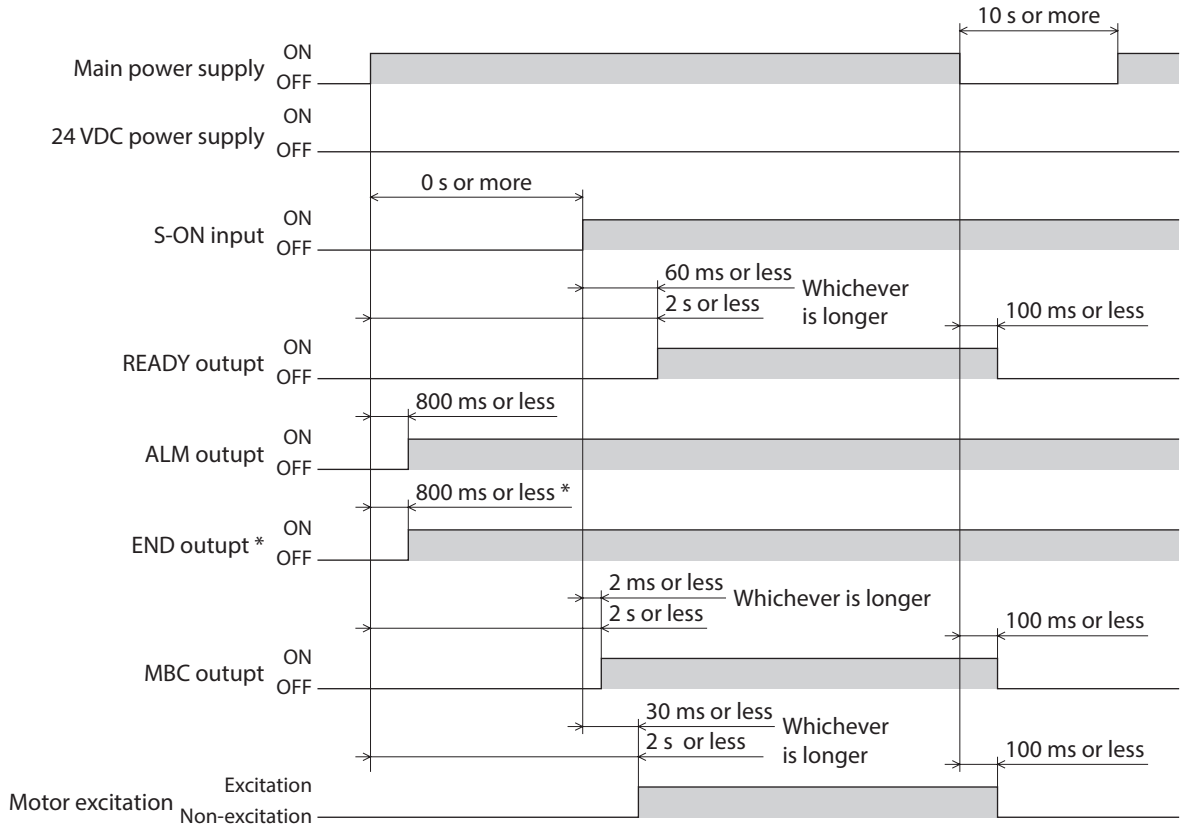

● When a 24 VDC power supply is used

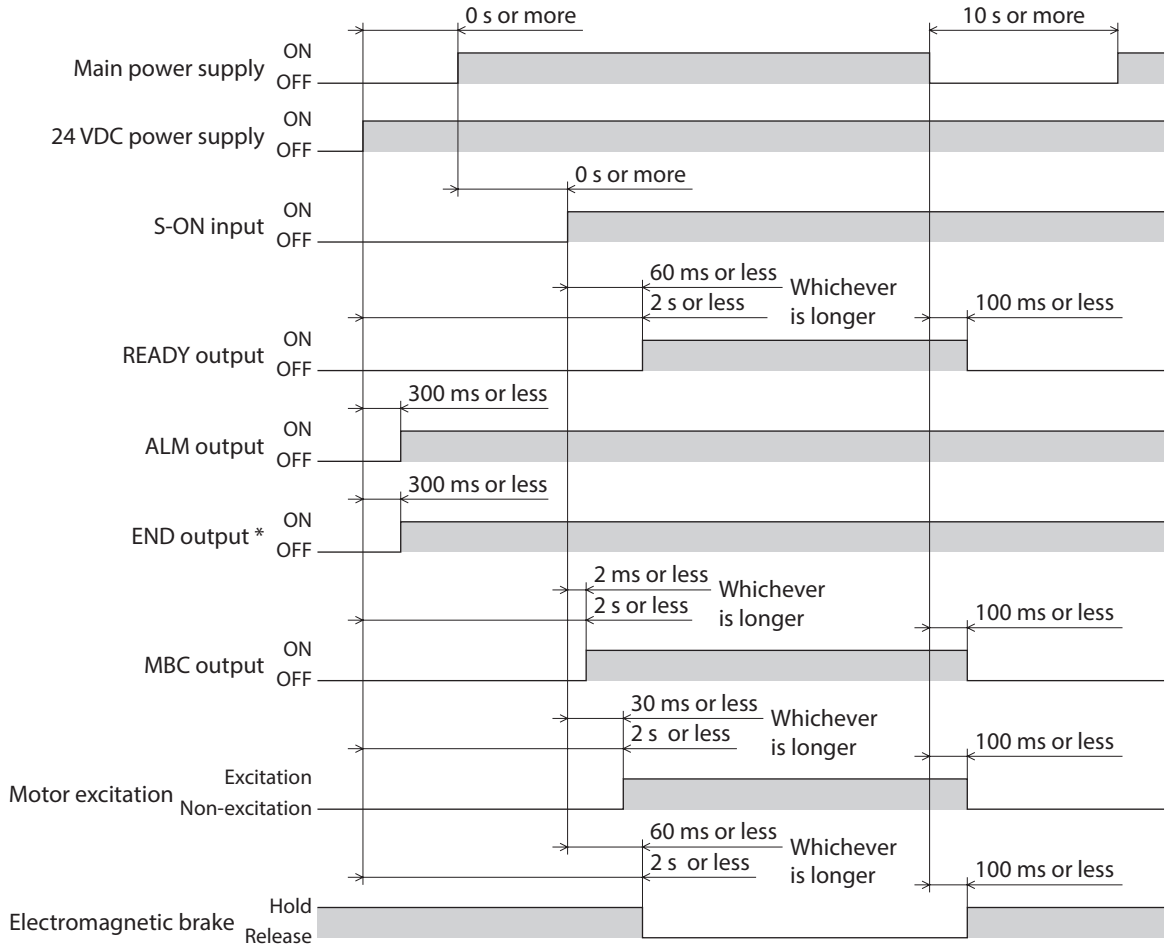

* Position control mode only.

- When to turn on the main power and 24 VDC power is not specified.

■ Power supply input [speed control mode (free after stopping), torque control mode, tension control mode]

● When no 24 VDC power supply is used

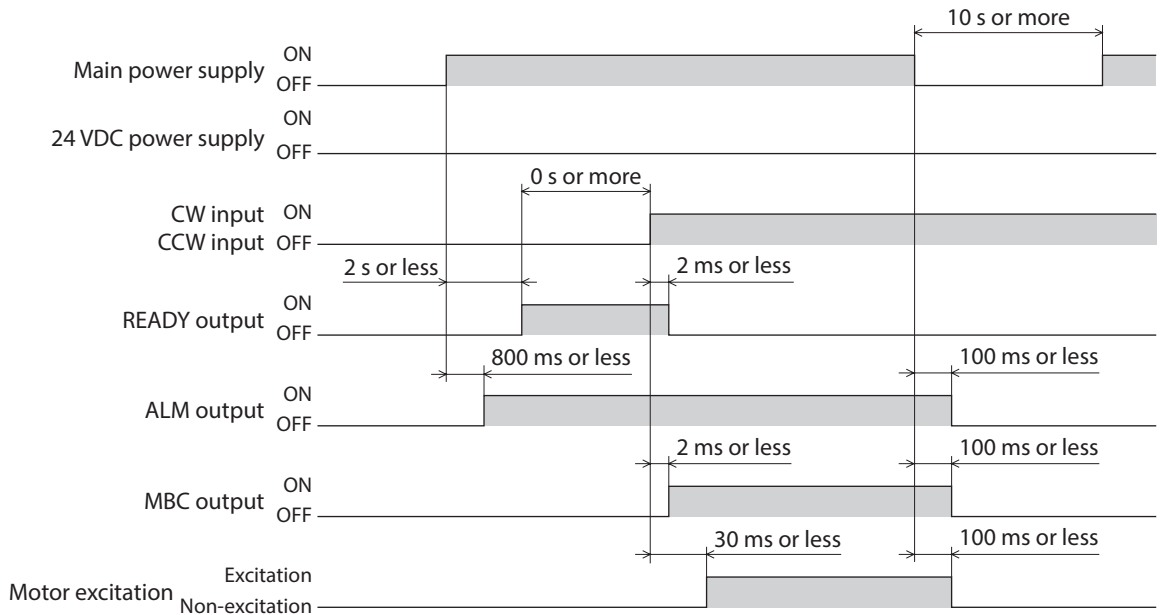

● When a 24 VDC power supply is used

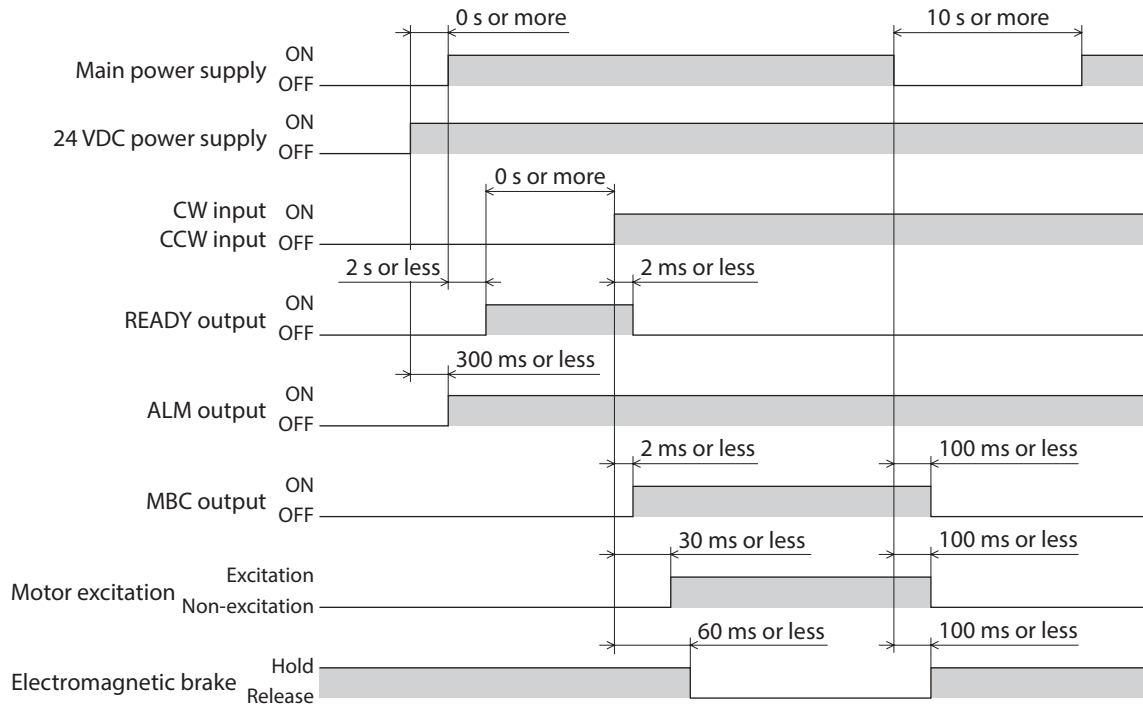

- When to turn on the main power and 24 VDC power is not specified.

■ S-ON input [position control mode, speed control mode (servo locked after stopping)]

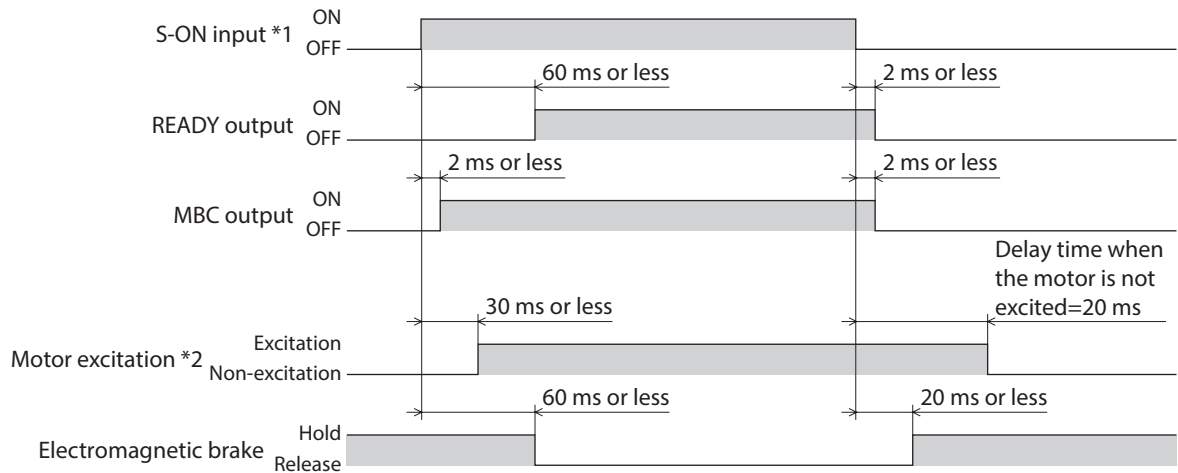

*1 When the S-ON input is OFF, the motor will put into a non-excitation state after the electromagnetic brake is actuated.

*2 The electromagnetic brake does not operate if no 24 VDC power is input.

■ CW input/CCW input [speed control mode]

● Free after stopping

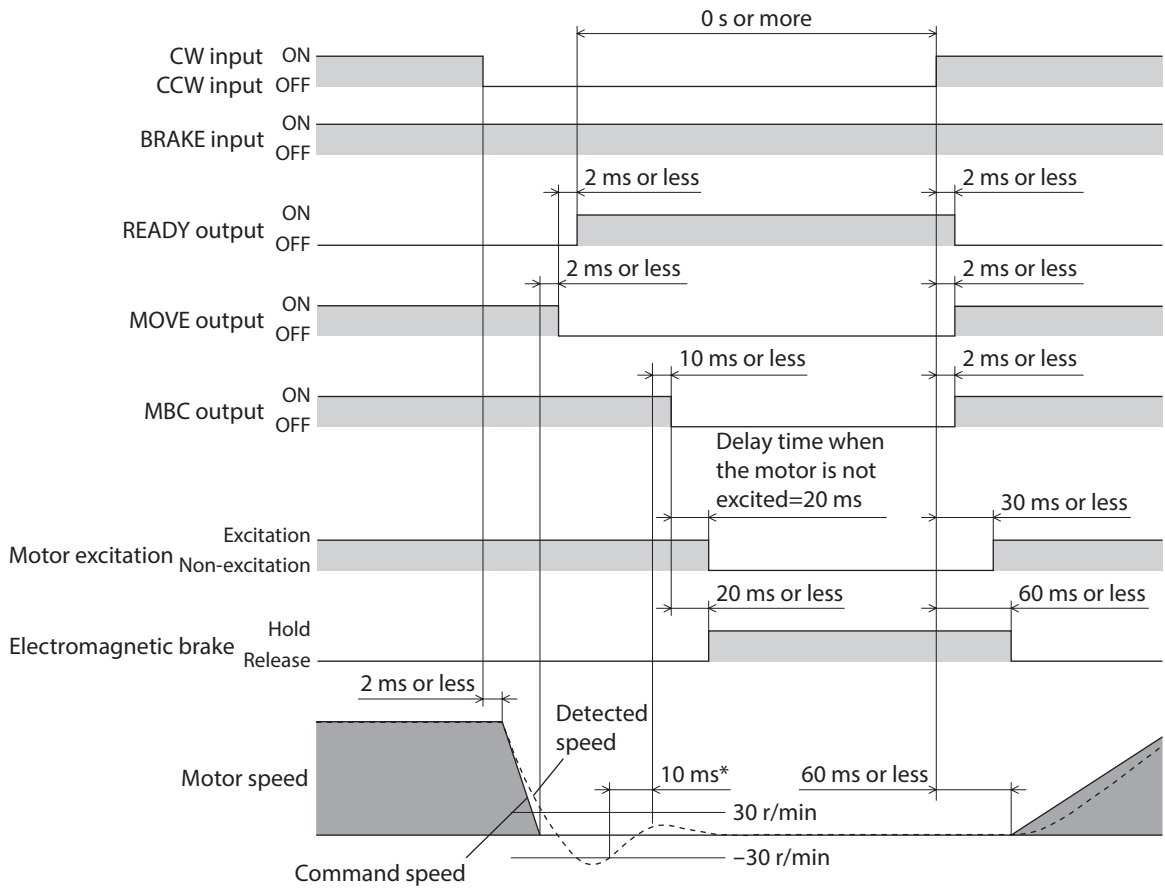

* If the detected speed remains at or below ± 30 r/min for 10 ms or more, the MBC output will turn OFF.

● Servo locked after stopping

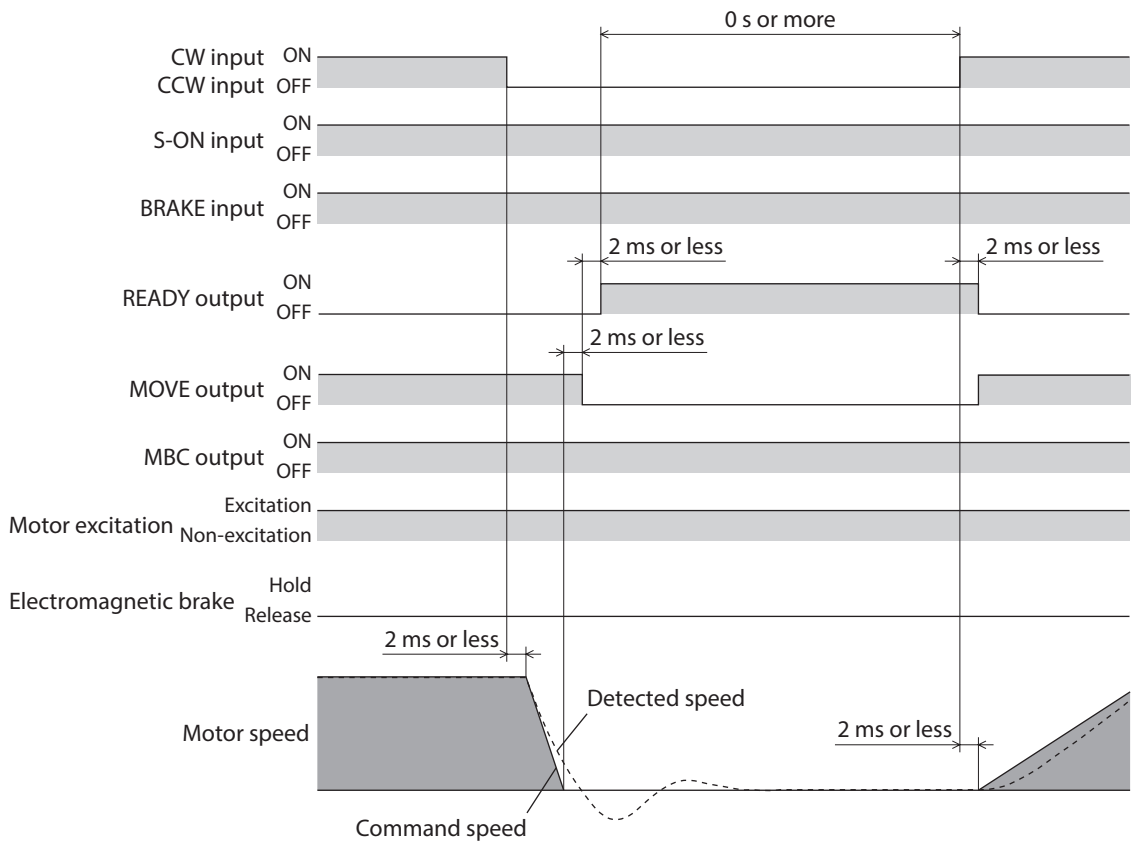

■ CW input/CCW input [torque control mode, tension control mode]

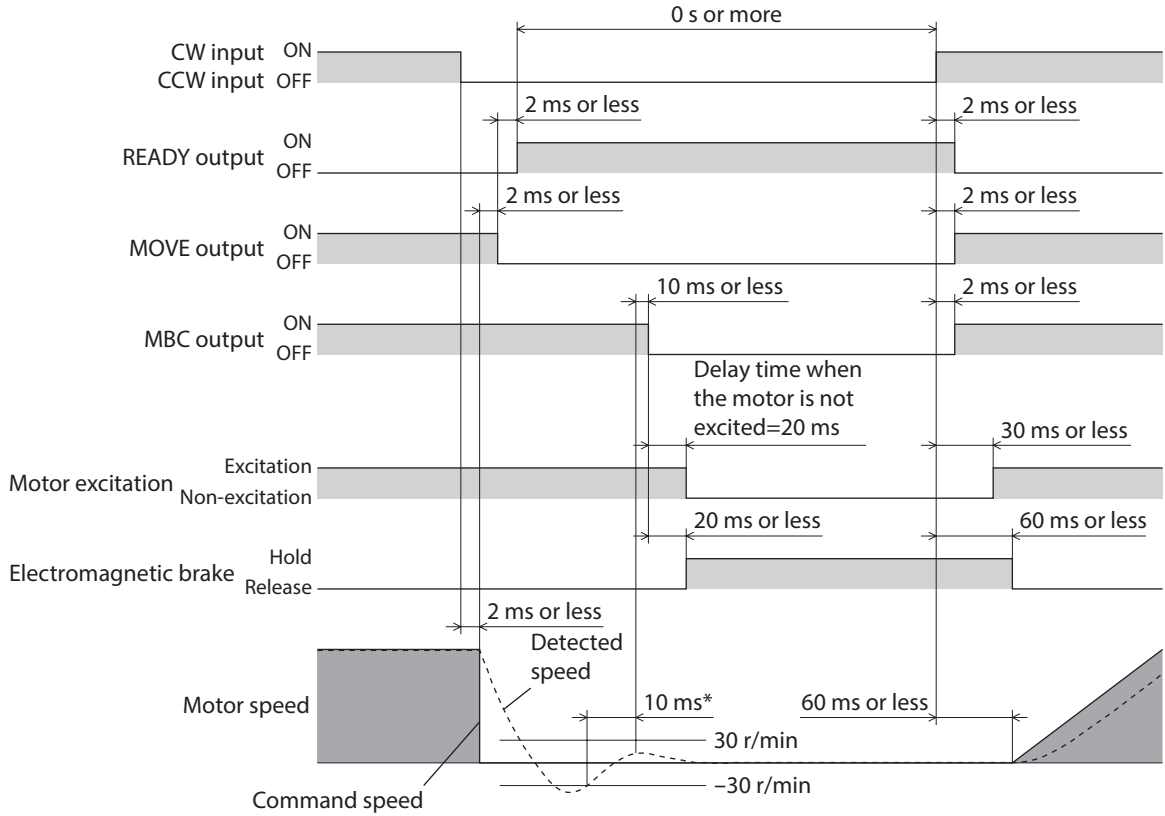

* If the detected speed remains at or below ± 30 r/min for 10 ms or more, the MBC output will turn OFF.

■ FREE input

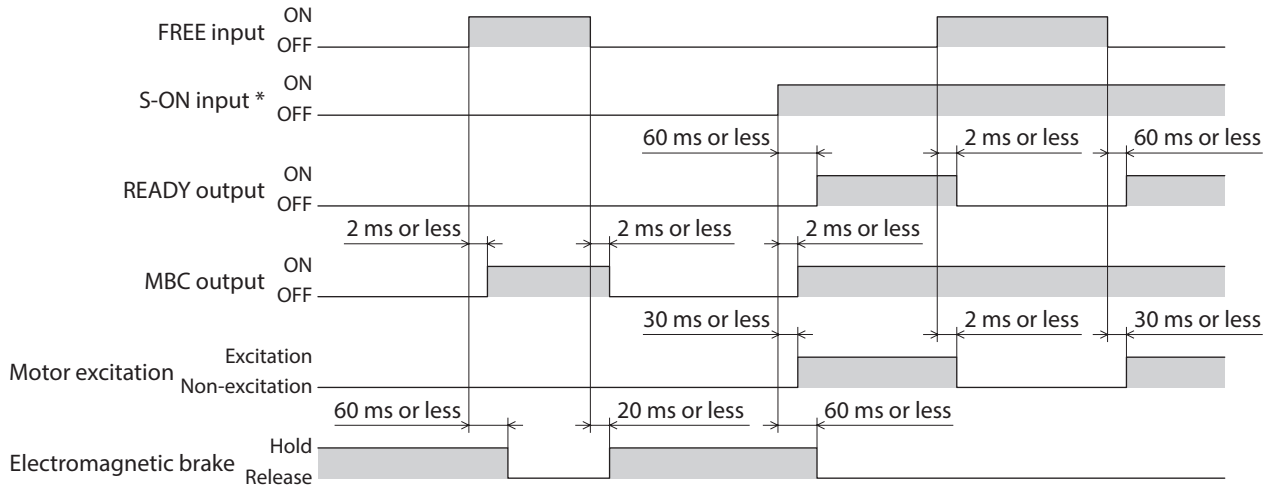

* Position control mode and speed control mode only.

■ P-PRESET input [position control mode]

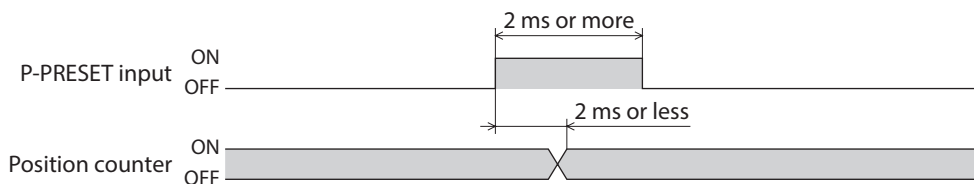

■ CLR input [position control mode]

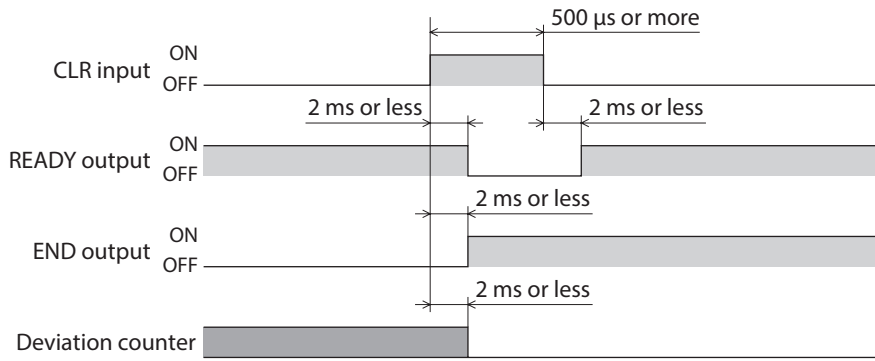

■ ALM-RST input

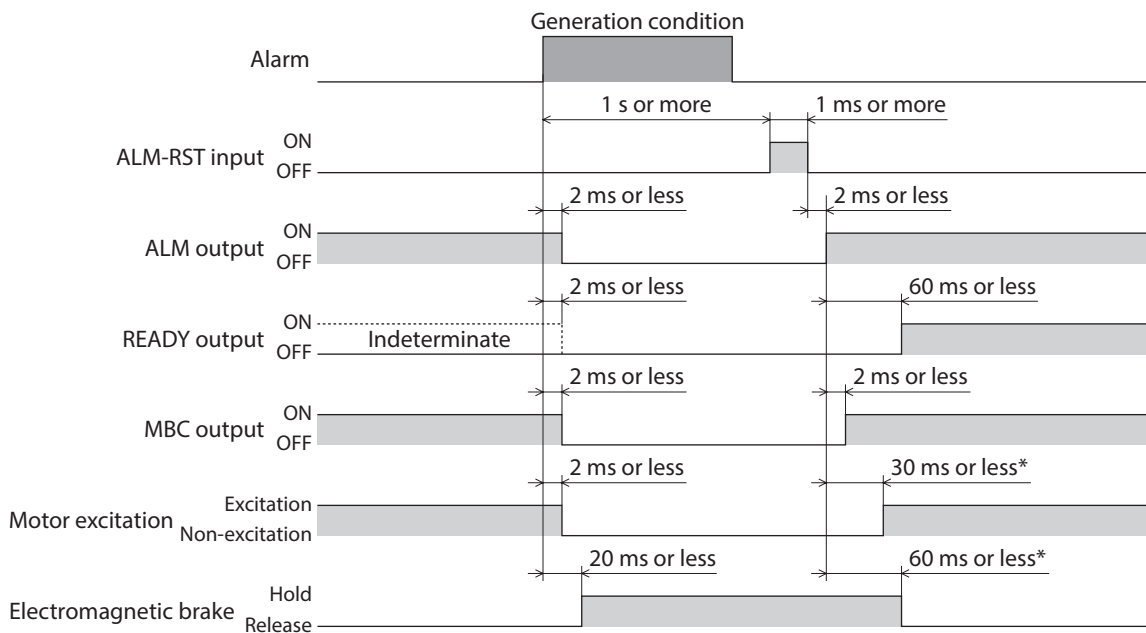

* In the position control mode or speed control mode (servo locked upon stopping) when the S-ON input is ON. In the torque control mode and tension control mode, the motor will remain unexcited and the electromagnetic brake will continue to hold the load in position until a start signal is input.

- This is the timing chart when an alarm to put the motor into a non-excitation state is generated.

■ BRAKE input [speed control mode]

● Free after stopping

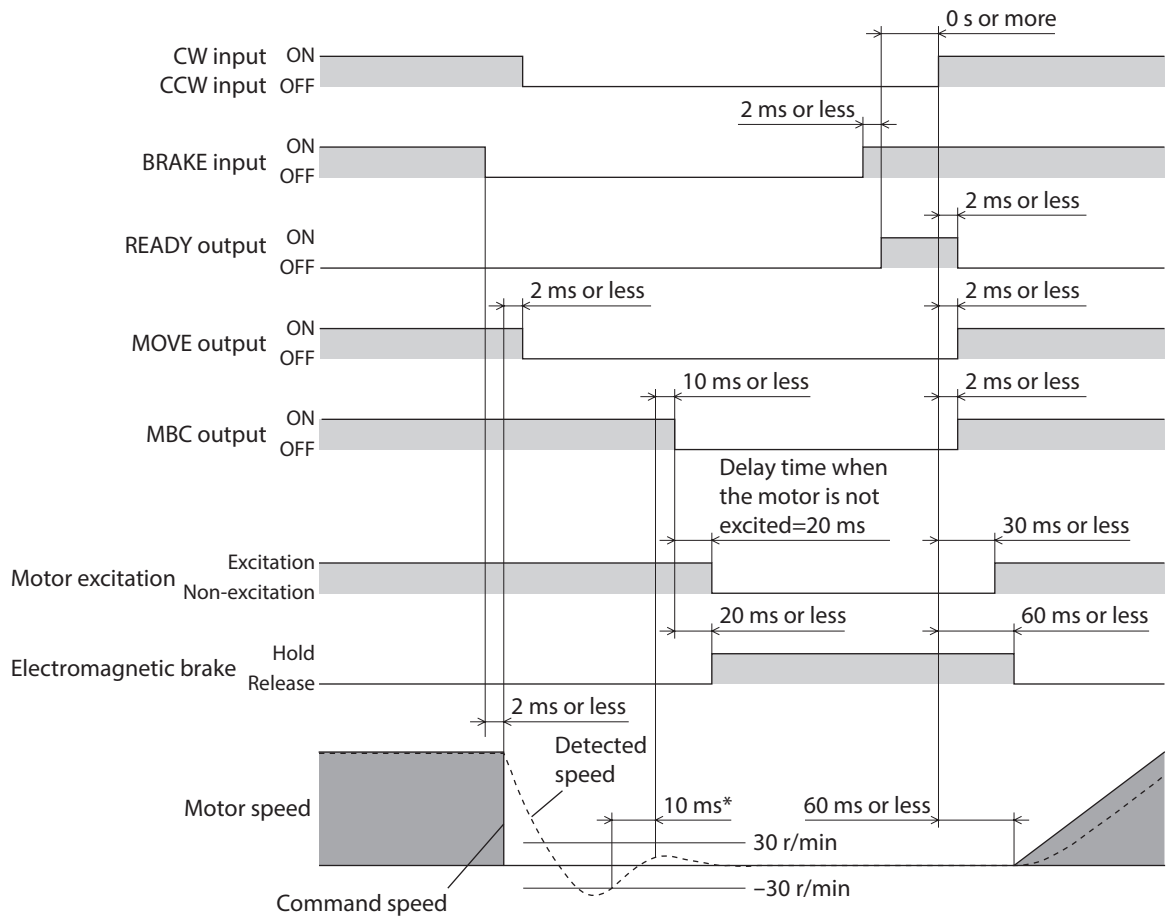

* If the detected speed remains at or below ± 30 r/min for 10 ms or more, the MBC output will turn OFF.

● Servo locked after stopping

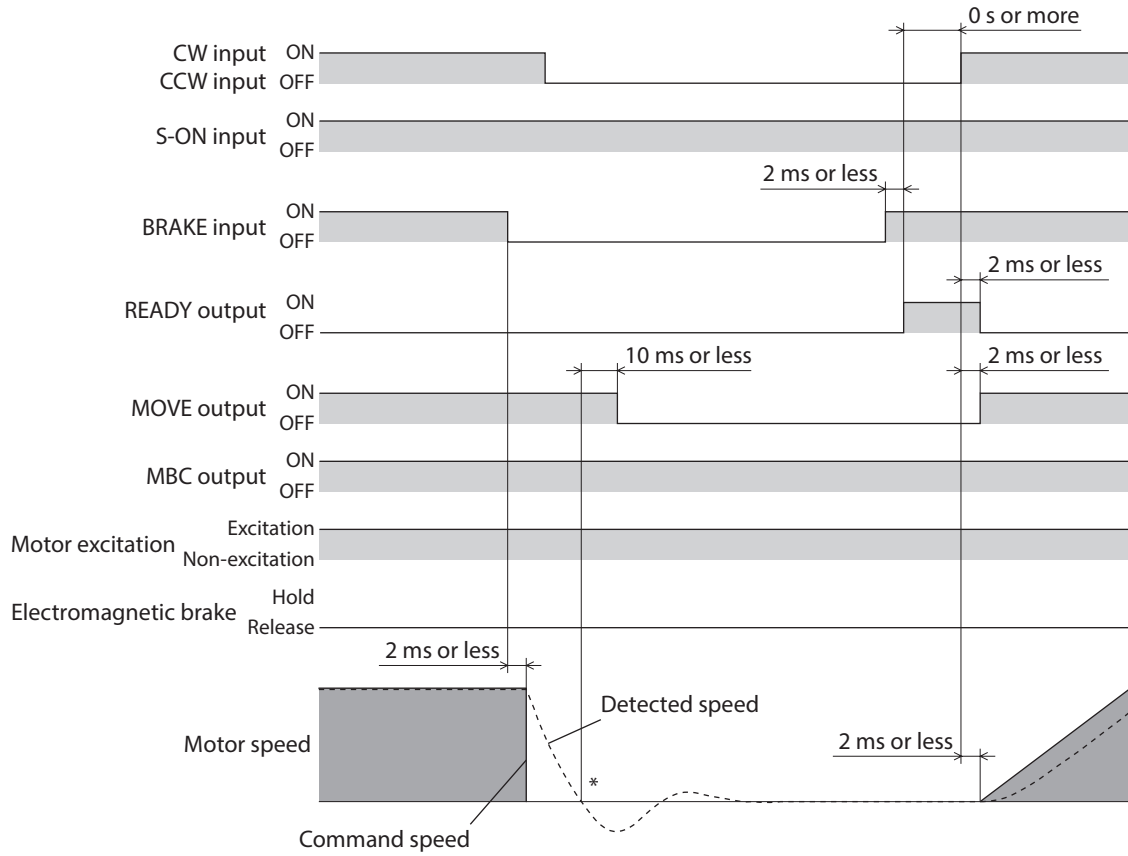

* The MOVE output will turn OFF when the detected speed becomes zero.

■ W-RST input [tension control mode]

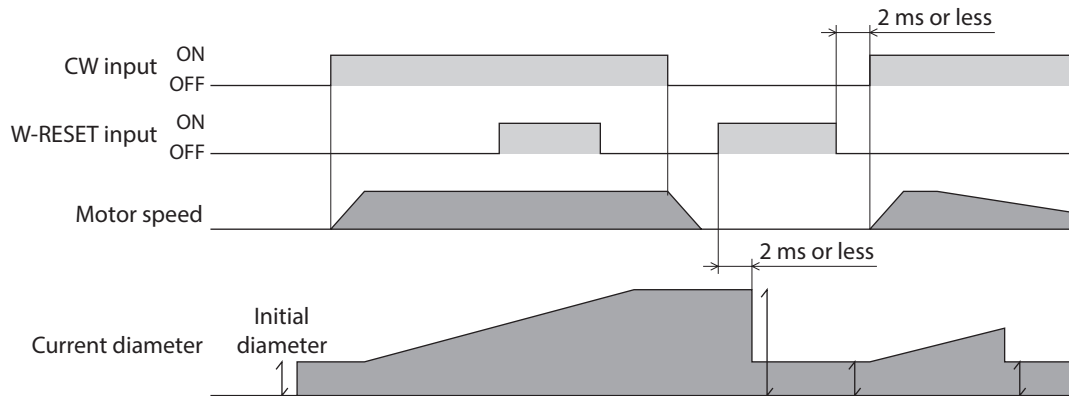

■ **TL input [position control mode, speed control mode]**

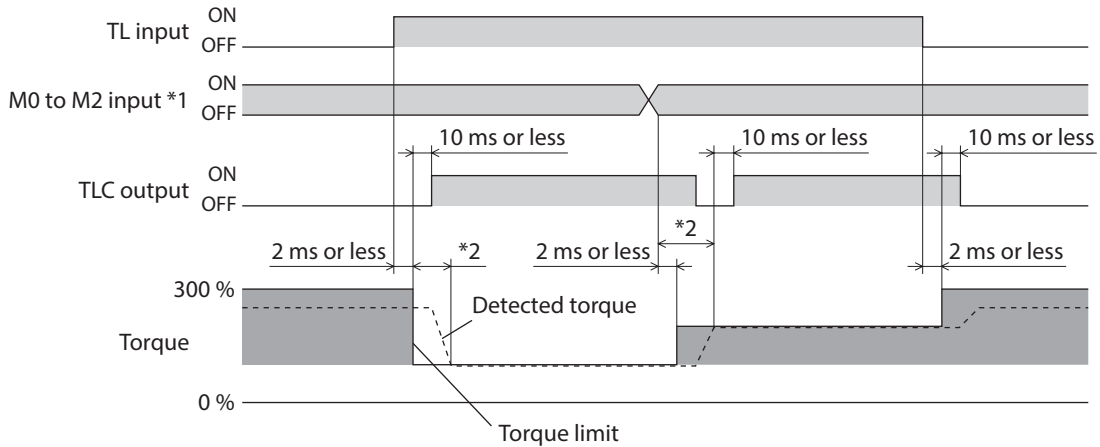

*1 In the position control mode, the M0 and M1 inputs are used instead.
 *2 The specific time varies depending on the load condition and gain.

■ **END output/NEAR output [position control mode]**

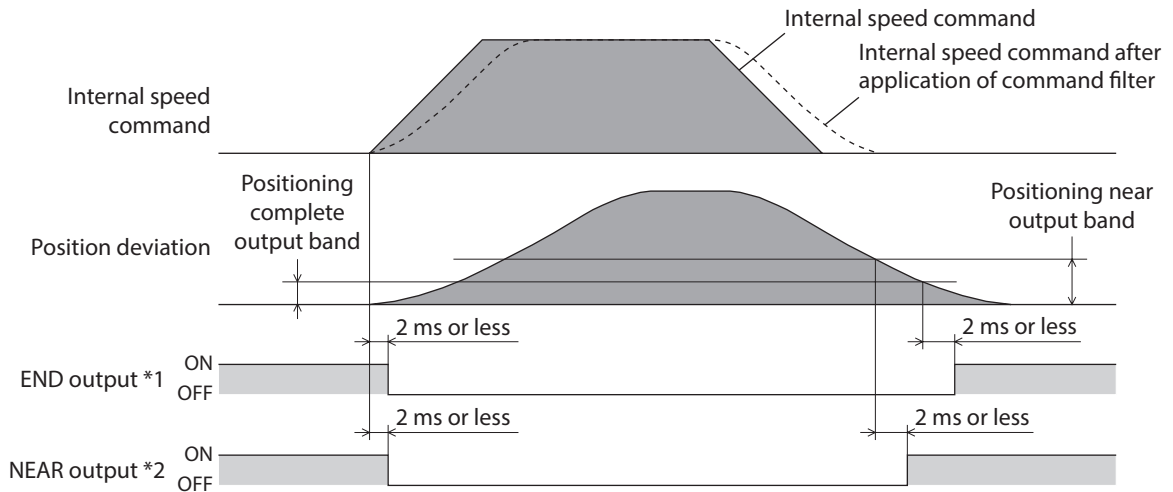

*1 The END output will turn ON when the internal speed command becomes "0" while the position deviation remains within the range set in the application parameter for positioning complete output band.
 *2 The NEAR output will turn ON when the internal speed command becomes "0" while the position deviation remains within the range set in the application parameter for positioning near output band.

■ **VLC output [torque control mode, tension control mode]**

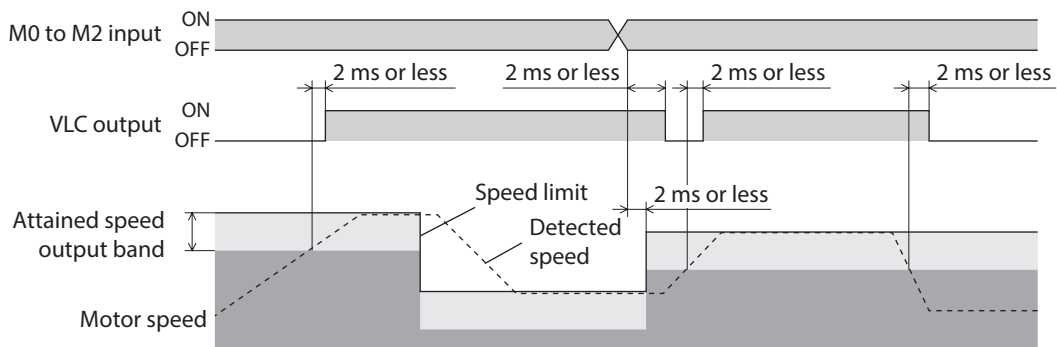

■ **ZV output [speed control mode, torque control mode, tension control mode]**

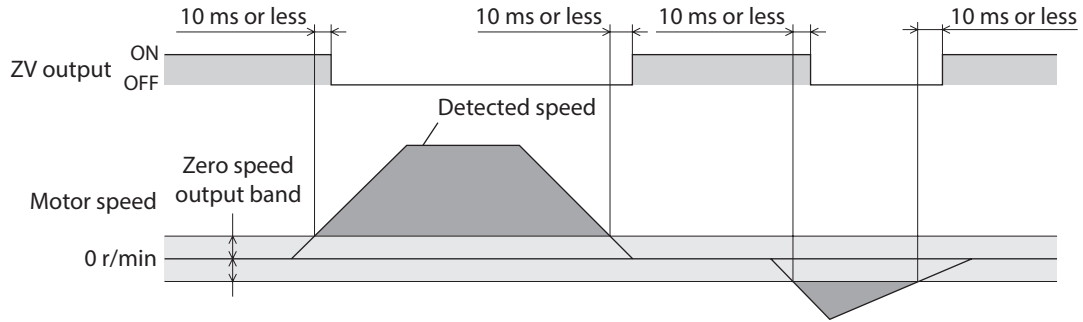

■ **VA output [speed control mode]**

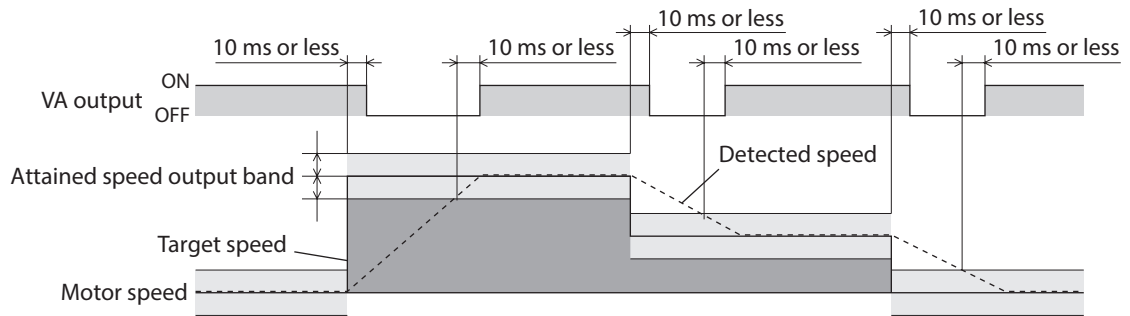

■ **ALM output/WNG output**

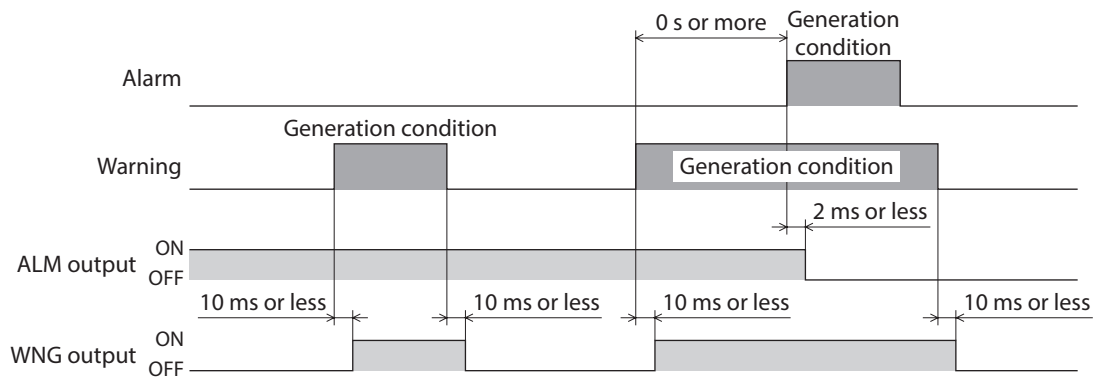

* Some alarms are not preceded by a warning.

■ **WNG output**

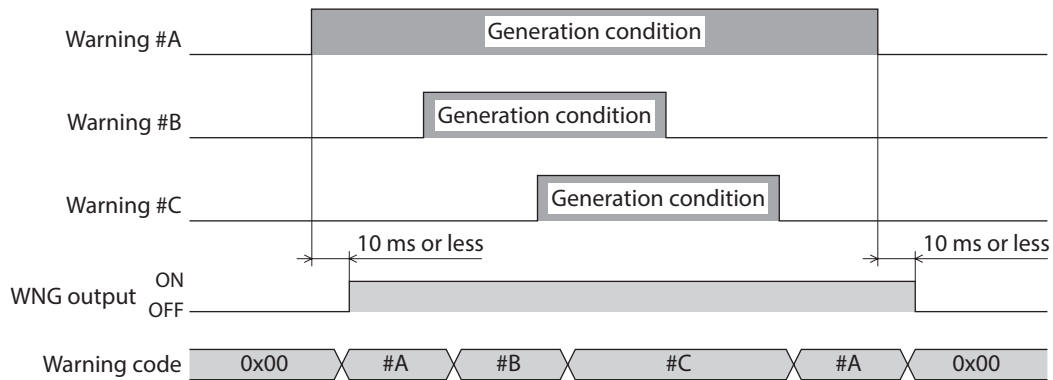

■ Operation based on pulse input [position control mode]

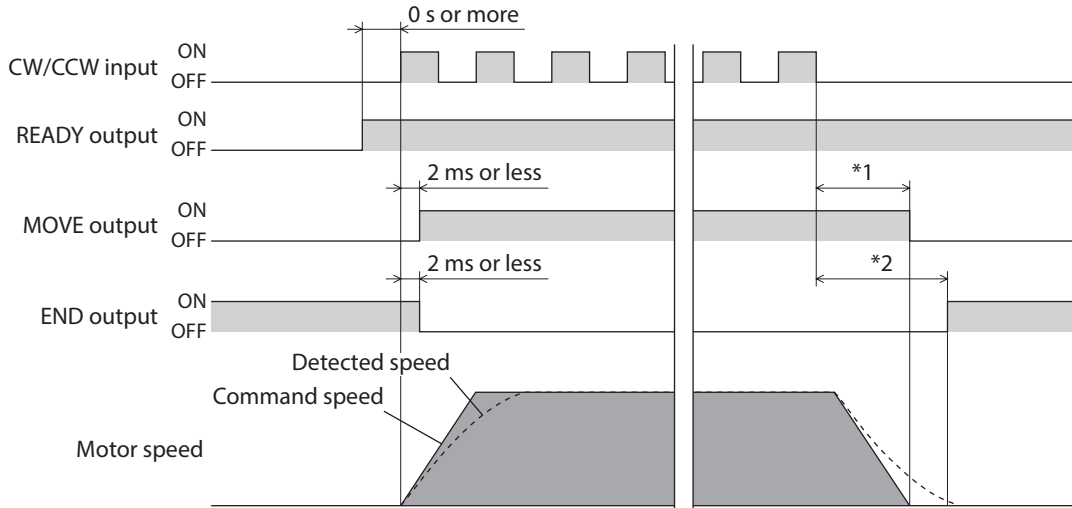

*1 The specific time varies depending on the setting of the application parameter for command filter.
 *2 The specific time varies depending on the gain, positioning complete band and load condition.

■ Output selection

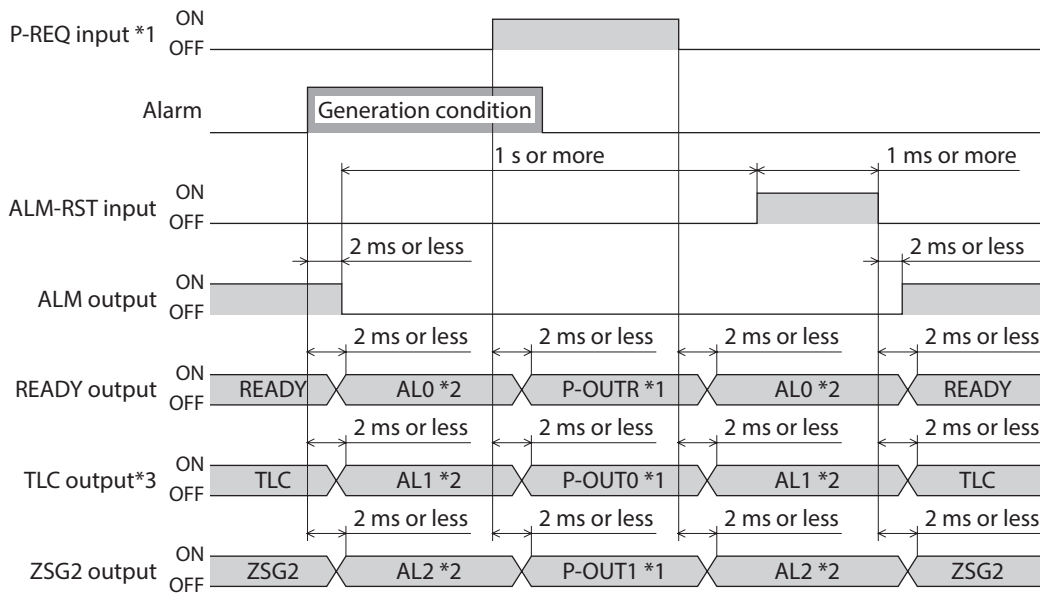

*1 In the position control mode.
 *2 When the application parameter for alarm code output is set to "1: Enable."
 *3 In the position control mode or speed control mode. The VLC output becomes effective in the torque control mode and tension control mode.

■ **Current position output [position control mode]**

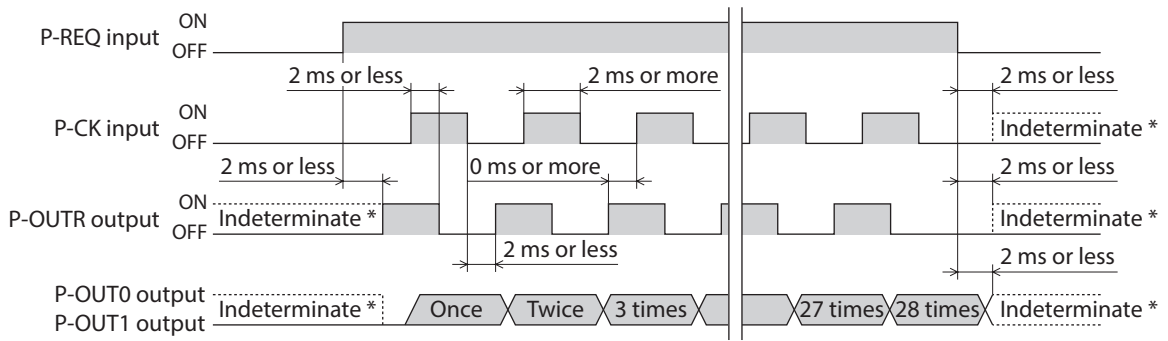

■ **Multi-stage command operation [speed control mode, torque control mode]**

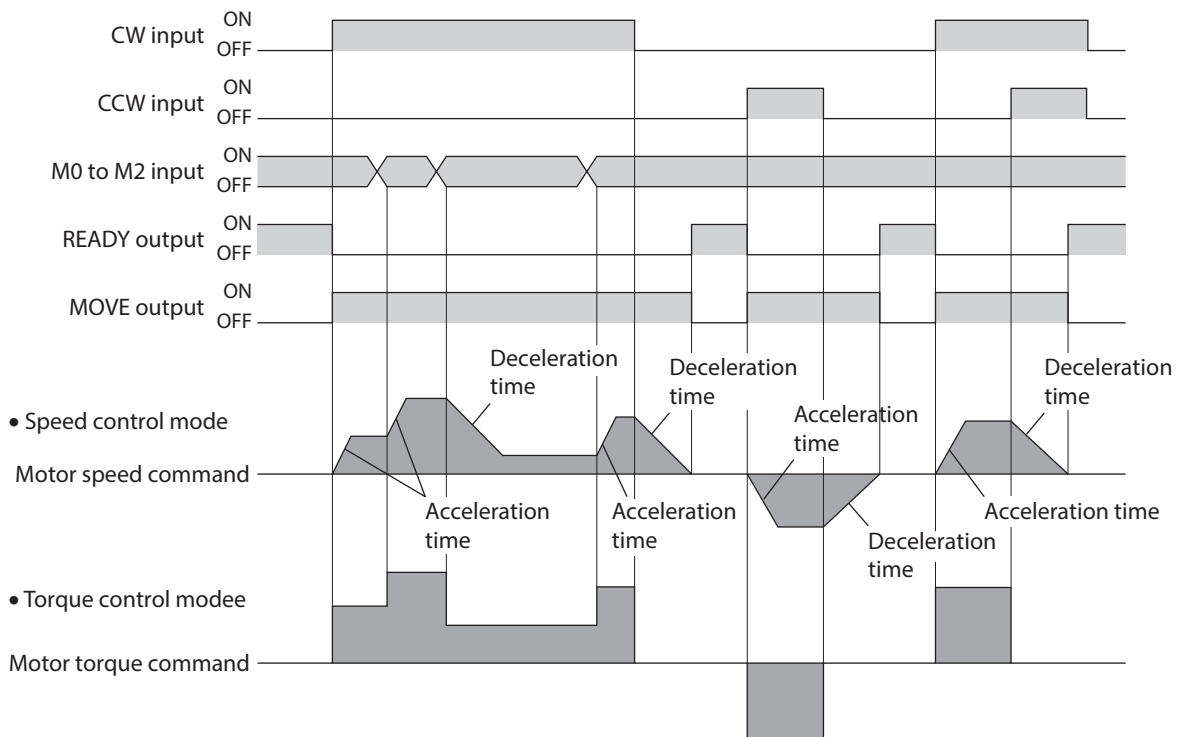

■ **M0 to M1 input [position control mode]**

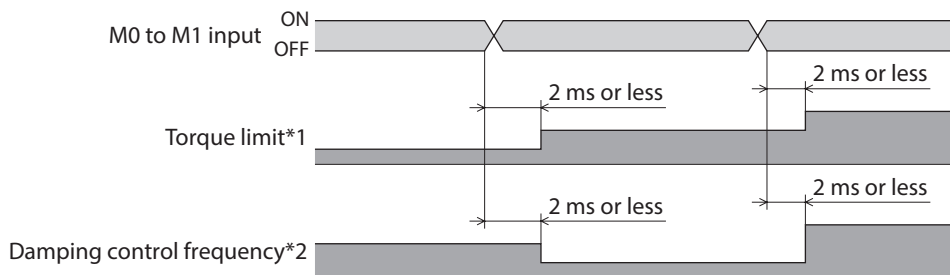

*1 The TL input is ON.

*2 Damping control is enabled.

■ M0 to M2 input [speed control mode]

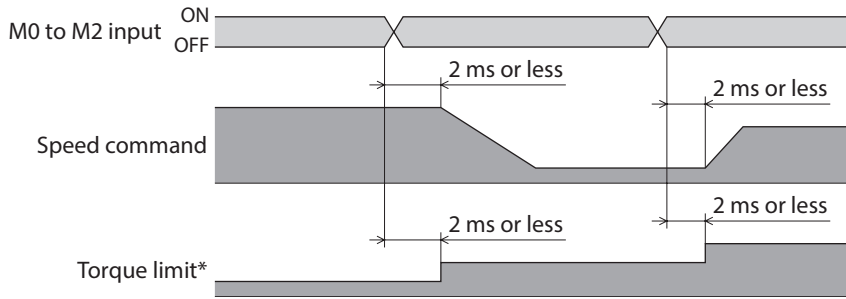

* The TL input is ON.

■ M0 to M2 input [torque control mode]

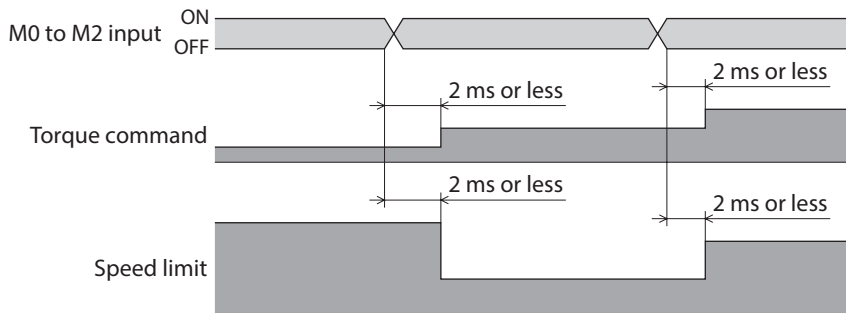

■ Tension controlled operation

● Winding operation (CW input ON)

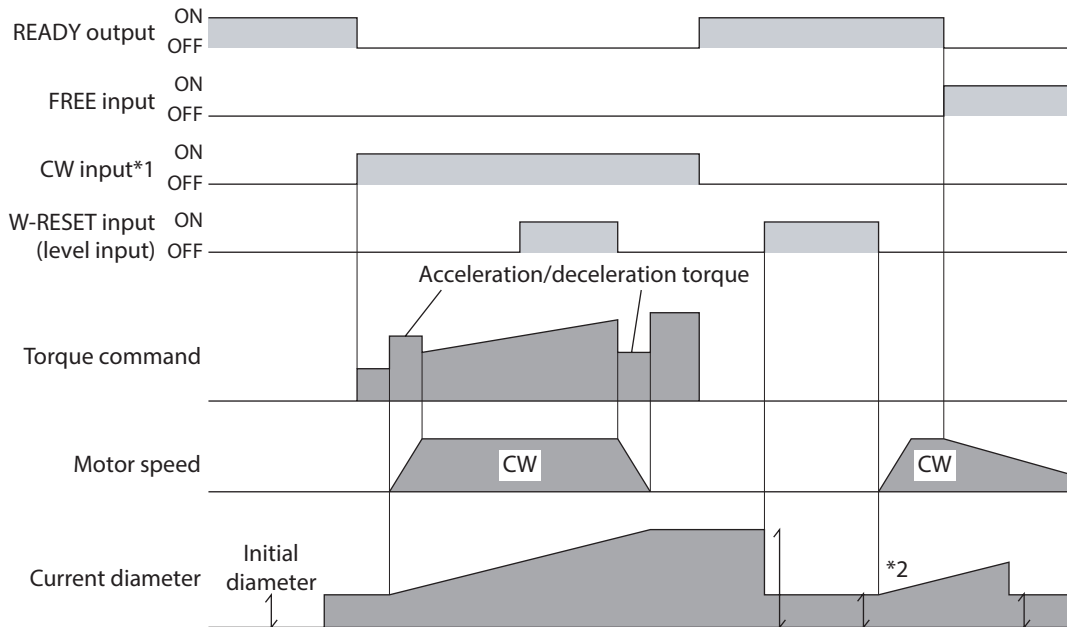

*1 In high function mode I and high function mode II, the CCW input is disabled.

*2 Even when the CW input is OFF and FREE input is ON, the driver will continue to calculate the current diameter if the motor is rotated externally.

● Unwinding operation (CW input ON)

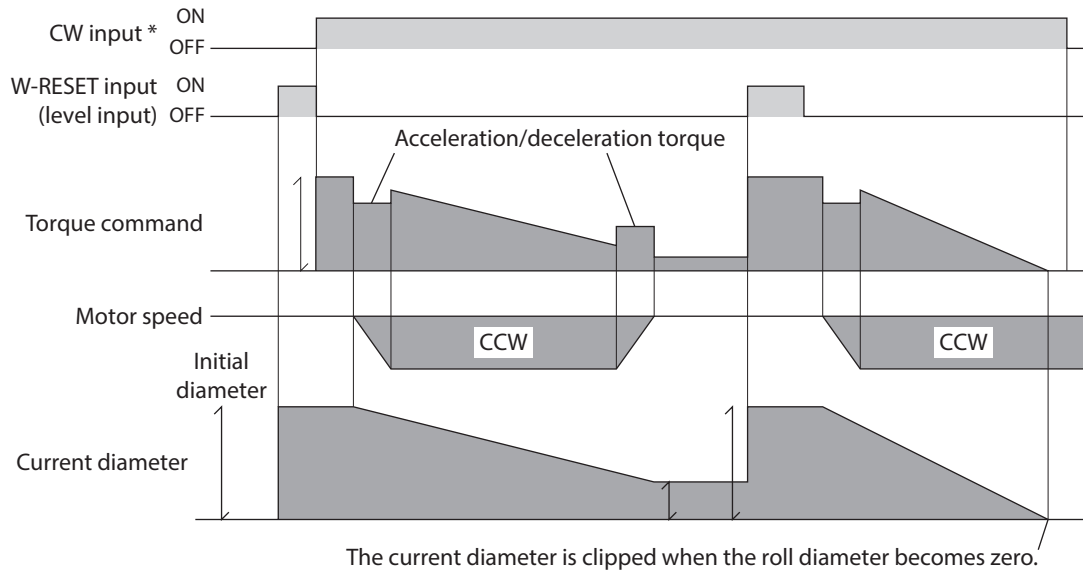

* In high function mode I and high function mode II, the CCW input is disabled.

2 Speed - Torque Characteristics

Continuous duty region (Continuous): This refers to the region where a motor can be operated at the continuous ratings.

Limited duty region (Intermittent): This refers to the region which can be used for a short period of time such as acceleration or deceleration.

Type	Motor model	Continuous stall current [A]	Heat sink size [mm (in.)]	Maximum speed [r/min]
Standard	NXM45A, NXM45M	0.91	250×250×6 (9.84×9.84×0.24)	5,500
	NXM410A, NXM410M	1.12		
	NXM620A, NXM620M	1.8		
	NXM640A, NXM640M	3.2	300×300×10 (11.81×11.81×0.39)	
	NXM975A, NXM975M	5.9	350×350×10 (13.78×13.78×0.39)	
Geared	NXM45A, NXM45M	0.91	250×250×6 (9.84×9.84×0.24)	3,000
	NXM410A, NXM410M	1.12		
	NXM610A-J, NXM610M-J	1.1		
	NXM620A-J, NXM620M-J NXM620A, NXM620M	1.8		
	NXM640A, NXM640M	3.2	300×300×10 (11.81×11.81×0.39)	
	NXM940A-J, NXM940M-J	5.1		
	NXM975A-J, NXM975M-J	5.9	350×350×10 (13.78×13.78×0.39)	

2-1 Standard type

NXM45A, NXM45M

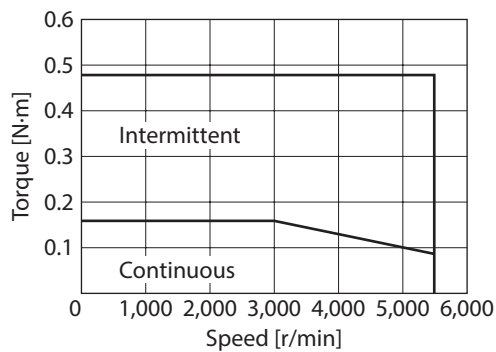

NXM410A, NXM410M

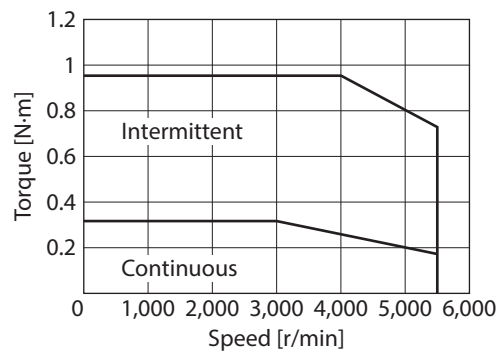

NXM620A, NXM620M

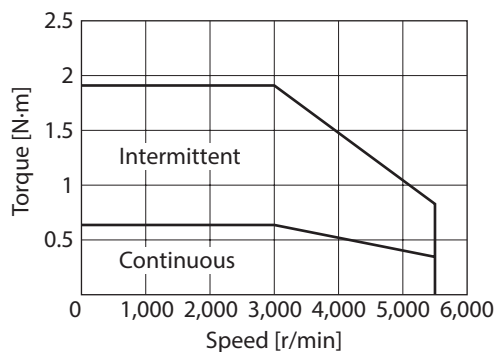

NXM640A, NXM640M

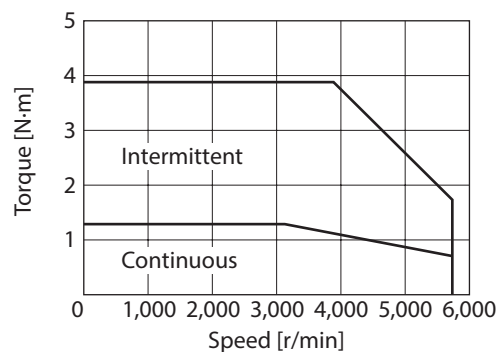

NXM975A, NXM975M

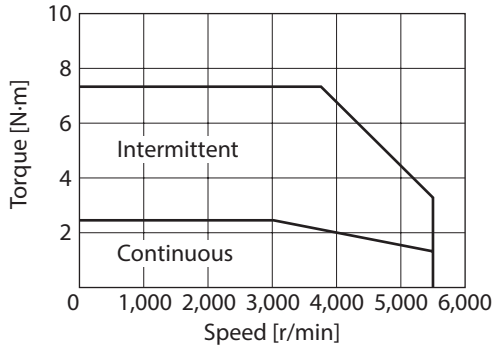

2-2 PS geared type

● **NX65**

Gear ratio: 5

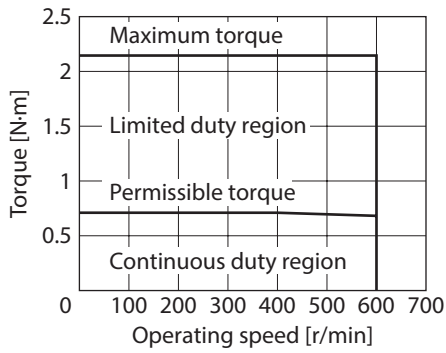

Gear ratio: 10

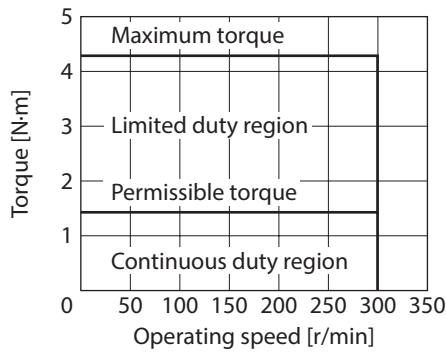

"Speed - Torque Characteristics" for the motor of the **NX65 PS** geared type (Motor model: NXM45A/NXM45M)

Gear ratio: 25

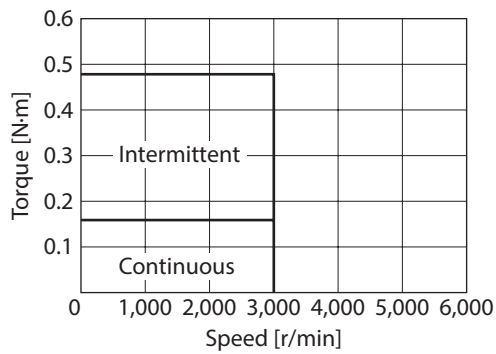
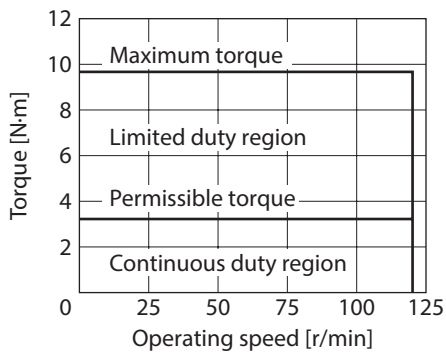

● **NX610**

Gear ratio: 5

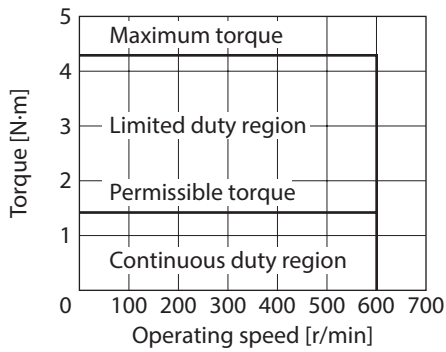

Gear ratio: 10

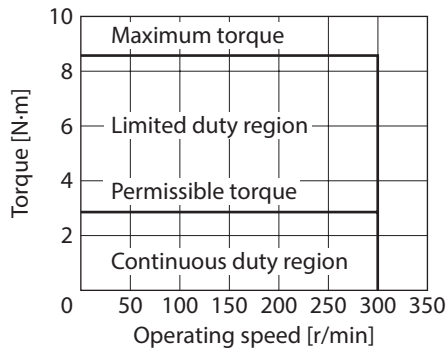

“Speed - Torque Characteristics” for the motor of the **NX610 PS** geared type (Motor model: NXM410A/NXM410M)

Gear ratio: 25

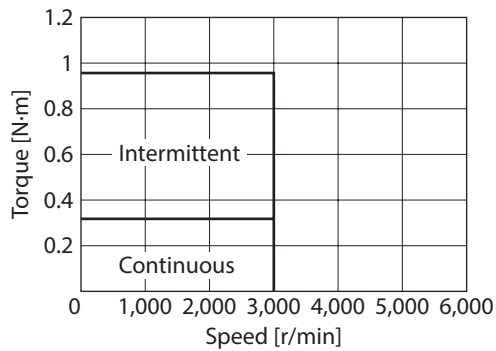
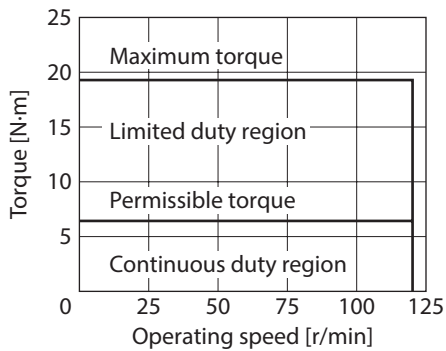

● **NX920**

Gear ratio: 5

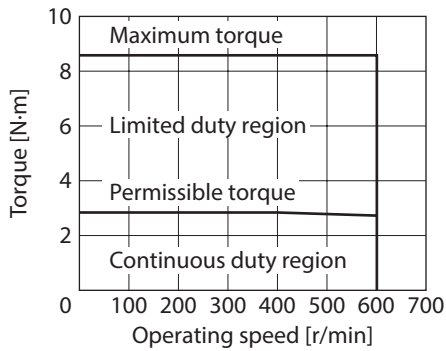

Gear ratio: 10

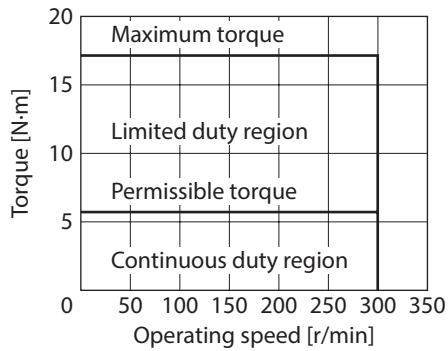

“Speed - Torque Characteristics” for the motor of the **NX920 PS** geared type (Motor model: NXM620A/NXM620M)

Gear ratio: 25

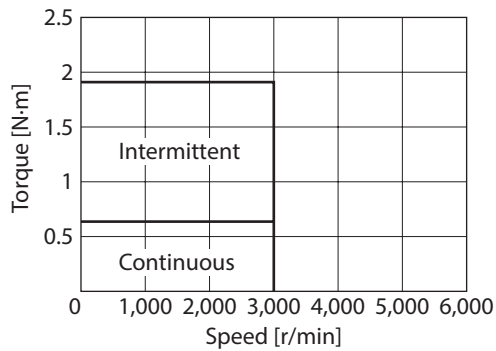
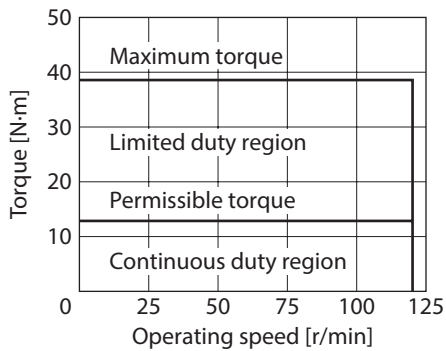

● **NX940**

Gear ratio: 5

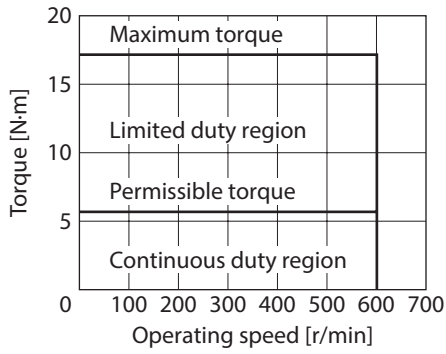

Gear ratio: 10

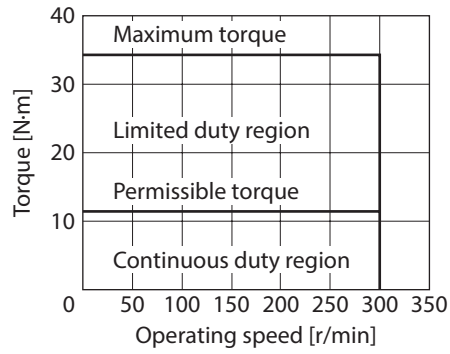

Gear ratio: 25

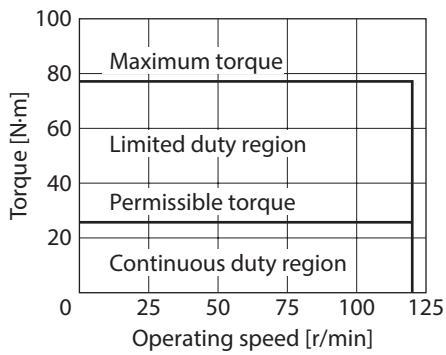

“Speed - Torque Characteristics” for the motor of the **NX940 PS** geared type
(Motor model: NXM640A/NXM640M)

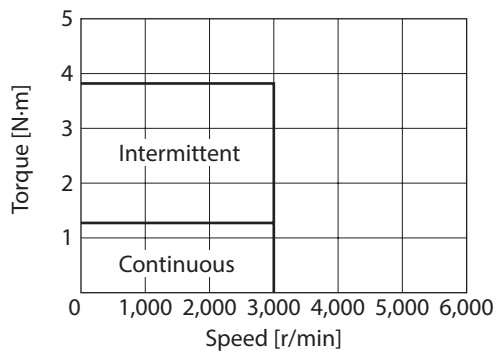

2-3 PJ geared type

● **NX810**

Gear ratio: 5

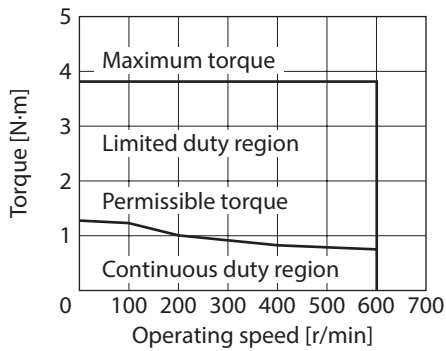

Gear ratio: 10

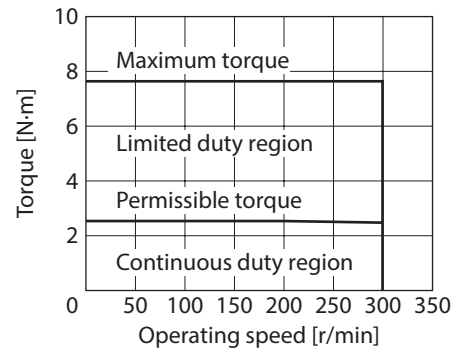

● **NX810**

Gear ratio: 25

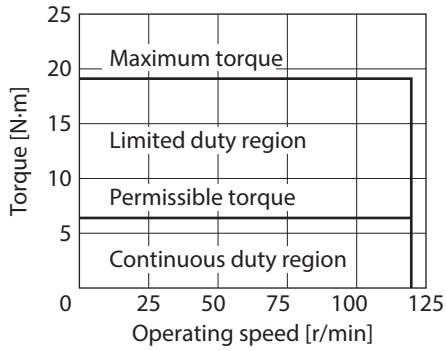

"Speed - Torque Characteristics" for the motor of the **NX810 PJ** geared type (Motor model: NXM610A-J/NXM610M-J)

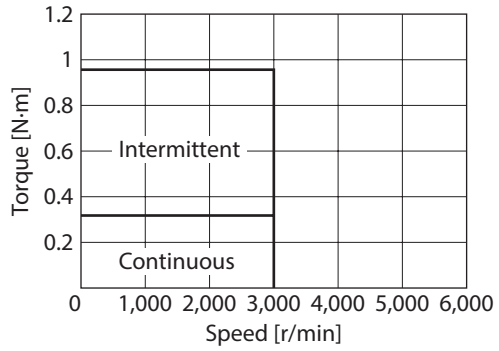

● **NX820**

Gear ratio: 5

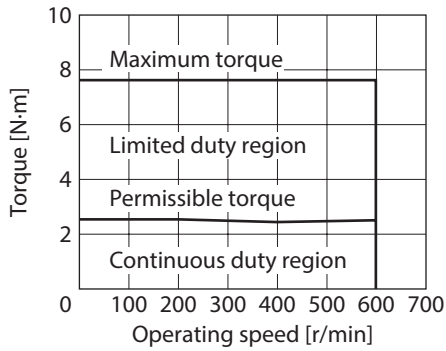

Gear ratio: 10

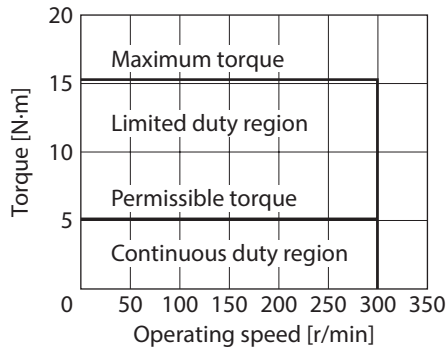

"Speed - Torque Characteristics" for the motor of the **NX820 PJ** geared type (Motor model: NXM620A-J/NXM620M-J)

Gear ratio: 25

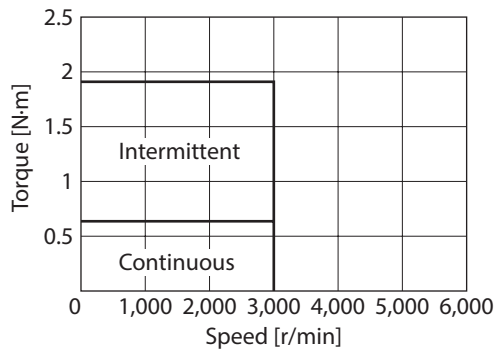
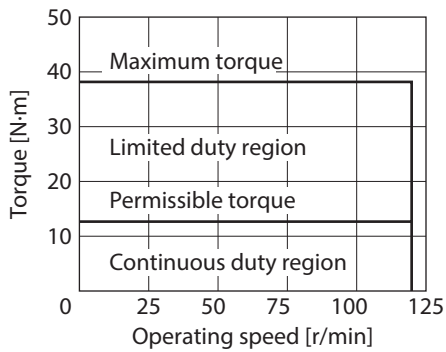

● **NX1040**

Gear ratio: 5

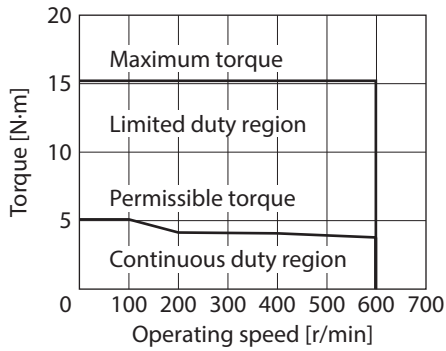

Gear ratio: 10

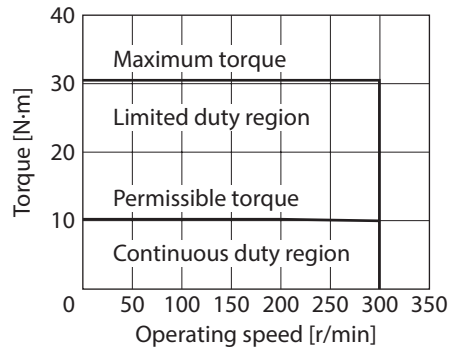

“Speed - Torque Characteristics” for the motor of the **NX1040 PJ** geared type
(Motor model: NXM940A-J/NXM940M-J)

Gear ratio: 25

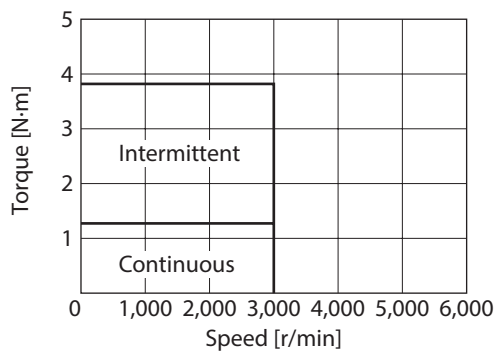
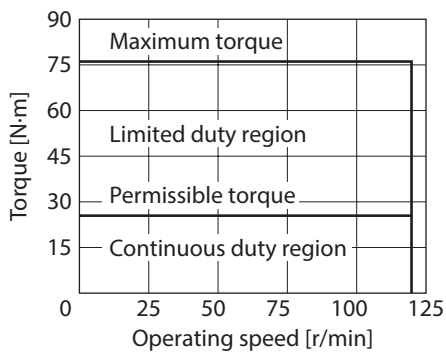

● **NX1075**

Gear ratio: 5

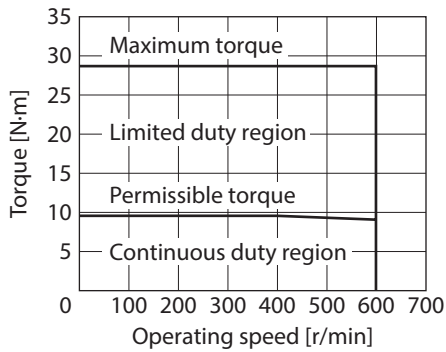

Gear ratio: 10

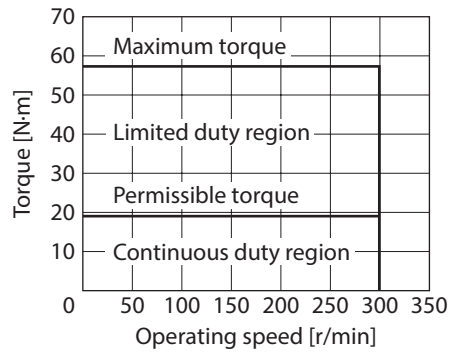

“Speed - Torque Characteristics” for the motor of the **NX1075 PJ** geared type
(Motor model: NXM975A-J/NXM975M-J)

Gear ratio: 25

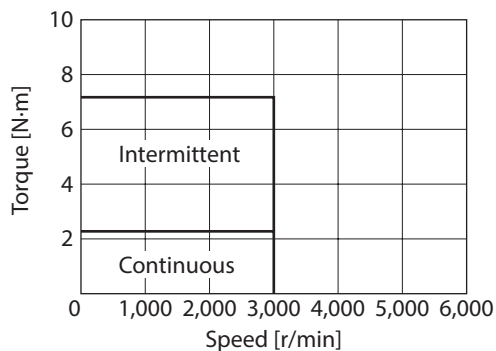
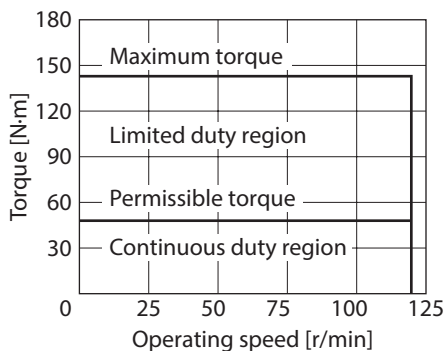

3 Function/parameter list (position control mode)

Item	Overview	Standard specification	Extended function
Control mode	Sets the control mode.	Available	Available
Torque limit	Sets the torque limit value as an analog setting (external potentiometer or external DC voltage).	Available	Available
	Sets the torque limit value per 1 V of analog input voltage.	Not available	Available
	Sets the offset voltage for analog input.	Not available	Available
	Sets whether or not to enable automatic offset for analog input signals.	Not available	Available
	Sets the torque limit value via one of operation data No.0 to No.3 as a digital setting.	Not available	Available
Damping control frequency	Sets the damping control frequency as an analog setting (internal potentiometer VR1). Residual vibration can be suppressed during positioning operation, in order to shorten the positioning time.	Available	Available
	Sets the damping control frequency via one of operation data No.0 to No.3 as a digital setting.	Not available	Available
	Enables damping control.	Available	Available
Operation data selection	Selects one of operation data No.0 to No.3 using the M0 and M1 inputs.	Available	Available
Analog/digital selection	Toggles operation data No.0 between analog setting and digital setting. When the parameter is set to "1: Enable," operation data No.0 becomes an analog setting, while operation data No.1 to No.3 provide digital settings. When the parameter is set to "0: Disable," all operation data numbers provide digital settings.	Not available	Available
Resolution setting	Sets the resolution per pulse. The resolution is calculated by the formula below: Resolution = 1,000 × (Electronic gear B / Electronic gear A) The calculated value should fall within the setting range specified below: Setting range: 100 to 100,000 P/R	Not available	Available
Motor rotation direction	Sets the rotation direction of the motor relative to the input pulse.	Not available	Available
Absolute system	The current position can be stored in the driver. Use our battery BAT01A if the absolute function is to be enabled.	Available	Available
Operation after absolute position loss alarm reset	Sets how the motor should operate after an absolute position loss alarm has been reset, when the absolute system function is used.	Not available	Available
Pulse input	Performs a positioning operation based on pulses input from a pulse generator.	Available	Available

Parameter/operation data				
OPX-2A screen display	MEXE02 tree view	Name	Setting range	Initial value
–	–	–	–	–
–	–	–	–	–
APP-2-03	Analog	Analog torque limit gain	0 to 300 [%]	30
APP-2-05	Analog	Analog torque limit offset voltage	–1.00 to 1.00 [V]	0
APP-2-06	Analog	Analog input signal automatic offset	0: Disable 1: Enable	0
trq	Operation data	Torque limit	0 to 300 [%]	0
–	–	–	–	–
vib	Operation data	Damping frequency	7.00 to 100.00 [Hz]	30.00
APP-4-02	Function	Damping control	0: Disable 1: Enable	1
–	–	–	–	–
SyS-1-05	Operation	Analog input signals	0: Disable 1: Enable	1
SyS-0-00	Electronic gear	Electronic gear A	1 to 1,000	1
SyS-0-01	Electronic gear	Electronic gear B	1 to 1,000	1
SyS-1-06	Operation	Motor rotation direction	0: + = CCW 1: + = CW	1
–	–	–	–	–
SyS-1-01	Operation	Operation after absolute position loss alarm reset	0: Enable pulse input at the ON edge of the P-REQ input 1: Enable pulse input	0
–	–	–	–	–

Item	Overview	Standard specification	Extended function
Pulse input mode selection	Sets the pulse input mode.	Available	Available
S-ON input	This is used to excite the motor to be ready for operation.	Available	Available
	Sets the S-ON input logic.	Not available	Available
READY output	When the motor becomes ready, the READY output will turn ON.	Available	Available
Positioning complete output	When the current position enters the positioning complete output band, the END output will turn ON.	Available	Available
	Sets the output band for positioning complete output.	Not available	Available
Positioning near output	When the current position enters the positioning near output band, the NEAR output will turn ON.	Not available	Available
	Enables the positioning near output.	Not available	Available
	Sets the output band for positioning near output.	Not available	Available
MOVE output	The MOVE output remains ON while the motor is operating.	Not available	Available
	Selects the MOVE output.	Not available	Available
	Sets the minimum ON time for the MOVE output.	Not available	Available
Torque limit enable input	This is used to set the torque limit value in operation data. Use the M0 and M1 inputs to select a desired torque limit value from among the predefined settings.	Available	Available
TLC output	The TLC output will turn ON when the torque limit value is reached.	Available	Available
Deviation counter clear	The internal deviation counter of the driver is reset at the ON edge.	Available	Available
FREE input	This is used to release the electromagnetic brake and stop the motor excitation. The motor output shaft can be rotated by an external force (free-run state). The deviation counter continues to be reset while the FREE input is ON.	Available	Available
MBC output	This is used to output the timing at which to release the electromagnetic brake.	Not available	Available
Position preset	This is used to rewrite the preset value with the current position.	Available	Available
	Sets the preset value.	Not available	Available
Current position output	This is used to output the current position. 56 bits of data that the current position, encoder status, alarm code and checksum are included are output.	Available	Available

Parameter/operation data				
OPX-2A screen display	MEXE02 tree view	Name	Setting range	Initial value
SyS-1-00	Operation	Pulse input mode	0: Setting by the pulse input mode selector switch 1: 2-pulse input mode, negative logic 2: 2-pules input mode, positive logic 3: 1-pulse input mode, negative logic 4: 1-pules input mode, positive logic 5: Phase difference mode, × 1 6: Phase difference mode, × 2 7: Phase difference mode, × 4	0
–	–	–	–	–
APP-1-00	I/O	S-ON signal logic	0: Contact A (normally open) 1: Contact B (normally closed)	0
–	–	–	–	–
–	–	–	–	–
APP-1-04	I/O	Positioning complete output band	0.01 to 36.00 [°]	0.36
–	–	–	–	–
APP-1-03	I/O	Output signal selection 2	0: ZSG2 output 1: NEAR output	0
APP-1-05	I/O	Positioning near output band	0.01 to 36.00 [°]	1.80
–	–	–	–	–
APP-1-02	I/O	Output signal selection 1	0: WNG output 1: MOVE output 2: MBC output	0
APP-1-08	I/O	Minimum ON time for MOVE signal	0 to 255 [ms]	5
–	–	–	–	–
–	–	–	–	–
–	–	–	–	–
–	–	–	–	–
APP-1-02	I/O	Output signal selection 1	0: WNG output 1: MOVE output 2: MBC output	0
–	–	–	–	–
APP-1-09	I/O	Preset value	–2,147,483,648 to 2,147,483,647 [step]	0
–	–	–	–	–

Item	Overview	Standard specification	Extended function
Encoder feedback output	This is used to output the ASG/BSG/ZSG1 (ZSG2) signals based on encoder feedback pulses.	Available	Available
	Sets the encoder feedback pulses per motor evolution. The resolution of encoder feedback pulses is calculated by the formula below: Resolution = 1,000 × (Encoder output electronic gear B / Encoder output electronic gear A) The calculated value should fall within the setting range specified below: Setting range: 100 to 10,000 P/R	Not available	Available
	Selects the ZSG2 output.	Not available	Available
Alarm code	When an alarm generates, a corresponding alarm code will be output based on the READY/P-OUTR output, TLC/P-OUT0 output and ZSG2/NEAR/P-OUT1 output.	Not available	Available
Analog speed monitor	Outputs a voltage according to the detected speed.	Available	Available
	Sets the maximum analog speed to be monitored	Not available	Available
	Sets the maximum voltage for monitored analog speed.	Not available	Available
	Sets the offset value for monitored analog speed.	Not available	Available
Analog torque monitor	Outputs a voltage according to the detected torque.	Available	Available
	Sets the maximum analog torque to be monitored.	Not available	Available
	Sets the maximum voltage for monitored analog torque.	Not available	Available
	Sets the offset value for monitored analog torque.	Not available	Available
Tuning mode selection	Sets the gain tuning mode. Automatic: The load inertial moment is estimated internally by the driver. Simply set the mechanical rigidity, and the gain will be adjusted automatically. Semi-auto: Set the mechanical rigidity and load inertial moment ratio, and the gain will be adjusted automatically. Manual: The customer must set the gain directly.	Not available	Available
Load inertial ratio setting	Sets the percentage of the load inertial moment to the rotor inertial moment of the motor. This ratio is set in semi-auto tuning or manual turning. If the load inertial moment is equal to the rotor inertial moment, the load inertial ratio become 100 %.	Not available	Available
Mechanical rigidity setting switch	Sets the gain adjustment level according to the mechanical rigidity.	Available	Available
Mechanical rigidity selection	Sets whether or not to enable the mechanical rigidity setting switch.	Not available	Available
	Sets the mechanical rigidity as a digital setting.	Not available	Available
Position loop proportional gain	Sets the position loop proportional gain when manual tuning is performed. When the value is increased, the response will increase.	Not available	Available
Speed loop proportional gain	Sets the speed loop proportional gain when manual tuning is performed. When the value is increased, the response will increase.	Not available	Available
Speed loop integral time constant	Sets the speed loop integral time constant when manual tuning is performed. When the value is decreased, the response will increase.	Not available	Available
Speed feed-forward ratio	Sets the speed feed-forward ratio when manual tuning is performed. This setting allows the settling time to be shortened.	Not available	Available

Parameter/operation data				
OPX-2A screen display	MEXE02 tree view	Name	Setting range	Initial value
–	–	–	–	–
SyS-0-02	Electronic gear	Encoder output electronic gear A	1 to 1,000	1
SyS-0-03	Electronic gear	Encoder output electronic gear B	1 to 1,000	1
APP-1-03	I/O	Output signal selection 2	0: ZSG2 output 1: NEAR output	0
APP-1-10	I/O	Alarm code output	0: Disable 1: Enable	0
–	–	–	–	–
APP-2-07	Analog	Analog speed monitor maximum value	1 to 6,000 [r/min]	5,500
APP-2-08	Analog	Analog speed monitor maximum voltage	1 to 10 [V]	10
APP-2-09	Analog	Analog speed monitor offset voltage	–1.00 to 1.00 [V]	0
–	–	–	–	–
APP-2-10	Analog	Analog torque monitor maximum value	1 to 300 [%]	300
APP-2-11	Analog	Analog torque monitor maximum voltage	1 to 10 [V]	10
APP-2-12	Analog	Analog torque monitor offset voltage	–1.00 to 1.00 [V]	0
APP-0-00	Gain	Gain tuning mode selection	0: Automatic 1: Semi-auto 2: Manual	0
APP-0-01	Gain	Load inertial moment ratio	0 to 10,000 [%]	500
–	–	–	–	–
APP-4-00	Function	Mechanical rigidity setting switch	0: Disable 1: Enable	1
APP-0-02	Gain	Mechanical rigidity settings	0 to 15	6
APP-0-03	Gain	Position loop gain	1 to 200 [Hz]	10
APP-0-04	Gain	Speed loop gain	1 to 1,000 [Hz]	50
APP-0-05	Gain	Speed loop integral time constant	1.0 to 500.0 [ms]	31.8
APP-0-06	Gain	Speed feed-forward ratio	0 to 100 [%]	0

Item	Overview	Standard specification	Extended function
Command filter	Applies a filter to the pulse input command to make the operation smooth.	Available	Available
Damping control	Suppresses residual vibration during positioning, in order to shorten the positioning time.	Available	Available
Data-setter initial display	Sets the initial screen on the OPX-2A . In the position control mode, the top screen of the monitor mode will become the initial display if the selected item cannot be displayed.	Not available	Available
	Sets whether it is possible to edit using the OPX-2A .	Not available	Available
	Shows the speed on the OPX-2A with a sign or as an absolute value.	Not available	Available
JOG operation	Sets the operating speed of JOG operation.	Not available	Available
Speed monitor	The deceleration rate can be set when the actual speed for the output shaft of the geared motor is monitored.	Not available	Available

Parameter/operation data				
OPX-2A screen display	MEXE02 tree view	Name	Setting range	Initial value
APP-4-01	Function	Command filter	0 to 100 [ms]	3
APP-4-02	Function	Damping control	0: Disable 1: Enable	1
SyS-1-07	Operation	Data-setter initial display	0: Operating speed [r/min] 1: Position [steps] 2: Torque [%] 3: Estimated inertial moment ratio [%] 4: Operation number 5: Selected number 6: Tension [%] 7: Revolution counter [rev] 8: Roll diameter [mm] 9: Top screen of monitor mode	0
–	Manual operation and display	Data setter edit	0: Disable 1: Enable	1
APP-5-02	Manual operation and display	Data setter speed display	0: Signed 1: Absolute value	0
APP-5-00	Manual operation and display	JOG operating speed	1 to 300 [r/min]	30
APP-4-05	Function	Deceleration rate of speed monitor	1.0 to 100.0	1.0

4 Function/parameter list (speed control mode)

Item	Overview	Standard specification	Extended function
Control mode	Sets the control mode.	Available	Available
Speed command	Sets the speed command value via operation data No.0 or No.1 as an analog setting (internal potentiometer VR1, external potentiometer or external DC voltage). Operation data No.2 to No.7 provide digital settings.	Available	Available
	Sets the speed command value per 1 V of analog input voltage.	Not available	Available
	Sets the speed at which to clamp the analog input to zero.	Not available	Available
	Sets the offset voltage for analog input.	Not available	Available
	Sets whether or not to enable automatic offset for analog input signals.	Not available	Available
	Sets the speed command value via one of operation data No.0 to No.7 as a digital setting.	Not available	Available
Torque limit	Sets the torque limit value via operation data No.0 or No.1 as an analog setting (internal potentiometer VR1, external potentiometer or external DC voltage). Operation data No.2 to No.7 provide digital settings.	Available	Available
	Sets the torque limit value per 1 V of analog input voltage.	Not available	Available
	Sets the offset voltage for analog input.	Not available	Available
	Sets whether or not to enable automatic offset for analog input signals.	Not available	Available
	Sets the torque limit value via one of operation data No.0 to No.7 as a digital setting.	Not available	Available
Acceleration/ deceleration time.	Sets the acceleration/deceleration time via operation data No.0 or No.1 as an analog setting (internal potentiometer VR2). The acceleration time and deceleration time are the same.	Available	Available
	Sets the acceleration time via one of operation data No.0 to No.7 as a digital setting.	Not available	Available
	Sets the deceleration time via one of operation data No.0 to No.7 as a digital setting.	Not available	Available
Operation data selection	Selects one of operation data No.0 to No.7 using the M0 to M2 inputs.	Available	Available
Analog/digital selection	Toggles operation data No.0 and No.1 between analog setting and digital setting. When this parameter is set to "1: Enable," operation data No.0 and No.1 become analog settings, while No.2 to No.7 provide digital settings. When the parameter is set to "0: Disable," all operation data numbers provide digital settings.	Not available	Available
Motor rotation direction	Sets the rotation direction of the motor.	Not available	Available
Operation after stopping	Sets how the motor should operate after stopping.	Not available	Available

Parameter/operation data				
OPX-2A screen display	MEXE02 tree view	Name	Setting range	Initial value
–	–	–	–	–
–	–	–	–	–
APP-2-00	Analog	Analog speed command gain	0 to 5,500 [r/min]	550
APP-2-01	Analog	Analog speed command clamp	0 to 500 [r/min]	10
APP-2-02	Analog	Analog speed command offset voltage	–1.00 to 1.00 [V]	0
APP-2-06	Analog	Analog input signal automatic offset	0: Disable 1: Enable	0
rEv	Operation data	Operating speed	0 to 5,500 [r/min]	0
–	–	–	–	–
APP-2-03	Analog	Analog torque limit gain	0 to 300 [%]	30
APP-2-05	Analog	Analog torque limit offset voltage	–1.00 to 1.00 [V]	0
APP-2-06	Analog	Analog input signal automatic offset	0: Disable 1: Enable	0
trq	Operation data	Torque limit	0 to 300 [%]	0
–	–	–	–	–
tA	Operation data	Acceleration time	5 to 10,000 [ms / 1,000 r/min]	100
td	Operation data	Deceleration time	5 to 10,000 [ms / 1,000 r/min]	100
–	–	–	–	–
SyS-1-05	Operation	Analog input signals	0: Disable 1: Enable	1
SyS-1-07	Operation	Motor rotation direction	0: + = CCW 1: + = CW	1
SyS-1-02	Operation	Operation selection after stopping in speed control mode	0: Free 1: Servo lock	0

Item	Overview	Standard specification	Extended function
S-ON input	This is used to excite the motor to be ready for operation.	Not available	Available
	Sets the S-ON input logic.	Not available	Available
READY output	When the motor becomes ready, the READY output will turn ON.	Available	Available
Forward/reverse	Starts operating in forward or reverse direction.	Available	Available
Instantaneous stop	Stops the motor instantaneously.	Available	Available
	Sets the BRAKE input logic.	Not available	Available
ZV output	The ZV output will turn ON when the detected speed drops into the speed range set by the zero speed output band.	Not available	Available
	Sets the band within which the ZV output turns ON.	Not available	Available
VA output	The VA output will turn ON when the operating speed reaches the speed range set by the attained speed output band.	Available	Available
	Sets the band within which the VA output turns ON.	Not available	Available
MOVE output	The MOVE output remains ON while the motor is operating.	Available	Available
	Selects the MOVE output.	Not available	Available
	Sets the minimum ON time for the MOVE output.	Not available	Available
FREE input	This is used to release the electromagnetic brake and stop the motor excitation. The motor output shaft can be rotated by an external force (free-run state). The deviation counter continues to be reset while the FREE input is ON.	Available	Available
MBC output	This is used to output the timing at which to release the electromagnetic brake.	Not available	Available
Torque limit enable input	This is used to enable the torque limit value. Use the M0 to M2 inputs to select a desired torque limit value from among the predefined settings.	Available	Available
TLC output	The TLC output will turn ON when the detected torque reaches the torque limit value.	Available	Available
Encoder feedback output	This is used to output the ASG/BSG/ZSG1 (ZSG2) signals based on encoder feedback pulses.	Available	Available
	Sets the encoder feedback pulses per motor evolution. The resolution of encoder feedback pulses is calculated by the formula below: Resolution = 1,000 × (Encoder output electronic gear B / Encoder output electronic gear A) The calculated value should fall within the setting range specified below: Setting range: 100 to 10,000 P/R	Not available	Available
	Selects the ZSG2 output.	Not available	Available
Alarm code	When an alarm generates, a corresponding alarm code will be output based on the READY output, TLC output and ZSG2/ZV output.	Not available	Available

Parameter/operation data				
OPX-2A screen display	MEXE02 tree view	Name	Setting range	Initial value
–	–	–	–	–
APP-1-00	I/O	S-ON signal logic	0: Contact A (normally open) 1: Contact B (normally closed)	0
–	–	–	–	–
–	–	–	–	–
–	–	–	–	–
APP-1-01	I/O	BRAKE signal logic	0: Contact A (normally open) 1: Contact B (normally closed)	1
APP-1-03	I/O	Output signal selection 2	0: ZSG2 output 1: ZV output	0
APP-1-06	I/O	Zero speed output band	1 to 5,500 [r/min]	10
–	–	–	–	–
APP-1-07	I/O	Attained speed output band	1 to 5,500 [r/min]	30
–	–	–	–	–
APP-1-02	I/O	Output signal selection 1	0: WNG output 1: MOVE output 2: MBC output	0
APP-1-08	I/O	Minimum ON time for MOVE signal	0 to 255 [ms]	5
–	–	–	–	–
APP-1-02	I/O	Output signal selection 1	0: WNG output 1: MOVE output 2: MBC output	0
–	–	–	–	–
–	–	–	–	–
–	–	–	–	–
SyS-0-02	Electronic gear	Encoder output electronic gear A	1 to 1,000	1
SyS-0-03	Electronic gear	Encoder output electronic gear B	1 to 1,000	1
APP-1-03	I/O	Output signal selection 2	0: ZSG2 output 1: NEAR output	0
APP-1-10	I/O	Alarm code output	0: Disable 1: Enable	0

Item	Overview	Standard specification	Extended function
Analog speed monitor	Outputs a voltage according to the detected speed.	Available	Available
	Sets the maximum analog speed to be monitored.	Not available	Available
	Sets the maximum voltage for monitored analog speed.	Not available	Available
	Sets the offset value for monitored analog speed.	Not available	Available
Analog torque monitor	Outputs a voltage according to the detected torque.	Available	Available
	Sets the maximum analog torque to be monitored.	Not available	Available
	Sets the maximum voltage for monitored analog torque.	Not available	Available
	Sets the offset value for monitored analog torque.	Not available	Available
Tuning mode selection	Sets the gain tuning mode. Automatic: The load inertial moment is estimated internally by the driver. Simply set the mechanical rigidity, and the gain will be adjusted automatically. Semi-auto: Set the mechanical rigidity and load inertial moment ratio, and the gain will be adjusted automatically. Manual: The customer must set the gain directly.	Not available	Available
Load inertial ratio setting	Sets the percentage of the load inertial moment to the rotor inertial moment of the motor. This ratio is set in semi-auto tuning or manual turning. If the load inertial moment is equal to the rotor inertial moment, the load inertial ratio becomes 100 %.	Not available	Available
Mechanical rigidity setting switch	Sets the gain adjustment level according to the mechanical rigidity.	Available	Available
Mechanical rigidity selection	Sets whether or not to enable the mechanical rigidity setting switch.	Not available	Available
	Sets the mechanical rigidity as a digital setting.	Not available	Available
Position loop proportional gain	Sets the position loop proportional gain when manual tuning is performed. When the value is increased, the response will increase.	Not available	Available
Speed loop proportional gain	Sets the speed loop proportional gain when manual tuning is performed. When the value is increased, the response will increase.	Not available	Available
Speed loop integral time constant	Sets the speed loop integral time constant when manual tuning is performed. When the value is decreased, the response will increase.	Not available	Available
Speed feed-forward ratio	Sets the speed feed-forward ratio when manual tuning is performed. This setting allows the settling time to be shortened.	Not available	Available
Data-setter initial display	Sets the initial screen on the OPX-2A . In the position control mode, the top screen of the monitor mode will become the initial display if the selected item cannot be displayed.	Not available	Available
	Sets whether it is possible to edit using the OPX-2A .	Not available	Available
	Shows the speed on the OPX-2A with a sign or as an absolute value.	Not available	Available
JOG operation	Sets the operating speed of JOG operation.	Not available	Available

Parameter/operation data				
OPX-2A screen display	MEXE02 tree view	Name	Setting range	Initial value
–	–	–	–	–
APP-2-07	Analog	Analog speed monitor maximum value	1 to 6,000 [r/min]	5,500
APP-2-08	Analog	Analog speed monitor maximum voltage	1 to 10 [V]	10
APP-2-09	Analog	Analog speed monitor offset voltage	–1.00 to 1.00 [V]	0
–	–	–	–	–
APP-2-10	Analog	Analog torque monitor maximum value	1 to 300 [%]	300
APP-2-11	Analog	Analog torque monitor maximum voltage	1 to 10 [V]	10
APP-2-12	Analog	Analog torque monitor offset voltage	–1.00 to 1.00 [V]	0
APP-0-00	Gain	Gain tuning mode selection	0: Automatic 1: Semi-auto 2: Manual	0
APP-0-01	Gain	Load inertia moment ratio	0 to 10,000 [%]	500
–	–	–	–	–
APP-4-00	Function	Mechanical rigidity setting switch	0: Disable 1: Enable	1
APP-0-02	Gain	Mechanical rigidity setting	0 to 15	6
APP-0-03	Gain	Position loop gain	1 to 200 [Hz]	10
APP-0-04	Gain	Speed loop gain	1 to 1,000 [Hz]	50
APP-0-05	Gain	Speed loop integral time constant	1.0 to 500.0 [ms]	31.8
APP-0-06	Gain	Speed feed-forward ratio	0 to 100 [%]	0
SyS-1-07	Operation	Data-setter initial display	0: Operating speed [r/min] 1: Position [steps] 2: Torque [%] 3: Estimated inertial moment ratio [%] 4: Operation number 5: Selected number 6: Tension [%] 7: Revolution counter [rev] 8: Roll diameter [mm] 9: Top screen of monitor mode	0
–	Manual operation and display	Data setter edit	0: Disable 1: Enable	1
APP-5-02	Manual operation and display	Data setter speed display	0: Signed 1: Absolute value	0
APP-5-00	Manual operation and display	JOG operating speed	1 to 300 [r/min]	30

Function/parameter list (speed control mode)

Item	Overview	Standard specification	Extended function
Speed monitor	The deceleration rate can be set when the actual speed for the output shaft of the geared motor is monitored.	Not available	Available

Parameter/operation data				
OPX-2A screen display	MEXE02 tree view	Name	Setting range	Initial value
APP-4-05	Function	Deceleration rate of speed monitor	1.0 to 100.0	1.0

5 Function/parameter list (torque control mode)

Item	Overview	Standard specification	Extended function
Control mode	Sets the control mode.	Available	Available
Torque command	Sets the torque command value via operation data No.0 or No.1 as an analog setting (internal potentiometer VR1, external potentiometer or external DC voltage). Operation data No.2 to No.7 provide digital settings.	Available	Available
	Sets the torque command value per 1 V of analog input voltage.	Not available	Available
	Sets the offset voltage for analog input.	Not available	Available
	Sets whether or not to enable automatic offset for analog input signals.	Not available	Available
	Sets the torque command value via one of operation data No.0 to No.7 as a digital setting.	Not available	Available
Speed limit	Sets the speed limit value via operation data No.0 or No.1 as an analog setting (internal potentiometer VR2, external potentiometer or external DC voltage). Operation data No.2 to No.7 provide digital settings.	Available	Available
	Sets the speed limit value per 1 V of analog input voltage.	Not available	Available
	Sets the offset voltage for analog input.	Not available	Available
	Sets whether or not to enable automatic offset for analog input signals.	Not available	Available
	Sets the speed limit value via one of operation data No.0 to No.7 as a digital setting.	Not available	Available
Operation data selection	Selects one of operation data No.0 to No.7 using the M0 to M2 inputs.	Available	Available
Analog/digital selection	Toggles operation data No.0 and No.1 between analog setting and digital setting. When this parameter is set to "1: Enable," operation data No.0 and No.1 become analog settings, while No.2 to No.7 provide digital settings. When the parameter is set to "0: Disable," all operation data numbers provide digital settings.	Not available	Available
Motor rotation direction	Sets the direction in which motor torque generates.	Not available	Available
READY output	When the motor becomes ready, the READY output will turn ON.	Available	Available
Forward/reverse	Starts operating in forward or reverse direction. With an analog setting, the rotation direction changes depending on the voltage.	Available	Available
MOVE output	The MOVE output remains ON while the motor is operating.	Available	Available
	Selects the MOVE output.	Not available	Available
	Sets the minimum ON time for the MOVE output.	Not available	Available
FREE input	This is used to release the electromagnetic brake and stop the motor excitation. The motor output shaft can be rotated by an external force (free-run state).	Available	Available

Parameter/operation data				
OPX-2A screen display	MEXE02 tree view	Name	Setting range	Initial value
–	–	–	–	–
–	–	–	–	–
APP-2-03	Analog	Analog torque command gain	0 to 300 [%]	30
APP-2-05	Analog	Analog torque command offset voltage	–1.00 to 1.00 [V]	0
APP-2-06	Analog	Analog input signal automatic offset	0: Disable 1: Enable	0
trq	Operation data	Torque command	0 to 300 [%]	0
–	–	–	–	–
APP-2-00	Analog	Analog speed limit gain	0 to 5,500 [r/min]	550
APP-2-02	Analog	Analog speed limit offset voltage	–1.00 to 1.00 [V]	0
APP-2-06	Analog	Analog input signal automatic offset	0: Disable 1: Enable	0
rEv	Operation data	Speed limit	0 to 5,500 [r/min]	0
–	–	–	–	–
SyS-1-05	Operation	Analog input signals	0: Disable 1: Enable	1
SyS-1-06	Operation	Motor rotation direction	0: + = CCW 1: + = CW	1
–	–	–	–	–
–	–	–	–	–
–	–	–	–	–
APP-1-02	I/O	Output signal selection 1	0: WNG output 1: MOVE output 2: MBC output	0
APP-1-08	I/O	Minimum ON time for MOVE signal	0 to 255 [ms]	5
–	–	–	–	–

Item	Overview	Standard specification	Extended function
MBC output	This is used to output the timing at which to release the electromagnetic brake.	Not available	Available
Encoder feedback output	This is used to output the ASG/BSG/ZSG1 (ZSG2) signals based on encoder feedback pulses.	Available	Available
	Sets the encoder feedback pulses per motor evolution. The resolution of encoder feedback pulses is calculated by the formula below: Resolution = $1,000 \times (\text{Encoder output electronic gear B} / \text{Encoder output electronic gear A})$ The calculated value should fall within the setting range specified below: Setting range: 100 to 10,000 P/R	Not available	Available
	Selects the ZSG2 output.	Not available	Available
ZV output	The ZV output will turn ON when the detected speed drops into the speed range set by the zero speed output band.	Not available	Available
	Sets the band within which the ZV output turns ON.	Not available	Available
Alarm code	When an alarm generates, a corresponding alarm code will be output based on the READY output, VLC output and ZSG2/ZV output.	Not available	Available
Analog speed monitor	Outputs a voltage according to the detected speed.	Available	Available
	Sets the maximum analog speed to be monitored.	Not available	Available
	Sets the maximum voltage for monitored analog speed.	Not available	Available
	Sets the offset value for monitored analog speed.	Not available	Available
Analog torque monitor	Outputs a voltage according to the detected torque.	Available	Available
	Sets the maximum analog torque to be monitored.	Not available	Available
	Sets the maximum voltage for monitored analog torque.	Not available	Available
	Sets the offset value for monitored analog torque.	Not available	Available
Data-setter initial display	Sets the initial screen on the OPX-2A . In the torque control mode, the top screen of the monitor mode will become the initial display if the selected item cannot be displayed.	Not available	Available

Parameter/operation data				
OPX-2A screen display	MEXE02 tree view	Name	Setting range	Initial value
APP-1-02	I/O	Output signal selection 1	0: WNG output 1: MOVE output 2: MBC output	0
–	–	–	–	–
SyS-0-02	Electronic gear	Encoder output electronic gear A	1 to 1,000	1
SyS-0-03	Electronic gear	Encoder output electronic gear B	1 to 1,000	1
APP-1-03	I/O	Output signal selection 2	0: ZSG2 output 1: NEAR output	0
APP-1-03	I/O	Output signal selection 2	0: ZSG2 output 1: ZV output	0
APP-1-06	I/O	Zero speed output band	1 to 5,500 [r/min]	10
APP-1-10	I/O	Alarm code output	0: Disable 1: Enable	0
–	–	–	–	–
APP-2-07	Analog	Analog speed monitor maximum value	1 to 6,000 [r/min]	5,500
APP-2-08	Analog	Analog speed monitor maximum voltage	1 to 10 [V]	10
APP-2-09	Analog	Analog speed monitor offset voltage	–1.00 to 1.00 [V]	0
–	–	–	–	–
APP-2-10	Analog	Analog torque monitor maximum value	1 to 300 [%]	300
APP-2-11	Analog	Analog torque monitor maximum voltage	1 to 10 [V]	10
APP-2-12	Analog	Analog torque monitor offset voltage	–1.00 to 1.00 [V]	0
SyS-1-07	Operation	Data-setter initial display	0: Operating speed [r/min] 1: Position [steps] 2: Torque [%] 3: Estimated inertial moment ratio [%] 4: Operation number 5: Selected number 6: Tension [%] 7: Revolution counter [rev] 8: Roll diameter [mm] 9: Top screen of monitor mode	0

6 Function/parameter list (tension control mode)

Item	Overview	Standard specification	Extended function
Control mode	Sets the control mode.	Available	Available
Tension control mode	<p>Selects the tension control mode.</p> <p>Simple: The tension is controlled at a constant level when the feed rate is constant during winding operation, etc.</p> <p>High function I: The current winding (unwinding) diameter is calculated automatically based on the initial diameter, material thickness and final diameter. The tension is controlled at a constant level regardless of the operating speed.</p> <p>High function II: In addition to the control in high function mode I, the load inertial moment is calculated internally by the driver based on the material inertial moment and core inertial moment. The tension is controlled at a constant level even during acceleration/deceleration.</p>	Not available	Available
Tension command	Sets the tension command value via operation data No.0 or No.1 as an analog setting (internal potentiometer VR1, external potentiometer or external DC voltage). Operation data No.2 to No.7 provide digital settings.	Available	Available
	Sets the tension command value per 1 V of analog input voltage.	Not available	Available
	Sets the offset voltage for analog input.	Not available	Available
	Sets whether or not to enable automatic offset for analog input signals.	Not available	Available
	Sets the tension command value via one of operation data No.0 to No.7 as a digital setting.	Not available	Available
Speed limit	Sets the speed limit value via operation data No.0 or No.1 as an analog setting (internal potentiometer VR2, external potentiometer or external DC voltage). Operation data No.2 to No.7 provide digital settings.	Available	Available
	Sets the speed limit value per 1 V of analog input voltage.	Not available	Available
	Sets the offset voltage for analog input.	Not available	Available
	Set whether or not to enable automatic offset for analog input signals.	Not available	Available
	Sets the speed limit value via one of operation data No.0 to No.7 as a digital setting.	Not available	Available
Material thickness	Sets the change in radius (material thickness) per one revolution of the winding (unwinding) shaft in high function mode I or high function mode II.	Not available	Available
Initial diameter	Sets the material diameter at the start of winding or unwinding in high function mode I or high function mode II.	Not available	Available
Maximum diameter	Sets the material diameter at the end of winding or unwinding in high function mode I or high function mode II.	Not available	Available
Material inertial moment	Sets the inertial moment corresponding to the maximum material diameter in high function mode I or high function mode II.	Not available	Available
Core inertial moment	Sets the inertial moment of the core around which material is set, in high function mode II.	Not available	Available

Parameter/operation data				
OPX-2A screen display	MEXE02 tree view	Name	Setting range	Initial value
–	–	–	–	–
SyS-1-03	Operation	Tension control mode selection	0: Simple 1: High function I 2: High function II	0
–	–	–	–	–
APP-2-04	Analog	Analog tension command gain	0 to 100 [%]	10
APP-2-05	Analog	Analog tension command offset voltage	–1.00 to 1.00 [V]	0
APP-2-06	Analog	Analog input signal automatic offset	0: Disable 1: Enable	0
tEn	Operation data	Tension command	0 to 100 [%]	0
–	–	–	–	–
APP-2-00	Analog	Analog speed limit gain	0 to 5,500 [r/min]	550
APP-2-02	Analog	Analog speed limit offset voltage	–1.00 to 1.00 [V]	0
APP-2-06	Analog	Analog input signal automatic offset	0: Disable 1: Enable	0
rEv	Operation data	Speed limit	0 to 5,500 [r/min]	0
dt	Operation data	Material thickness	1 to 5,000 [μm]	50
din	Operation data	Initial diameter	1 to 1,000 [mm]	500
dPK	Operation data	Final diameter	1 to 1,000 [mm]	1,000
JL	Operation data	Material inertia moment	0 to 99,999.99 [× 10 ^{–4} kgm ²]	0
Jc	Operation data	Core inertia moment	0 to 99,999.99 [× 10 ^{–4} kgm ²]	0

Item	Overview	Standard specification	Extended function
Taper setting	Reduces the tension according to the change in the roll diameter to prevent excessively tight winding, in high function mode II.	Not available	Available
Deceleration rate of tension control	Sets the ratio of the motor shaft speed and the winding shaft speed.	Not available	Available
Operation data selection	Selects one of operation data No.0 to No.7 using the M0 to M2 inputs.	Available	Available
Analog/digital selection	Toggles operation data No.0 and No.1 between analog setting and digital setting. When this parameter is set to "1: Enable," operation data No.0 and No.1 become analog settings, while No.2 to No.7 provide digital settings. When the parameter is set to "0: Disable," all operation data numbers provide digital settings.	Not available	Available
READY output	When the motor becomes ready, the READY output will turn ON.	Available	Available
Forward/reverse	Starts operating in forward or reverse direction.	Available	Available
ZV output	The ZV output will turn ON when the detected speed drops into the speed range set by the zero speed output band.	Not available	Available
	Sets the band within which the ZV output turns ON.	Not available	Available
Acceleration/deceleration correction filter	Sets the correction filter time constant for acceleration/deceleration in high function mode II. Increase the value if vibration occurs when the motor accelerates/decelerates during winding operation.	Not available	Available
Friction torque correction	Corrects the torque load based on the friction of mechanical parts in high function mode I or high function mode II. The value is based on the torque detected during idle operation.	Not available	Available
W-RESET input	This is used to reset the roll diameter of the winding shaft to the initial value.	Available	Available
Encoder feedback output	This is used to output the ASG/BSG/ZSG1 (ZSG2) signals based on encoder feedback pulses.	Available	Available
	Sets the encoder feedback pulses per motor evolution. The resolution of encoder feedback pulses is calculated by the formula below: Resolution = $1,000 \times (\text{Encoder output electronic gear B} / \text{Encoder output electronic gear A})$ The calculated value should fall within the setting range specified below: Setting range: 100 to 10,000 P/R	Not available	Available
	Selects the ZSG2 output.	Not available	Available
Alarm code	When an alarm generates, a corresponding alarm code will be output based on the READY output, VLC output and ZSG2/ZV output.	Not available	Available
Analog speed monitor	Outputs a voltage according to the detected speed.	Available	Available
	Sets the maximum analog speed to be monitored.	Not available	Available
	Sets the maximum voltage for monitored analog speed.	Not available	Available
	Sets the offset value for monitored analog speed.	Not available	Available
Analog torque monitor	Outputs a voltage according to the detected torque.	Available	Available
	Sets the maximum analog torque to be monitored.	Not available	Available
	Sets the maximum voltage for monitored analog torque.	Not available	Available
	Sets the offset value for monitored analog torque.	Not available	Available

Parameter/operation data				
OPX-2A screen display	MEXE02 tree view	Name	Setting range	Initial value
tEP	Operation data	Taper setting	0 to 100 [%]	100
SyS-1-04	Operation	Deceleration rate of tension control	1.0 to 1,000.0	1.0
–	–	–	–	–
SyS-1-05	Operation	Analog input signals	0: Disable 1: Enable	1
–	–	–	–	–
–	–	–	–	–
APP-1-03	I/O	Output signal selection 2	0: ZSG2 output 1: ZV output	0
APP-1-06	I/O	Zero speed output band	1 to 5,500 [r/min]	10
APP-4-03	Function	Acceleration/deceleration correction filter	10 to 500 [ms]	100
APP-4-04	Function	Frictional torque correction	0 to 50 [%]	0
–	–	–	–	–
–	–	–	–	–
SyS-0-02	Electronic gear	Encoder output electronic gear A	1 to 1,000	1
SyS-0-03	Electronic gear	Encoder output electronic gear B	1 to 1,000	1
APP-1-03	I/O	Output signal selection 2	0: ZSG2 output 1: NEAR output	0
APP-1-10	I/O	Alarm code output	0: Disable 1: Enable	0
–	–	–	–	–
APP-2-07	Analog	Analog speed monitor maximum value	1 to 6,000[r/min]	5,500
APP-2-08	Analog	Analog speed monitor maximum voltage	1 to 10 [V]	10
APP-2-09	Analog	Analog speed monitor offset voltage	–1.00 to 1.00 [V]	0
–	–	–	–	–
APP-2-10	Analog	Analog torque monitor maximum value	1 to 300 [%]	300
APP-2-11	Analog	Analog torque monitor maximum voltage	1 to 10 [V]	10
APP-2-12	Analog	Analog torque monitor offset voltage	–1.00 to 1.00 [V]	0

Item	Overview	Standard specification	Extended function
MOVE output	The MOVE output remains ON while the motor is operating.	Available	Available
	Selects the MOVE output.	Not available	Available
	Sets the minimum ON time for the MOVE output.	Not available	Available
FREE input	This is used to release the electromagnetic brake and stop the motor excitation. The motor output shaft can be rotated by an external force (free-run state).	Available	Available
MBC output	This is used to output the timing at which to release the electromagnetic brake.	Not available	Available
Motor rotation direction	Sets the direction in which motor torque generates.	Not available	Available
Data-setter initial display	Sets the initial screen on the OPX-2A . In the torque control mode, the top screen of the monitor mode will become the initial display if the selected item cannot be displayed.	Not available	Available

Parameter/operation data				
OPX-2A screen display	MEXE02 tree view	Name	Setting range	Initial value
–	–	–	–	–
APP-1-02	I/O	Output signal selection 1	0: WNG output 1: MOVE output 2: MBC output	0
APP-1-08	I/O	Minimum ON time for MOVE signal	0 to 255 [ms]	5
–	–	–	–	–
APP-1-02	I/O	Output signal selection 1	0: WNG output 1: MOVE output 2: MBC output	0
SyS-1-06	Operation	Motor rotation direction	0: + = CCW 1: + = CW	1
SyS-1-07	Operation	Data-setter initial display	0: Operating speed [r/min] 1: Position [steps] 2: Torque [%] 3: Estimated inertial moment ratio [%] 4: Operation number 5: Selected number 6: Tension [%] 7: Revolution counter [rev] 8: Roll diameter [mm] 9: Top screen of monitor mode	0

7 Alarm list

Item		Overview/condition
Alarm check function	LED indicator	When an alarm generates, the ALARM LED on the front face of the driver will blink. The number of times the LED blinks varies depending on the content of the alarm.
ALM output	ALM output	This signal will be output when an alarm generates.
Alarm code output	Alarm code output (AL0 to AL2 output)	This alarm is used to allow the programmable controller to detect the content of each alarm that has generated.
	Alarm code output enable/disable setting	Enables alarm code output if you want alarm codes to be output.
Alarm reset	Turn on the power supply again/reconnection	Resets alarms by turning the main power supply again.
	ALM-RST input	Resets alarms by inputting the ALM-RST input.
Alarm detection condition setting	Excessive position deviation alarm	Sets the condition under which an excessive position deviation alarm generates, as an amount of rotation of the motor shaft.
Descriptions of alarms	Overheat protection	The internal temperature of the driver exceeded approximately 85 °C (185 °F).
	Motor overheat generation	The motor temperature reached approximately 85 °C (185 °F).
	Overload	A load exceeding the rated torque was applied.
	Overspeed	The detected motor speed exceeded 6,000 r/min.
	Command pulse error	The command pulse frequency exceeded the specified value.
	Regeneration resistor overheat	<ul style="list-style-type: none"> The regeneration resistor is not connected correctly. The regeneration resistor is overheating.
	Overvoltage protection	<ul style="list-style-type: none"> 200-230 VAC was applied to a product specified for 100-150 VAC. A large inertial load was stopped abruptly, or up/down operation was performed without connecting a regeneration resistor. The regeneration resistor is not connected correctly. The DC voltage of the main power supply became approximately 400 V or higher.
	Main power supply error	The motor was started when the main power was cut off.
	Undervoltage	The main power supply was shut off momentarily or a voltage shortage was generated.
	Excessive position deviation	<ul style="list-style-type: none"> The deviation between the command position and actual position at the motor output shaft exceeded the value set in the excessive position deviation alarm parameter. (Initial value: 10 rev) The load is large or the acceleration/deceleration time is short.
	Overcurrent protection	The motor, cable or driver output circuit was shorted.
Position range error	<ul style="list-style-type: none"> The command position exceeded the coordinate control range (-2,147,483,648 to 2,147,483,647). The multi-rotation data for internal encoder coordinates exceeded the coordinate control range (-32,768 to 32,767). (This alarm generates when the absolute system function is used in the position control mode.) 	
Absolute position loss	<ul style="list-style-type: none"> The power was turned on for the first time after connecting the battery. No battery is connected, the battery cable is disconnected, or the battery has been consumed. The encoder cable came off. The position range error alarm was reset. <p>(This alarm generates when the absolute system function is used in the position control mode.)</p>	

Standard specification	Extended function	Parameter/operation data			
		OPX-2A screen display	Name	Setting range	Initial value
Available	Available	–	–	–	–
Available	Available	–	–	–	–
Not available	Available	–	–	–	–
Not available	Available	APP-1-10	Alarm code output	0: Disable 1: Enable	0: Disable
Available	Available	–	–	–	–
Available	Available	–	–	–	–
Not available	Available	APP-3-00	Excessive position deviation alarm	1 to 1,000 [rev]	10
Available	Available	–	–	–	–
Available	Available	–	–	–	–
Available	Available	–	–	–	–
Available	Available	–	–	–	–
Available	Available	–	–	–	–
Available	Available	–	–	–	–
Available	Available	–	–	–	–
Available	Available	–	–	–	–
Available	Available	–	–	–	–
Available	Available	–	–	–	–
Available	Available	–	–	–	–
Available	Available	–	–	–	–
Available	Available	–	–	–	–
Available	Available	–	–	–	–
Available	Available	–	–	–	–

Item		Overview/condition
Descriptions of alarms	ABS not supported	The battery was detected when the absolute function was disabled in the position control mode.
	No battery	No battery was detected or the battery cable was disconnected when the absolute function was enabled.
	Electronic gear setting error	The power was turned on when the resolution set by the electronic gear and encoder output electronic gear was outside the specified range.
	Sensor error during operation	An encoder error was detected during operation.
	Encoder communication error	A communication error occurred between the driver and encoder.
	Sensor error during initialization	An encoder error was detected when the power was turned on.
	Rotor rotation during initialization	The motor output shaft rotated by 1/40th of a revolution during the initialization following a power on.
	Encoder EEPROM error	Data stored in the encoder communication circuit was damaged.
	Motor combination error	A motor not supported by the driver is connected.
	EEPROM error	Data stored in the driver was damaged.
CPU error	CPU malfunctioned.	

Standard specification	Extended function	Parameter/operation data			
		OPX-2A screen display	Name	Setting range	Initial value
Available	Available	–	–	–	–
Available	Available	–	–	–	–
Available	Available	–	–	–	–
Available	Available	–	–	–	–
Available	Available	–	–	–	–
Available	Available	–	–	–	–
Available	Available	–	–	–	–
Available	Available	–	–	–	–
Available	Available	–	–	–	–
Available	Available	–	–	–	–
Available	Available	–	–	–	–
Available	Available	–	–	–	–

8 Warnings list

	Item	Overview/condition
Warning check function	WNG output	When a warning generates, the WNG output will turn ON.
Warning detection condition setting	Excessive position deviation warning	Sets the condition under which an excessive position deviation warning generates, as an amount of rotation of the motor shaft.
	Overvoltage warning	Sets the voltage at which an overvoltage warning generates.
	Undervoltage warning	Sets the voltage at which an undervoltage warning generates.
	Overheat warning	Sets the temperature at which an overheat warning generates.
	Overload warning	Sets the condition under which an overload warning generates.
	Overspeed warning	Sets the speed at which an overspeed warning generates.
Descriptions of warnings	Excessive position deviation	<ul style="list-style-type: none"> The deviation between the command position and actual position at the motor output shaft exceeded the value set in the excessive position deviation warning parameter. (Initial value: 9 rev) The load is large or the acceleration/deceleration time is short.
	Overheat	The internal temperature of the driver exceeded the value set in the overheat warning parameter. [Initial value: 80 °C (176 °F)]
	Overvoltage	<ul style="list-style-type: none"> The voltage of the main power supply exceeded the value set in the overvoltage warning parameter. (Initial value: 390 V) A large inertial load was stopped abruptly, or up/down operation was performed without connecting a regeneration resistor.
	Main power supply	The S-ON input was turned ON when the main power was cut off.
	Undervoltage	<ul style="list-style-type: none"> The DC voltage of the main power supply became lower than the value set in the undervoltage warning parameter. (Initial value: 125 V) The main power was cut off momentarily or the voltage became low.
	Low battery voltage	The battery discharged and its voltage dropped to 3.2 V or below.
	Overload	<ul style="list-style-type: none"> The generated torque exceeded the value set in the overload warning parameter. (Initial value: 90 %) The load is large or the acceleration/deceleration time is short.
	Overspeed	The detected motor speed exceeded the value set in the overspeed warning parameter. (Initial value: 5,800 r/min)
	Absolute position loss	The battery or encoder was disconnected.
Electronic gear setting error	The resolution set by the electronic gear and encoder output electronic gear became outside the specified range.	

Standard specification	Extended function	Parameter/operation data			
		OPX-2A screen display	Name	Setting range	Initial value
Available	Available	APP-1-02	Output signal selection 1	0: WNG output 1: MOVE output 2: MBC output	0
Not available	Available	APP-3-01	Excessive position deviation warning	1 to 1,000 [rev]	9
Not available	Available	APP-3-02	Overvoltage warning	320 to 400 [V]	390
Not available	Available	APP-3-03	Undervoltage warning	120 to 280 [V]	125
Not available	Available	APP-3-04	Overheat warning	40 to 85 [°C] (104 to 185 °F)	80
Not available	Available	APP-3-05	Overload warning	1 to 100 [%]	90
Not available	Available	APP-3-06	Overspeed warning	1 to 6,000 [r/min]	5,800
Available	Available	–	–	–	–
Available	Available	–	–	–	–
Available	Available	–	–	–	–
Available	Available	–	–	–	–
Available	Available	–	–	–	–
Available	Available	–	–	–	–
Available	Available	–	–	–	–
Available	Available	–	–	–	–
Available	Available	–	–	–	–
Available	Available	–	–	–	–

- Unauthorized reproduction or copying of all or part of this manual is prohibited.
If a new copy is required to replace an original manual that has been damaged or lost, please contact your nearest Oriental Motor sales office.
- Oriental Motor shall not be liable whatsoever for any problems relating to industrial property rights arising from use of any information, circuit, equipment or device provided or referenced in this manual.
- Characteristics, specifications and dimensions are subject to change without notice.
- While we make every effort to offer accurate information in the manual, we welcome your input. Should you find unclear descriptions, errors or omissions, please contact your nearest Oriental Motor sales office.
- **Orientalmotor** is a registered trademark or trademark of Oriental Motor Co., Ltd., in Japan and other countries.
Other product names and company names mentioned in this manual may be registered trademarks or trademarks of their respective companies and are hereby acknowledged. The third-party products mentioned in this manual are recommended products, and references to their names shall not be construed as any form of performance guarantee. Oriental Motor is not liable whatsoever for the performance of these third-party products.

© Copyright ORIENTAL MOTOR CO., LTD. 2012

Published in December 2020

- Please contact your nearest Oriental Motor office for further information.

ORIENTAL MOTOR U.S.A. CORP.
Technical Support Tel:800-468-3982
8:30am EST to 5:00pm PST (M-F)
www.orientalmotor.com

ORIENTAL MOTOR (EUROPA) GmbH
Schiessstraße 44, 40549 Düsseldorf, Germany
Technical Support Tel:00 800/22 55 66 22
www.orientalmotor.de

ORIENTAL MOTOR (UK) LTD.
Tel:+44-1256347090
www.oriental-motor.co.uk

ORIENTAL MOTOR (FRANCE) SARL
Tel:+33-1 47 86 97 50
www.orientalmotor.fr

ORIENTAL MOTOR ITALIA s.r.l.
Tel:+39-02-93906347
www.orientalmotor.it

ORIENTAL MOTOR ASIA PACIFIC PTE. LTD.
Singapore
Tel:1800-842-0280
www.orientalmotor.com.sg

ORIENTAL MOTOR (MALAYSIA) SDN. BHD.
Tel:1800-806-161
www.orientalmotor.com.my

ORIENTAL MOTOR (THAILAND) CO., LTD.
Tel:1800-888-881
www.orientalmotor.co.th

ORIENTAL MOTOR (INDIA) PVT. LTD.
Tel:1800-120-1995 (For English)
1800-121-4149 (For Hindi)
www.orientalmotor.co.in

TAIWAN ORIENTAL MOTOR CO., LTD.
Tel:0800-060708
www.orientalmotor.com.tw

SHANGHAI ORIENTAL MOTOR CO., LTD.
Tel:400-820-6516
www.orientalmotor.com.cn

INA ORIENTAL MOTOR CO., LTD.
Korea
Tel:080-777-2042
www.inaom.co.kr

ORIENTAL MOTOR CO., LTD.
4-8-1 Higashiueno, Taito-ku, Tokyo
110-8536 Japan
Tel:+81-3-6744-0361
www.orientalmotor.co.jp