

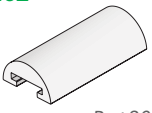













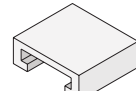
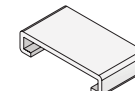
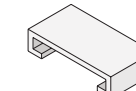
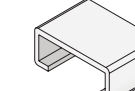
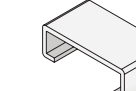
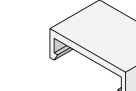
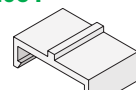























101 Pag 268	102 Pag 268	176 Pag 269	1074 Pag 269	103 Pag 270	104 Pag 270
179 Pag 271	175 Pag 271	1038 Pag 272	150 Pag 272	1058 Pag 272	174 Pag 272
1014 Pag 273	1015 Pag 273	1016 Pag 273	1017 Pag 273	1018 Pag 274	1019 Pag 274
1020 Pag 274	1021 Pag 275	1022 Pag 275	1023 Pag 275	1024 Pag 275	1025 Pag 276
1026 Pag 276	1027 Pag 276	1028 Pag 276	1046 Pag 276	1029 Pag 277	1030 Pag 277
1031 Pag 277	1032 Pag 277	1033 Pag 278	1034 Pag 278	1035 Pag 278	105 Pag 279
106 Pag 279	107 Pag 279	108 Pag 279	109 Pag 280	110 Pag 280	156 Pag 281
112 Pag 281	147 Pag 281	133 Pag 282	148 Pag 282	157 Pag 283	118 Pag 284

149  Pag 284	177  Pag 284	1059  Pag 285	178  Pag 285	111  Pag 285	1060  Pag 286
199  Pag 286	U-PROFILE  Pag 287	U-PROFILE SV  Pag 287	180  Pag 288	181  Pag 288	1052  Pag 288
1000  Pag 289	1001  Pag 289	1002  Pag 289	1003  Pag 289	1004  Pag 289	1006  Pag 290
153  Pag 290	1007  Pag 291	1008  Pag 291	1009  Pag 291	1010  Pag 292	1011  Pag 292
1012  Pag 292	1013  Pag 292	1040  Pag 293	119  Pag 294	120  Pag 294	121  Pag 294
152  Pag 294	1067  Pag 294	122  Pag 295	123  Pag 295	140  Pag 295	146  Pag 295
124  Pag 296	143  Pag 296	141  Pag 296	142  Pag 296	125  Pag 297	144  Pag 297
184  Pag 297	145  Pag 297	130  Pag 298	188  Pag 298	131  Pag 298	199  Pag 298
151  Pag 299/300	170  Pag 301	168  Pag 301	169  Pag 301	1036  Pag 301	1037  Pag 301
167  Pag 302	171  Pag 302	172  Pag 302	173  Pag 302	192  Pag 302	1062  Pag 303
1068  Pag 303	1072  Pag 303	1073  Pag 303	163  Pag 304	160  Pag 304	161  Pag 304

Profiles

162  Pag 304	164  Pag 304	165  Pag 304	154  Pag 305	155  Pag 305	134  Pag 305
1041  Pag 306	1042  Pag 306	1043  Pag 306	1044  Pag 307	1045  Pag 307	1053  Pag 307
1054  Pag 307	135  Pag 308	136  Pag 308	137  Pag 309	117  Pag 310	1055  Pag 310
159  Pag 310	1063  Pag 311	1064  Pag 311	158  Pag 312	158  Pag 312	182  Pag 313
1065  Pag 313	189  Pag 314	189  Pag 314	193  Pag 315	187  Pag 315	1056  Pag 316
1057  Pag 316	186  Pag 317	1061  Pag 317	166  Pag 318	1039  Pag 318	183  Pag 318
113  Pag 319	113  Pag 319	114  Pag 319	116  Pag 320	116  Pag 320	115  Pag 320

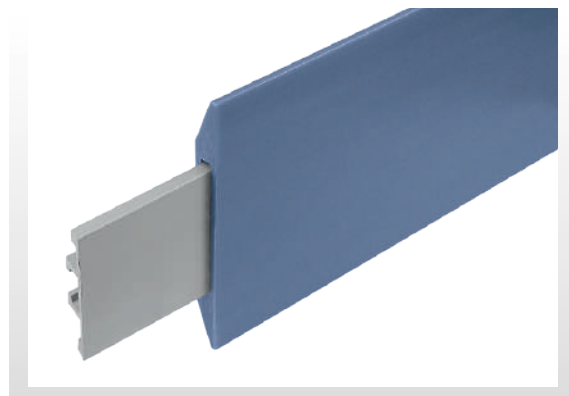
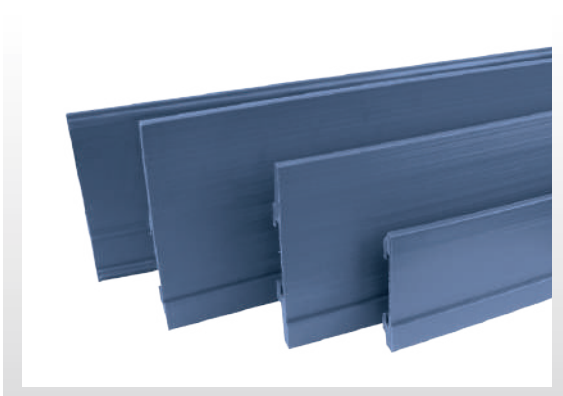

Material:

Polyethylene UHMW-PE with molecular density 5,600,000 g/mol
 Linear expansion coefficient: $1.1 \times 10^{-4} \text{ } ^\circ\text{F}^{-1}$ ($2 \times 10^{-4} \text{ } ^\circ\text{C}^{-1}$)
 Operating temperature: -40 to 176°F (-40 to +80°C)

101 Profilo "Z" Z-Profile / Z-Profil

On request available in white color

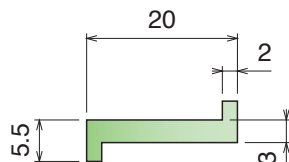
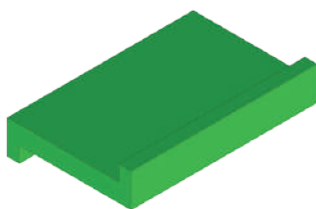

Part	Article-Nr.	Colour	Availability
101	10101	black	Stock item
101	10102	green	Stock item

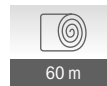

102 Profilo "Z" rinforzato Z-Profile reinforced / Z-Profil, verstärkt

On request available in white color

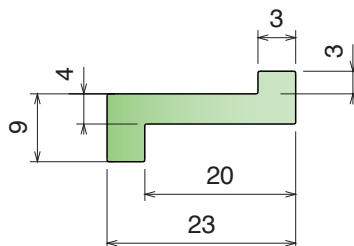
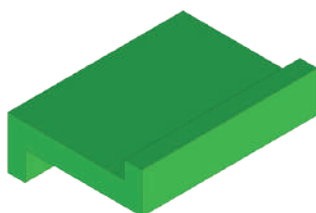

Part	Article-Nr.	Colour	Availability
102	10201	black	Stock item
102	10202	green	Stock item

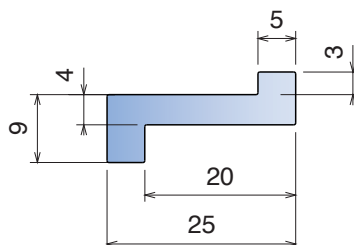
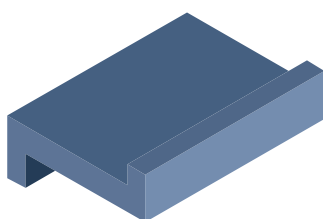
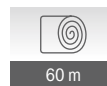

Part	Article-Nr.	Colour	Availability
102	10299B	BluLub	Stock item



Material:

Polyethylene UHMW-PE with molecular density 5,600,000 g/mol
 Linear expansion coefficient: $1.1 \times 10^{-4} \text{ } ^\circ\text{F}^{-1}$ ($2 \times 10^{-4} \text{ } ^\circ\text{C}^{-1}$)
 Operating temperature: -40 to 176°F (-40 to +80°C)

176 Profilo "Z" Z-Profile / Z-Profil

On request available in white color

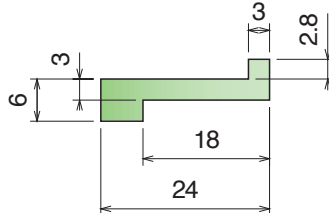
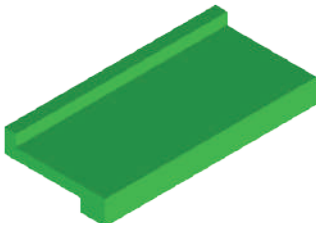

Part	Article-Nr.	Colour	Availability
176	17601	black	Stock item
176	17602	green	Stock item

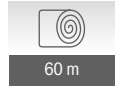

1074 Profilo "Z" Z-Profile / Z-Profil

On request available in white color

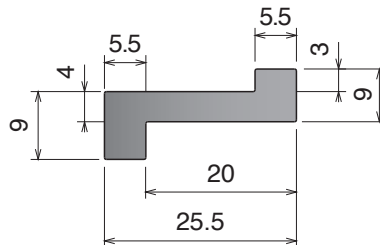
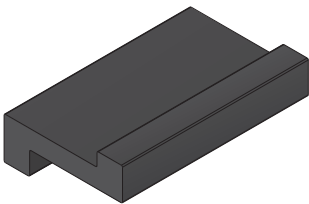

Part	Article-Nr.	Colour	Availability
1074	107401	black	Stock item



Material:

Polyethylene UHMW-PE with molecular density 5,600,000 g/mol
 Linear expansion coefficient: $1.1 \times 10^{-4} \text{ } ^\circ\text{F}^{-1}$ ($2 \times 10^{-4} \text{ } ^\circ\text{C}^{-1}$)
 Operating temperature: -40 to 176°F (-40 to +80°C)

103 Profilo Z-clip senza bordo Z-clip profile without nose / Z Profil ohne Nase

Fit on 2,5 to 3,5 mm

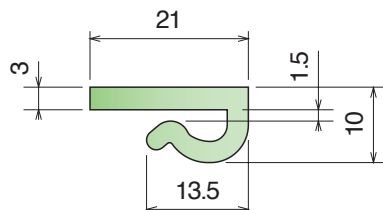
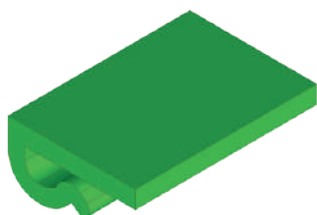

Part	Article-Nr.	Colour	Availability
103	10301	black	Stock item
103	10302	green	Stock item
103	10303	white	Stock item

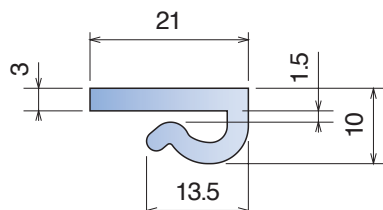
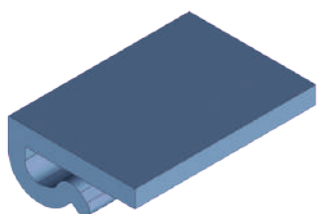

Part	Article-Nr.	Colour	Availability
103	10300B-30	BluLub	Stock item



104 Profilo Z-clip con bordo Z-clip profile with nose / Z Profil mit Nase

Fit on 2,5 to 3,5 mm

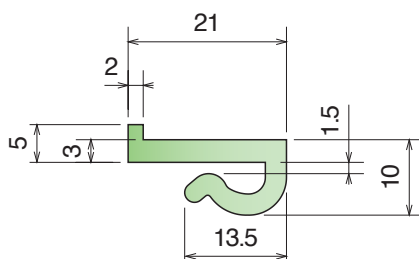
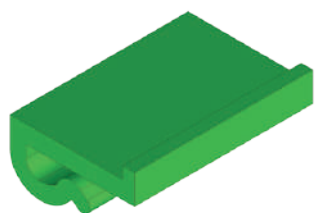

Part	Article-Nr.	Colour	Availability
104	10401	black	Stock item
104	10402	green	Stock item
104	10403	white	Stock item

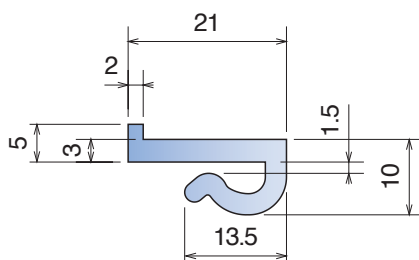
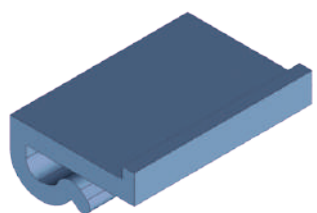

Part	Article-Nr.	Colour	Availability
104	10400B	BluLub	Stock item



Material:

Polyethylene UHMW-PE with molecular density 5,600,000 g/mol
 Linear expansion coefficient: $1.1 \times 10^{-4} \text{ } ^\circ\text{F}^{-1}$ ($2 \times 10^{-4} \text{ } ^\circ\text{C}^{-1}$)
 Operating temperature: -40 to 176°F (-40 to +80°C)

179

Profilo Z-clip con bordo
Z-clip profile with nose / Z Profil mit Nase

On request available in white color | Fit on 2,5 to 3,5 mm

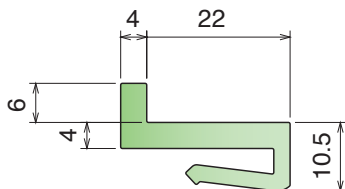
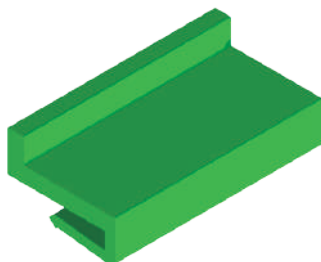

Part	Article-Nr.	L	Colour	Availability
179	17901C	3 m	black	Stock item
179	17901	6 m	black	On request
179	17902C	3 m	green	Stock item
179	17902	6 m	green	On request
179	17902-60	60 m	green	Stock item



175

Profilo "L"
L-Profile / L-Profil

On request available in white color

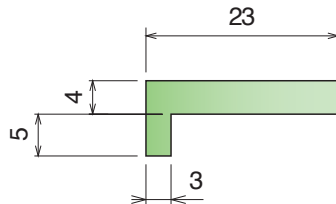
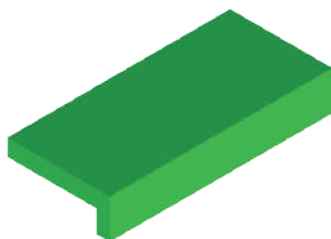

Part	Article-Nr.	Colour	Availability
175	17501	black	Stock item
175	17502	green	Stock item



1038-150-1058-174

Guide estruse / Extruded profiles / Extrudiertes Profil

Material:

Polyethylene UHMW-PE with molecular density 5,600,000 g/mol
 Linear expansion coefficient: $1.1 \times 10^{-4} \text{ } ^\circ\text{F}^{-1}$ ($2 \times 10^{-4} \text{ } ^\circ\text{C}^{-1}$)
 Operating temperature: -40 to 176°F (-40 to +80°C)

1038 Profilo "L" L-Profile / L-Profil

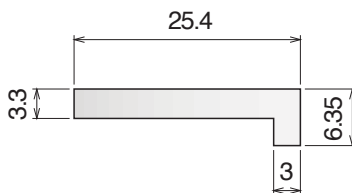
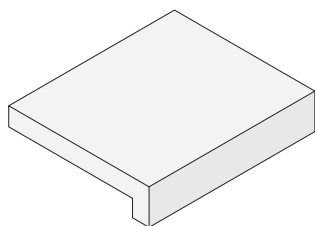

Part	Article-Nr.	L	Colour	Availability
1038	103803	60 m	white	On request

**NORTH
AMERICA
STANDARD**



150 Profilo "L" L-Profile / L-Profil

On request available in white color

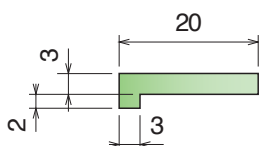
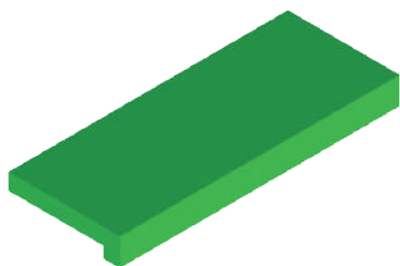

Part	Article-Nr.	Colour	Availability
150	15001	black	Stock item
150	15002	green	Stock item



1058 Profilo "L" L-Profile / L-Profil

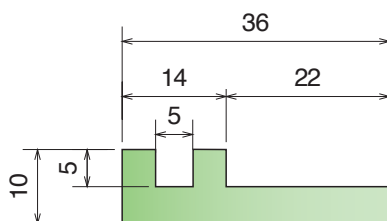
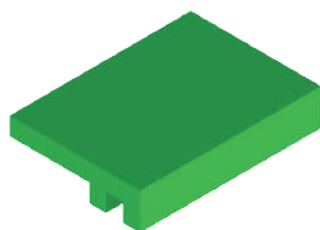

Part	Article-Nr.	L	Colour	Availability
1058	105801C	3 m	black	Stock item
1058	105801	6 m	black	On request
1058	105802C	3 m	green	Stock item
1058	105802	6 m	green	On request

174 Profilo "L" L-Profile / L-Profil

On request available in white color

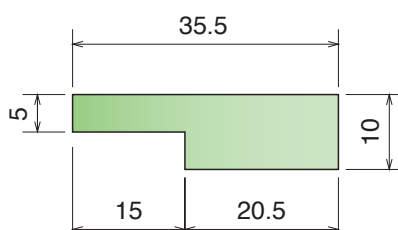
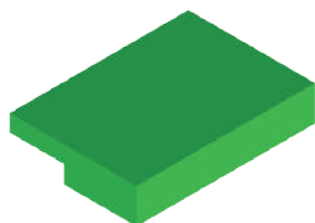

Part	Article-Nr.	L	Colour	Availability
174	17401C	3 m	black	Stock item
174	17401	6 m	black	On request
174	17402C	3 m	green	Stock item
174	17402	6 m	green	On request

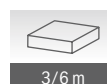
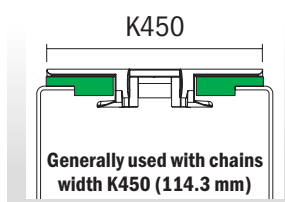

Material:

Polyethylene UHMW-PE with molecular density 5,600,000 g/mol
 Linear expansion coefficient: $1.1 \times 10^{-4} \text{ } ^\circ\text{F}^{-1}$ ($2 \times 10^{-4} \text{ } ^\circ\text{C}^{-1}$)
 Operating temperature: -40 to 176°F (-40 to +80°C)

1014-1015-1016-1017

Guide estruse / Extruded profiles / Extrudiertes Profil

1014 Profilo J-Leg 19.05 J-Leg Profile 19.05 / J Profil mit Nase 19.05

Fit on 3 mm

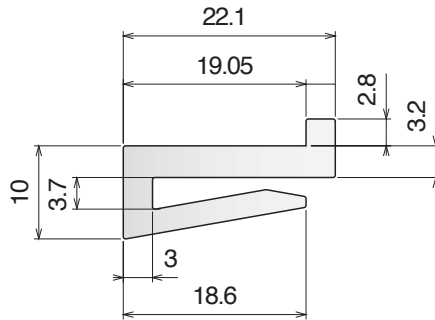
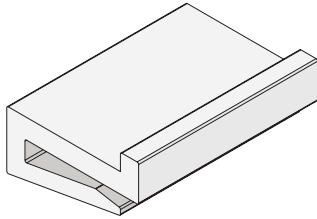

Part	Article-Nr.	L	Colour	Availability
1014	101403C	3 m	white	On request
1014	101403	6 m	white	On request

NORTH AMERICA STANDARD



1015 Profilo J-Leg 19.05 J-Leg Profile 19.05 / J Profil mit Nase 19.05

Fit on 3 mm

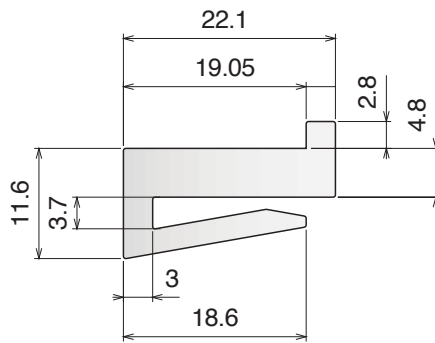
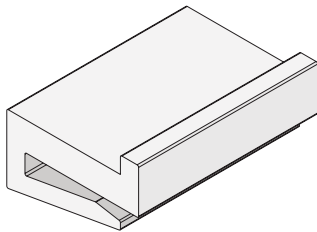

Part	Article-Nr.	L	Colour	Availability
1015	101503C	3 m	white	On request
1015	101503	6 m	white	On request

NORTH AMERICA STANDARD



1016 Profilo J-Leg 19.05 J-Leg Profile 19.05 / J Profil mit Nase 19.05

Fit on 3 mm

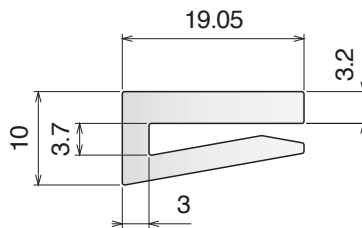
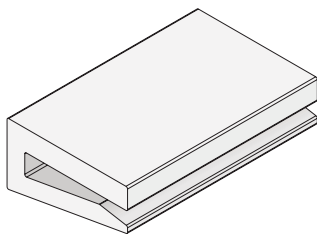

Part	Article-Nr.	L	Colour	Availability
1016	101603C	3 m	white	On request
1016	101603	6 m	white	On request
1016	101603-30	30 m	white	On request

NORTH AMERICA STANDARD



1017 Profilo J-Leg 25.4 J-Leg Profile 25.4 / J Profil 25.4

Fit on 3 mm

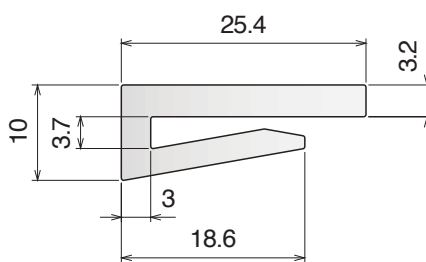
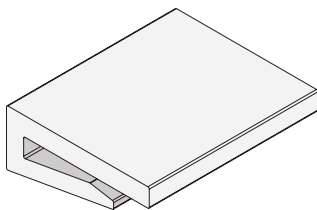

Part	Article-Nr.	L	Colour	Availability
1017	101703C	3 m	white	On request
1017	101703	6 m	white	On request
1017	101703-30	30 m	white	On request
1017	101703-75	75 m	white	On request

NORTH AMERICA STANDARD



Material:

Polyethylene UHMW-PE with molecular density 5,600,000 g/mol
 Linear expansion coefficient: $1.1 \times 10^{-4} \text{ } ^\circ\text{F}^{-1}$ ($2 \times 10^{-4} \text{ } ^\circ\text{C}^{-1}$)
 Operating temperature: -40 to 176°F (-40 to +80°C)

1018 Profilo J-Leg 25.4 J-Leg Profile 25.4 / J Profil 25.4

Fit on 3 mm

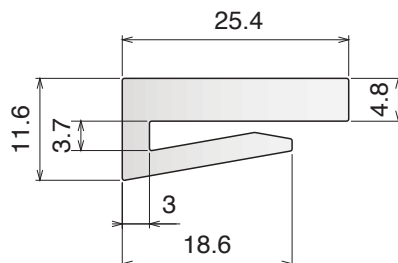
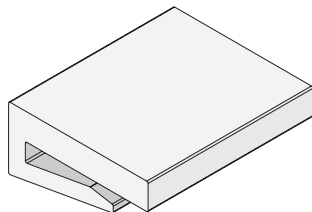

Part	Article-Nr.	L	Colour	Availability
1018	101803C	3 m	white	On request
1018	101803	6 m	white	On request

**NORTH
AMERICA
STANDARD**

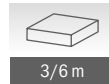

1019 Profilo J-Leg 25.4 J-Leg Profile 25.4 / J Profil 25.4

Fit on 3 mm

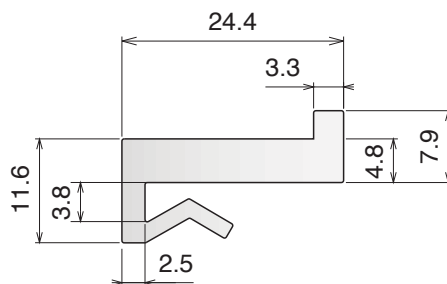
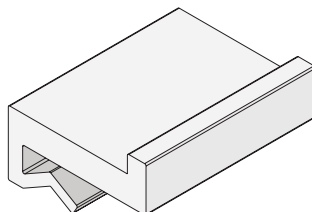

Part	Article-Nr.	L	Colour	Availability
1019	101903C	3 m	white	On request
1019	101903	6 m	white	On request

**NORTH
AMERICA
STANDARD**

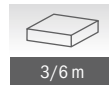

1020 Profilo J-Leg 25.4 J-Leg Profile 25.4 / J Profil 25.4

Fit on 3 mm

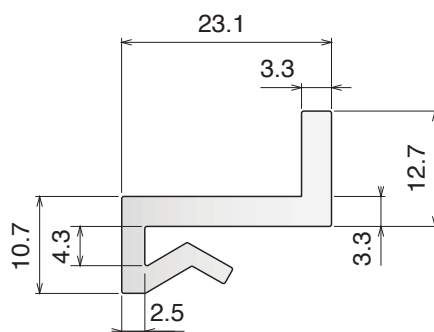
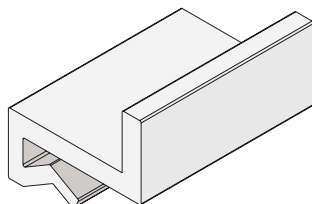

Part	Article-Nr.	L	Colour	Availability
1020	102003C	3 m	white	On request
1020	102003	6 m	white	On request

**NORTH
AMERICA
STANDARD**

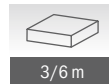

Material:

Polyethylene UHMW-PE with molecular density 5,600,000 g/mol
 Linear expansion coefficient: $1.1 \times 10^{-4} \text{ } ^\circ\text{F}^{-1}$ ($2 \times 10^{-4} \text{ } ^\circ\text{C}^{-1}$)
 Operating temperature: -40 to 176°F (-40 to +80°C)

1021-1022-1023-1024

Guide estruse / Extruded profiles / Extrudiertes Profil

1021 Profilo J-Leg 25.4 J-Leg Profile 25.4 / J Profil 25.4

Fit on 3 mm

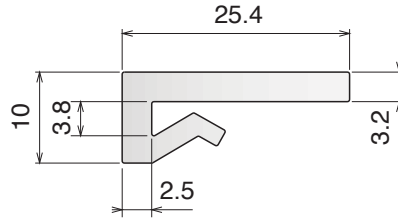
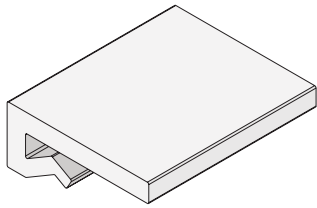

Part	Article-Nr.	L	Colour	Availability
1021	102103C	3 m	white	On request
1021	102103	6 m	white	On request
1021	102103-30	30 m	white	On request
1021	102103-75	75 m	white	On request

NORTH AMERICA STANDARD



1022 Profilo J-Leg 25.4 J-Leg Profile 25.4 / J Profil 25.4

Fit on 3 mm

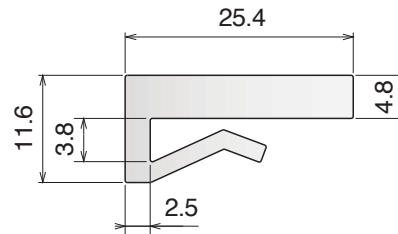
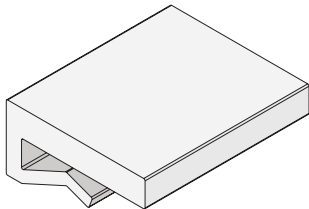

Part	Article-Nr.	L	Colour	Availability
1022	102203C	3 m	white	On request
1022	102203	6 m	white	On request
1022	102203-30	30 m	white	On request

NORTH AMERICA STANDARD



1023 Profilo J-Leg 25.4 J-Leg Profile 25.4 / J Profil 25.4

Fit on 3 mm

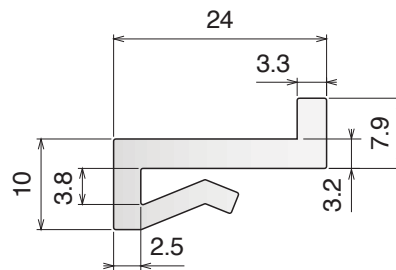
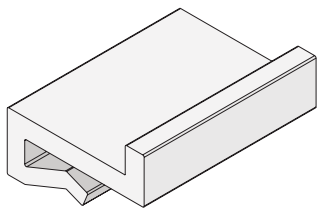

Part	Article-Nr.	L	Colour	Availability
1023	102303C	3 m	white	On request
1023	102303	6 m	white	On request

NORTH AMERICA STANDARD



1024 Profilo J-Leg 25.4 J-Leg Profile 25.4 / J Profil 25.4

Fit on 3 mm

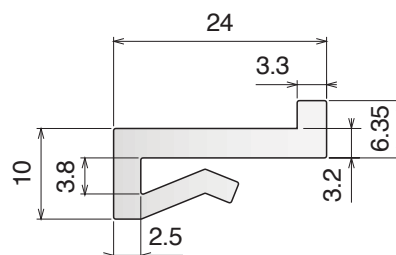
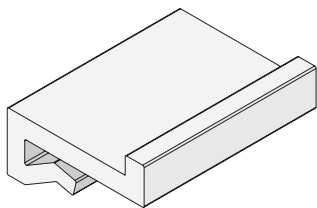

Part	Article-Nr.	L	Colour	Availability
1024	102403C	3 m	white	On request
1024	102403	6 m	white	On request
1024	102403-30	30 m	white	On request
1024	102402	6 m	green	On request

NORTH AMERICA STANDARD



Material:

Polyethylene UHMW-PE with molecular density 5,600,000 g/mol
 Linear expansion coefficient: $1.1 \times 10^{-4} \text{ } ^\circ\text{F}^{-1}$ ($2 \times 10^{-4} \text{ } ^\circ\text{C}^{-1}$)
 Operating temperature: -40 to 176°F (-40 to +80°C)

1025 Profilo J-Leg 38.1 J-Leg Profile 38.1 / J Profil 38.1

Fit on 3 mm

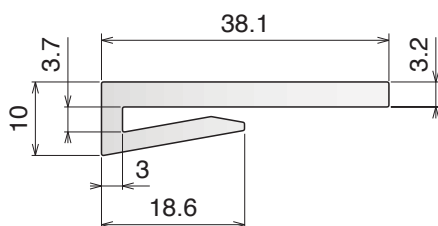
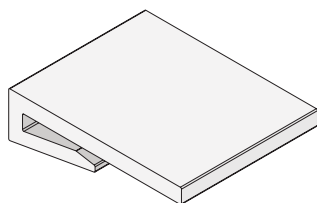

Part	Article-Nr.	L	Colour	Availability
1025	102503C	3 m	white	On request
1025	102503	6 m	white	On request
1025	102503-30	30 m	white	On request

NORTH AMERICA STANDARD



1026 Profilo J-Leg 38.1 J-Leg Profile 38.1 / J Profil 38.1

Fit on 3 mm

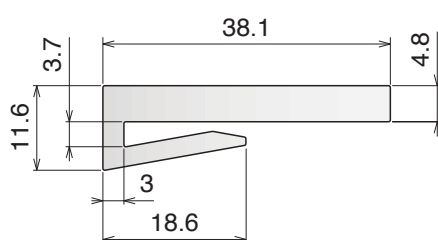
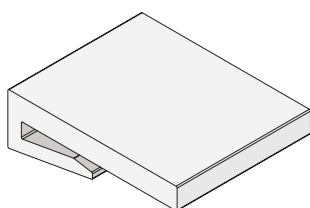

Part	Article-Nr.	L	Colour	Availability
1026	102603C	3 m	white	On request
1026	102603	6 m	white	On request

NORTH AMERICA STANDARD



1027 Profilo J-Leg 38.1 J-Leg Profile 38.1 / J Profil mit Nase 38.1

Fit on 3 mm

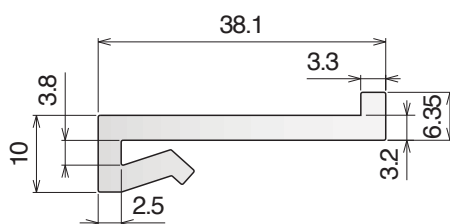
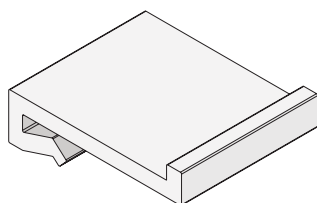

Part	Article-Nr.	L	Colour	Availability
1027	102703C	3 m	white	On request
1027	102703	6 m	white	On request

NORTH AMERICA STANDARD



1028 Profilo J-Leg 38.1 J-Leg Profile 38.1 / J Profil 38.1

Fit on 3 mm

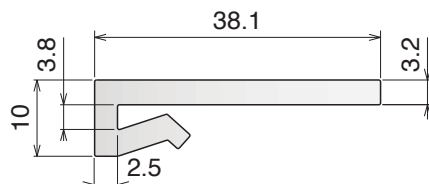
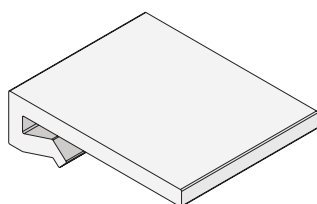

Part	Article-Nr.	L	Colour	Availability
1028	102803C	3 m	white	On request
1028	102803	6 m	white	On request

NORTH AMERICA STANDARD



1046 Profilo J-Leg 40 J-Leg Profile 40 / J Profil 40

Fit on 3 mm

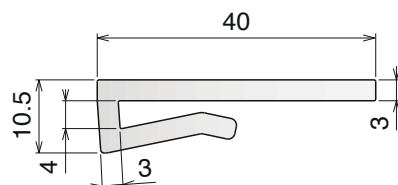
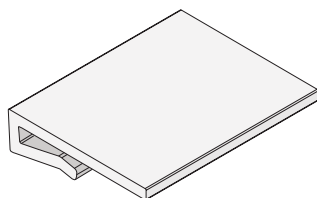

Part	Article-Nr.	L	Colour	Availability
1046	104602C	3 m	green	On request
1046	104603C	3 m	white	On request
1046	104602-30	30 m	green	On request



Material:

Polyethylene UHMW-PE with molecular density 5,600,000 g/mol
 Linear expansion coefficient: $1.1 \times 10^{-4} \text{ } ^\circ\text{F}^{-1}$ ($2 \times 10^{-4} \text{ } ^\circ\text{C}^{-1}$)
 Operating temperature: -40 to 176°F (-40 to +80°C)

1029-1030-1031-1032

Guide estruse / Extruded profiles / Extrudiertes Profil

1029

Profilo J-Leg 50.8
 J-Leg Profile 50.8 / J Profil 50.8

Fit on 3 mm

Part	Article-Nr.	L	Colour	Availability
1029	102903C	3 m	white	On request
1029	102903	6 m	white	On request

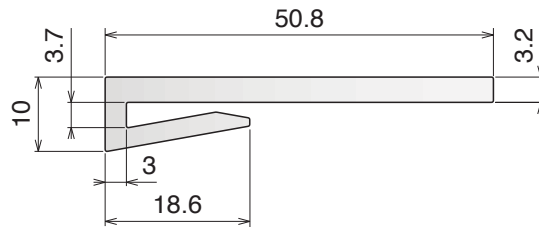
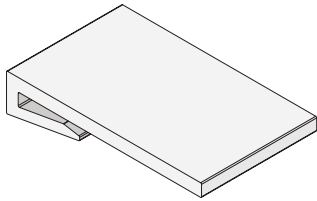

**NORTH
 AMERICA
 STANDARD**



1030

Profilo J-Leg 50.8
 J-Leg Profile 50.8 / J Profil 50.8

Fit on 3 mm

Part	Article-Nr.	L	Colour	Availability
1030	103003C	3 m	white	On request
1030	103003	6 m	white	On request

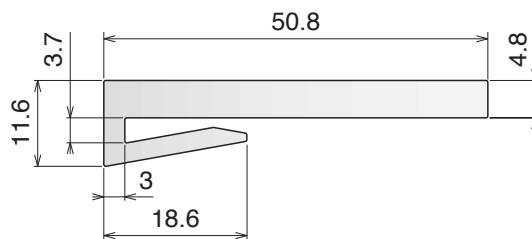
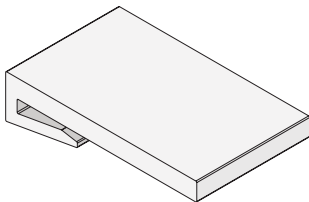

**NORTH
 AMERICA
 STANDARD**



1031

Profilo J-Leg 50.8
 J-Leg Profile 50.8 / J Profil 50.8

Fit on 3 mm

Part	Article-Nr.	L	Colour	Availability
1031	103103C	3 m	white	On request
1031	103103	6 m	white	On request

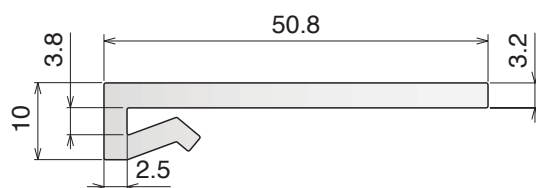
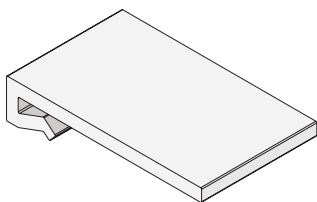

**NORTH
 AMERICA
 STANDARD**



1032

Profilo J-Leg 50.8
 J-Leg Profile 50.8 / J Profil 50.8

Fit on 3 mm

Part	Article-Nr.	L	Colour	Availability
1032	103203C	3 m	white	On request
1032	103203	6 m	white	On request

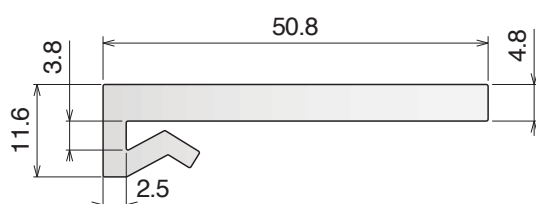
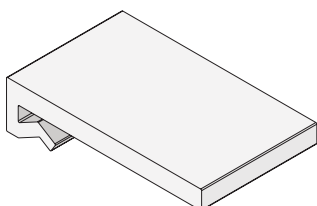

**NORTH
 AMERICA
 STANDARD**



1033-1034-1035

Guide estruse / Extruded profiles / Extrudiertes Profil

Material:

Polyethylene UHMW-PE with molecular density 5,600,000 g/mol
 Linear expansion coefficient: $1.1 \times 10^{-4} \text{ } ^\circ\text{F}^{-1}$ ($2 \times 10^{-4} \text{ } ^\circ\text{C}^{-1}$)
 Operating temperature: -40 to 176°F (-40 to +80°C)

1033 Profilo J-Leg 76.2 J-Leg Profile 76.2 / J Profil 76.2

Fit on 3 mm

Part	Article-Nr.	L	Colour	Availability
1033	103303C	3 m	white	On request
1033	103303	6 m	white	On request

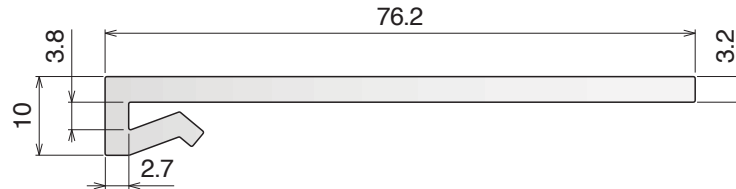
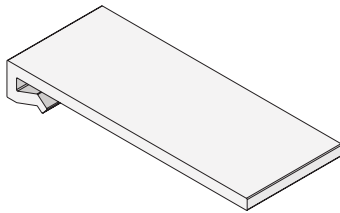

**NORTH
AMERICA
STANDARD**



1034 Profilo J-Leg 76.2 J-Leg Profile 76.2 / J Profil 76.2

Fit on 3 mm

Part	Article-Nr.	L	Colour	Availability
1034	103403C	3 m	white	On request
1034	103403	6 m	white	On request

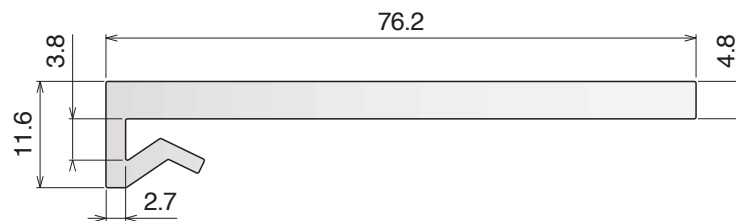
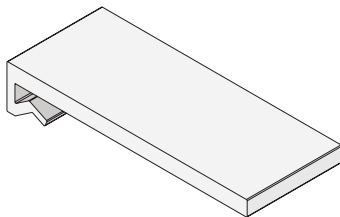

**NORTH
AMERICA
STANDARD**



1035 Profilo J-Leg 73 J-Leg Profile 73 / J Profil 73

Fit on 3 mm

Part	Article-Nr.	L	Colour	Availability
1035	103503C	3 m	white	On request
1035	103503	6 m	white	On request

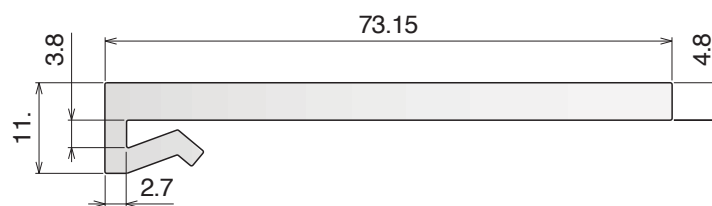
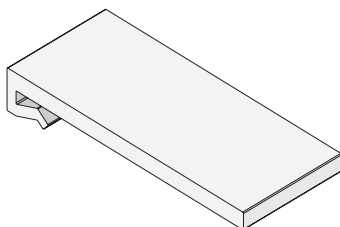

**NORTH
AMERICA
STANDARD**



Material:

Polyethylene UHMW-PE with molecular density 5,600,000 g/mol
 Linear expansion coefficient: $1.1 \times 10^{-4} \text{ } ^\circ\text{F}^{-1}$ ($2 \times 10^{-4} \text{ } ^\circ\text{C}^{-1}$)
 Operating temperature: -40 to 176°F (-40 to +80°C)

105 Profilo piatto Flat profile / Flachprofil

On request available in white color

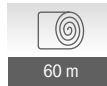
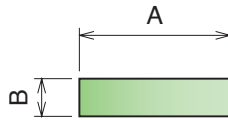
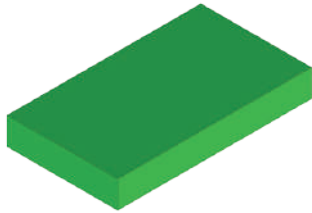

Part	Article-Nr.	A	B	Colour	Availability
105	10501	20	3	black	Stock item
105	10502	20	3	green	Stock item
105	10503	20	5	black	Stock item
105	10504	20	5	green	Stock item
105	10595	25	3	green	Stock item
105	10592	30	3	green	On request
105	10594	30	5	green	On request
105	10596	40	3	green	Stock item
105	10597	50	3	green	On request
105	10505	60	3	black	Stock item
105	10506	60	3	green	Stock item
105	10507	70	3	black	Stock item
105	10508	70	3	green	Stock item
105	10509	100	3	black	On request
105	10510	100	3	green	Stock item

106 Profilo guida catena Flat profile with nose / Flachprofil mit Nase

On request available in white color

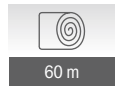
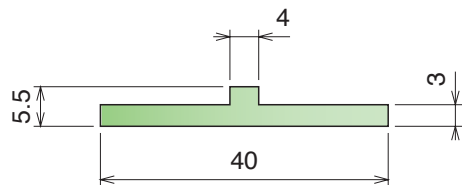
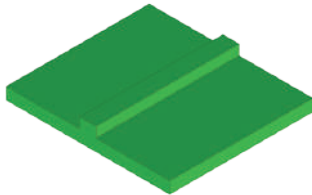

Part	Article-Nr.	Colour	Availability
106	10601	black	Stock item
106	10602	green	Stock item

107 Profilo guida catena Wear strip / Rückführleiste

On request available in white color

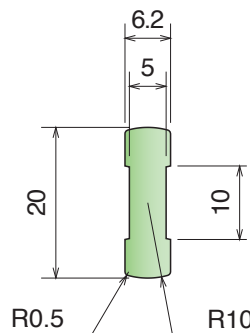
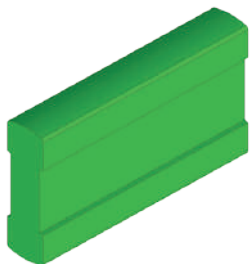

Supports Available:
PART 230-231
Pag 332

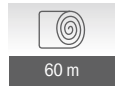

Part	Article-Nr.	Colour	Availability
107	10701	black	Stock item
107	10702	green	Stock item

108 Profilo T T-profile / T-Profil

On request available in white color | Fit on 4 mm

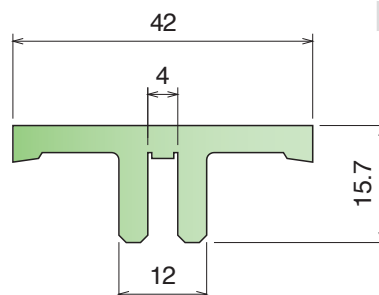
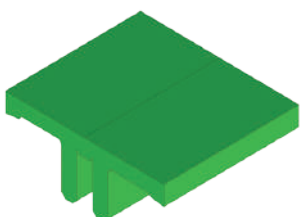

Part	Article-Nr.	L	Colour	Availability
108	10801C	3 m	black	Stock item
108	10801	6 m	black	On request
108	10802C	3 m	green	Stock item
108	10802	6 m	green	On request

Material:

Polyethylene UHMW-PE with molecular density 5,600,000 g/mol
 Linear expansion coefficient: $1.1 \times 10^{-4} \text{ } ^\circ\text{F}^{-1}$ ($2 \times 10^{-4} \text{ } ^\circ\text{C}^{-1}$)
 Operating temperature: -40 to 176°F (-40 to +80°C)

109 Profilo clip-on guida catena Flat clip-on wear strip / U-Profil Clip-on

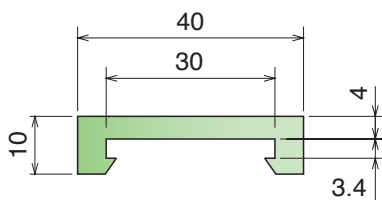
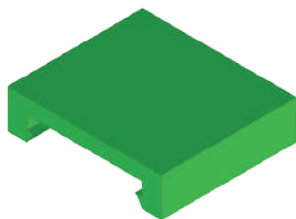

Part	Article-Nr.	L	Colour	Availability
109	10901C	3 m	black	Stock item
109	10901	6 m	black	On request
109	10902C	3 m	green	Stock item
109	10902	6 m	green	On request
109	10903C	3 m	white	Stock item
109	10903	6 m	white	Stock item

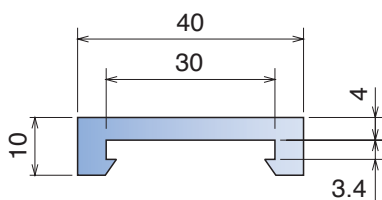
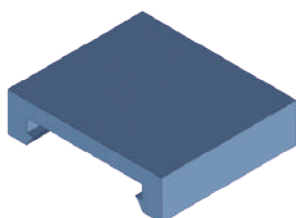
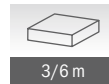

Part	Article-Nr.	L	Colour	Availability
109	10901BC	3 m	BluLub	Stock item
109	10901B	6 m	BluLub	On request
109	10901B-30	30 m	BluLub	On request



110 Profilo clip-on guida catena con bordo Flat clip-on wear strip with nose / U-Profil Clip-on mit Nase

On request available in white color

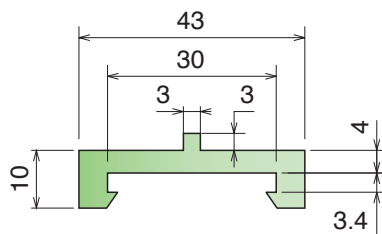
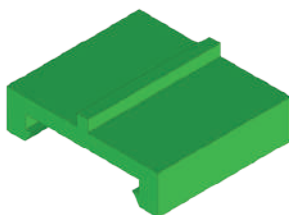

Part	Article-Nr.	L	Colour	Availability
110	11001C	3 m	black	Stock item
110	11001	6 m	black	On request
110	11002C	3 m	green	Stock item
110	11002	6 m	green	On request

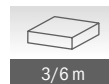

156 Profilo clip-on guida tappeto Clip-on wear strip for belt / Clip-on m. Seitenführung

On request available in white color

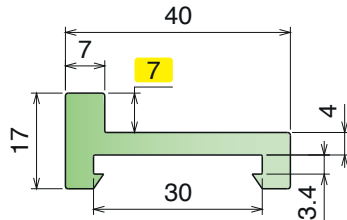
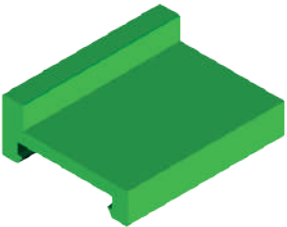
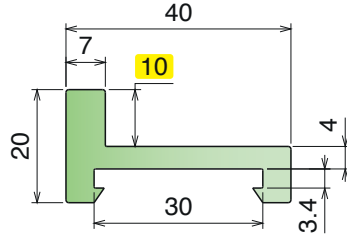
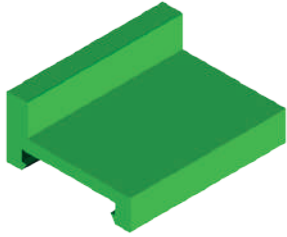

Part	Article-Nr.	L	Colour	Availability
156	15601C	3 m	black	Stock item
156	15601	6 m	black	On request
156	15602C	3 m	green	Stock item
156	15602	6 m	green	On request



3/6 m

Part	Article-Nr.	L	Colour	Availability
156	15699C	3 m	green	On request



3 m

112 Profilo Profile / Profil

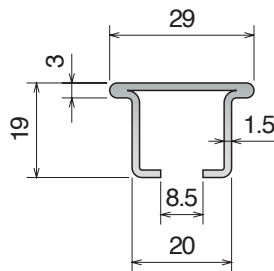
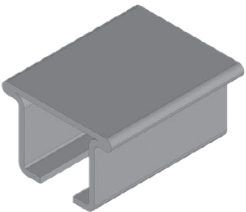

Part	Article-Nr.	L	Material	Availability
112	11201C	3 m	AISI 304	Stock item
112	11201	6 m	AISI 304	On request
112	11202C	3 m	AISI 430	Stock item
112	11202	6 m	AISI 430	On request

Assembly with accessories at pages 285-286



3/6 m

147 Profilo in alluminio Aluminum profile / Aluminium-Profil

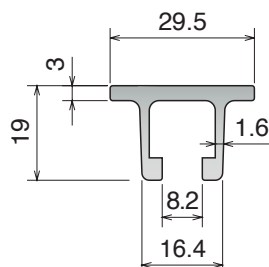
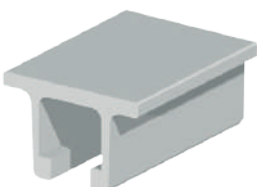

Part	Article-Nr.	L	Material	Availability
147	14701C	3 m	Aluminium	Stock item
147	14701	6 m	Aluminium	On request



3/6 m

Material:

Polyethylene UHMW-PE with molecular density 5,600,000 g/mol
 Linear expansion coefficient: $1.1 \times 10^{-4} \text{ } ^\circ\text{F}^{-1}$ ($2 \times 10^{-4} \text{ } ^\circ\text{C}^{-1}$)
 Operating temperature: -40 to 176°F (-40 to +80°C)

133 Profilo assemblato clip-on Profile assembled clip-on / Profile montiert clip-on

On request available in white color

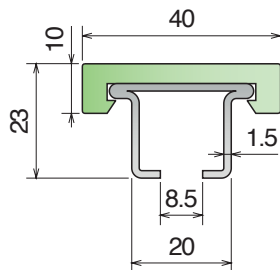
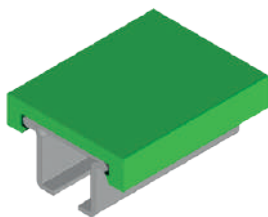

Part	Article-Nr.	L	Material	Colour	Availability
133	13301C	3 m	AISI 304	green	Stock item
133	13301	6 m	AISI 304	green	On request
133	13302C	3 m	AISI 430	green	Stock item
133	13302	6 m	AISI 430	green	On request
133	13303C	3 m	AISI 304	black	Stock item
133	13303	6 m	AISI 304	black	On request
133	13304C	3 m	AISI 430	black	Stock item
133	13304	6 m	AISI 430	black	On request
133	13305BC	3 m	AISI 304	BluLub	Stock item
133	13305B	6 m	AISI 304	BluLub	On request
133	13306BC	3 m	AISI 430	BluLub	Stock item
133	13306B	6 m	AISI 430	BluLub	On request

Assembly with accessories at pages 319-320



3/6 m

148 Profilo assemblato clip-on Profile assembled clip-on / Profile montiert clip-on

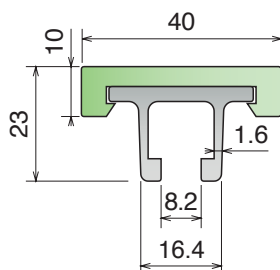
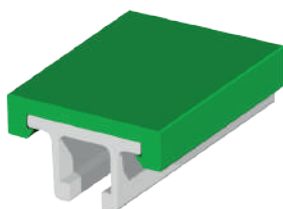

Part	Article-Nr.	L	Material	Colour	Availability
148	14801C	3 m	Aluminium	green	Stock item
148	14801	6 m	Aluminium	green	On request
148	14801BC	3 m	Aluminium	BluLub	Stock item
148	14801B	6 m	Aluminium	BluLub	On request
148	14802C	3 m	Aluminium	black	Stock item
148	14802	6 m	Aluminium	black	On request
148	14803C	3 m	Aluminium	white	Stock item



3/6 m

Material:

Polyethylene UHMW-PE with molecular density 5,600,000 g/mol
 Linear expansion coefficient: $1.1 \times 10^{-4} \text{ } ^\circ\text{F}^{-1}$ ($2 \times 10^{-4} \text{ } ^\circ\text{C}^{-1}$)
 Operating temperature: -40 to 176°F (-40 to +80°C)

157

Profilo guida tappeto assemblato

Wear strip assembled for belt / Gleitleiste für mattenketten kpl montiert

On request available in white color

Part	Article-Nr.	L	Material	Colour	Availability
157	15701C	3 m	AISI 304	green	Stock item
157	15701	6 m	AISI 304	green	On request
157	15702C	3 m	AISI 430	green	Stock item
157	15702	6 m	AISI 430	green	On request

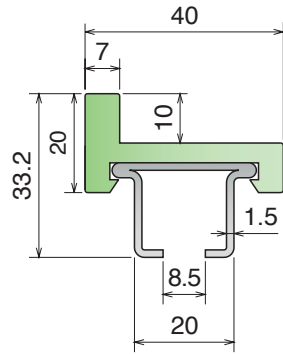
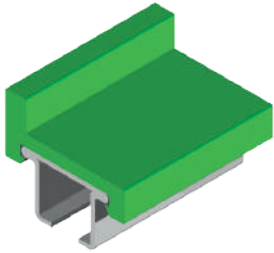

Assembly with accessories at pages 319-320

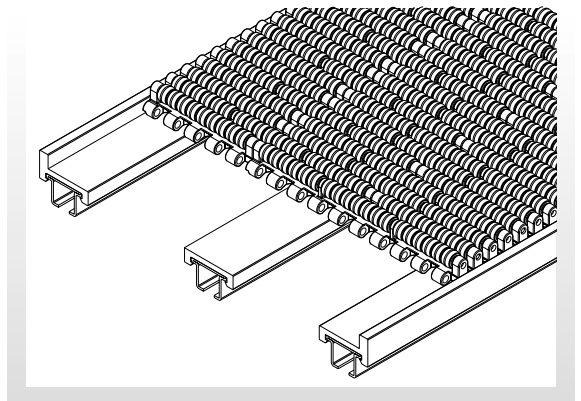

Part	Article-Nr.	L	Material	Colour	Availability
157	15799C	3 m	AISI 304	green	On request

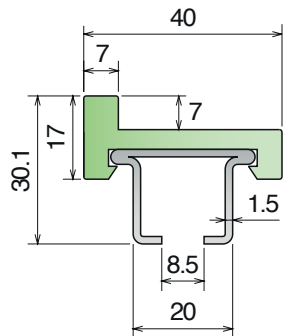
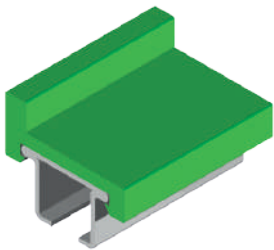

Material:

Polyethylene UHMW-PE with molecular density 5,600,000 g/mol
 Linear expansion coefficient: $1.1 \times 10^{-4} \text{ } ^\circ\text{F}^{-1}$ ($2 \times 10^{-4} \text{ } ^\circ\text{C}^{-1}$)
 Operating temperature: -40 to 176°F (-40 to +80°C)

118 Profilo Delta D-Profile / D-Profil

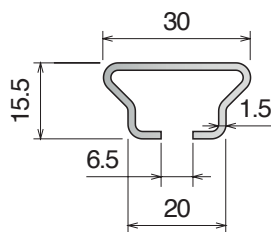
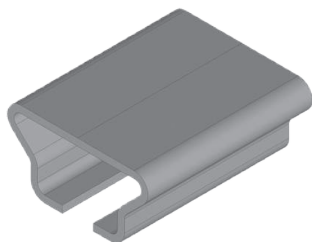

Part	Article-Nr.	L	Material	Availability
118	11801C	3 m	AISI 304	Stock item
118	11801	6 m	AISI 304	On request
118	11802C	3 m	AISI 430	Stock item
118	11802	6 m	AISI 430	On request

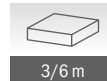

149 Profilo ad "U" con bordo U-profile with nose / U-Profil mit Nase

On request available in white color

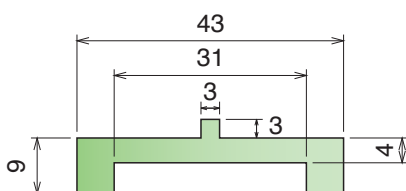
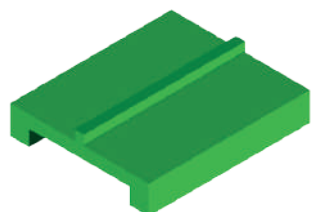

Part	Article-Nr.	L	Colour	Availability
149	14950C	3 m	black	Stock item
149	14950	6 m	black	On request
149	14952C	3 m	green	Stock item
149	14952	6 m	green	On request

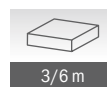

177 Profilo ad "U" U-profile / U-Profil

On request available in white color

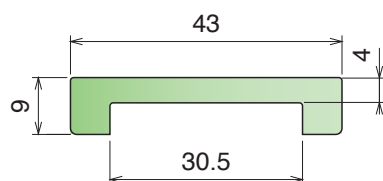
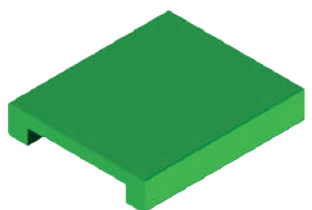

Part	Article-Nr.	L	Colour	Availability
177	17701C	3 m	black	Stock item
177	17701	6 m	black	On request
177	17702C	3 m	green	Stock item
177	17702	6 m	green	On request
177	17701BC	3 m	BluLub	Stock item
177	17701B	6 m	BluLub	On request
177	17702-30	30 m	green	On request

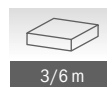

Material:

Polyethylene UHMW-PE with molecular density 5,600,000 g/mol
 Linear expansion coefficient: $1.1 \times 10^{-4} \text{ } ^\circ\text{F}^{-1}$ ($2 \times 10^{-4} \text{ } ^\circ\text{C}^{-1}$)
 Operating temperature: -40 to 176°F (-40 to +80°C)

1059 Profilo ad "U" U-profile / U-Profil

On request available in white color

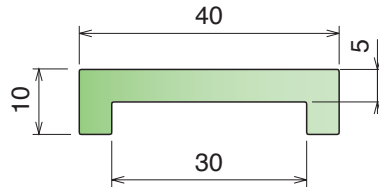
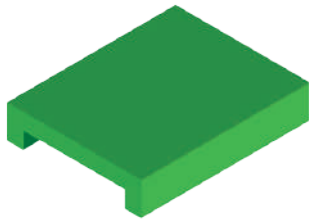

Part	Article-Nr.	L	Colour	Availability
1059	105901C	3 m	black	Stock item
1059	105901	6 m	black	On request
1059	105902C	3 m	green	Stock item
1059	105902	6 m	green	On request
1059	105901BC	3 m	BluLub	Stock item
1059	105901B	6 m	BluLub	On request

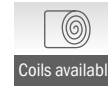

178 Profilo ad "U" U-profile / U-Profil

On request available in white color

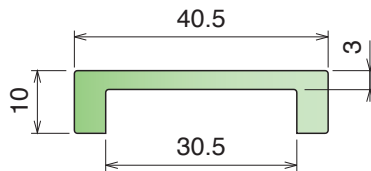
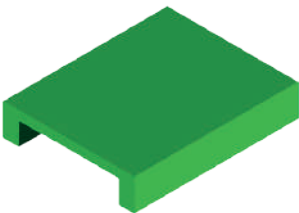

Part	Article-Nr.	L	Colour	Availability
178	17801C	3 m	black	Stock item
178	17801	6 m	black	On request
178	17802C	3 m	green	Stock item
178	17802	6 m	green	On request
178	17801BC	3 m	BluLub	Stock item
178	17801B	6 m	BluLub	On request

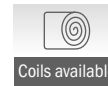

111 Profilo ad "U" U-profile / U-Profil

On request available in white color

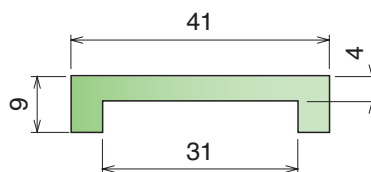
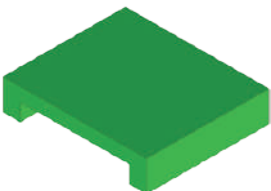

Part	Article-Nr.	L	Colour	Availability
111	11101C	3 m	black	Stock item
111	11101	6 m	black	On request
111	11102C	3 m	green	Stock item
111	11102	6 m	green	On request
111	11101-60	60 m	black	On request
111	11102-60	60 m	green	On request
111	11101BC	3 m	BluLub	Stock item
111	11101B	6 m	BluLub	On request



Material:

Polyethylene UHMW-PE with molecular density 5,600,000 g/mol
 Linear expansion coefficient: $1.1 \times 10^{-4} \text{ } ^\circ\text{F}^{-1}$ ($2 \times 10^{-4} \text{ } ^\circ\text{C}^{-1}$)
 Operating temperature: -40 to 176°F (-40 to +80°C)

1060 Profilo ad "U" U-profile / U-Profil

On request available in white color

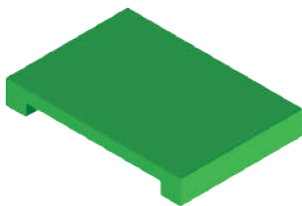

Part	Article-Nr.	L	Colour	Availability
1060	106001C	3 m	black	Stock item
1060	106001	6 m	black	On request
1060	106002C	3 m	green	Stock item
1060	106002	6 m	green	On request



Coils available



3/6 m

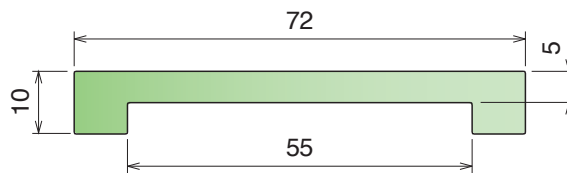

199 Profilo ad "U" U-profile / U-Profil

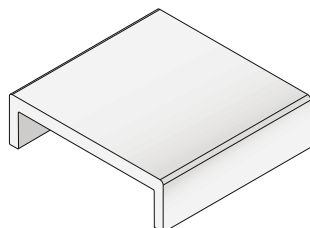

Part	Article-Nr.	L	Colour	Availability
199	19976	6 m	white	On request



6 m

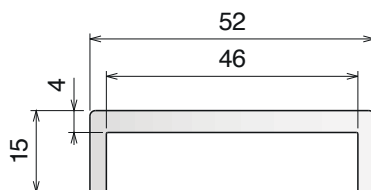

Material:

Polyethylene UHMW-PE with molecular density 5,600,000 g/mol
 Linear expansion coefficient: $1.1 \times 10^{-4} \text{ } ^\circ\text{F}^{-1}$ ($2 \times 10^{-4} \text{ } ^\circ\text{C}^{-1}$)
 Operating temperature: -40 to 176°F (-40 to +80°C)

U-Profile

Profilo ad "U" 42 mm
 U-profile 42 mm / U-Profil 42 mm

On request available in white color

Part	Article-Nr.	L	Colour	Availability
199	19944B-30	30 m	BluLub	On request

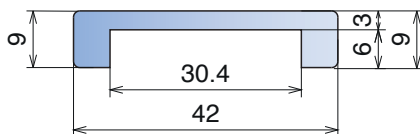
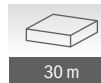
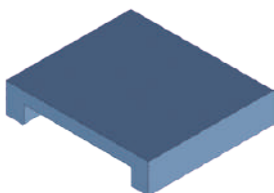

Staggered version

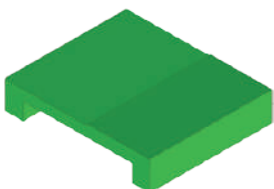

Part	Article-Nr.	L	Colour	Availability
199	19945-30	30 m	black	Stock item
199	19945B-30	30 m	BluLub	Stock item
199	19946-30	30 m	green	Stock item

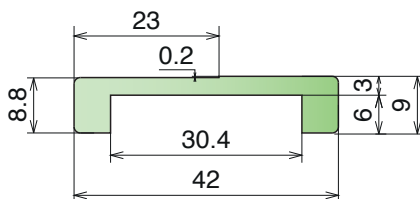
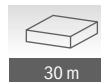

U-Profile (Staggered version)

This profile has been designed for pressure-less combiners and it is used to ensure the best side-transfer of the bottles across the chains. It is not recommended to connect these profiles and, during the installation, the correct orientation must be carefully maintained.

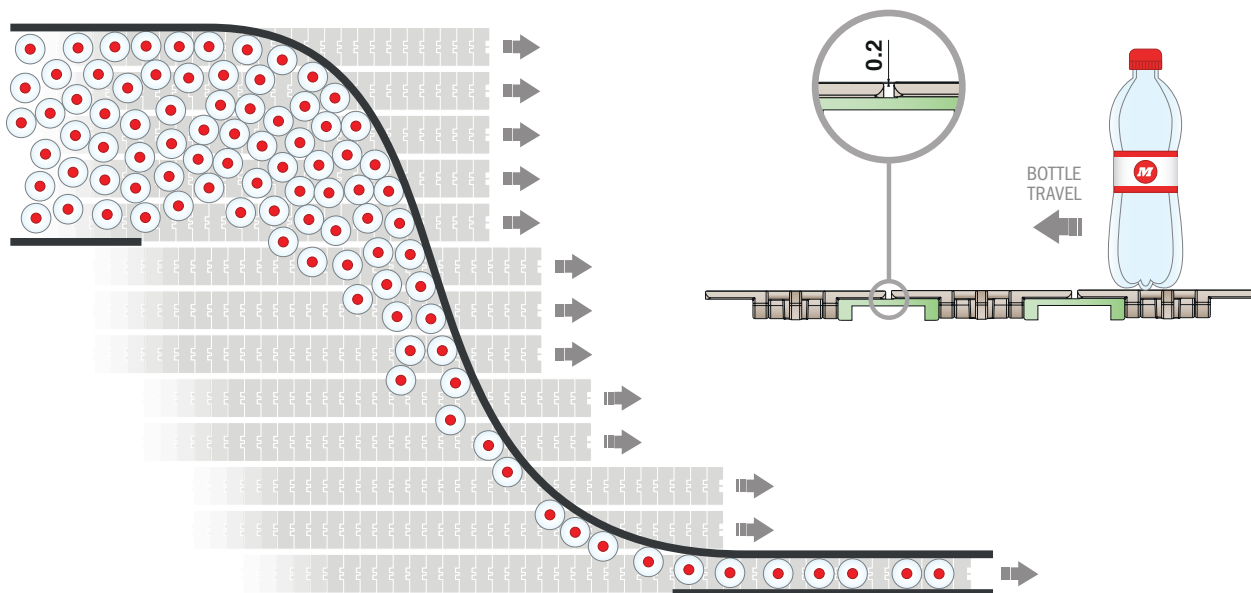

Material:

Polyethylene UHMW-PE with molecular density 5,600,000 g/mol
 Linear expansion coefficient: $1.1 \times 10^{-4} \text{ } ^\circ\text{F}^{-1}$ ($2 \times 10^{-4} \text{ } ^\circ\text{C}^{-1}$)
 Operating temperature: -40 to 176°F (-40 to +80°C)

180 Copri profilo Bar cover / Abdeckprofil

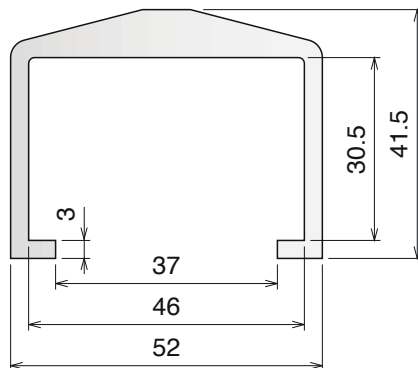
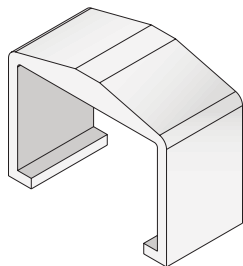

Part	Article-Nr.	L	Colour	Availability
180	18003C	3 m	white	Stock item
180	18003	6 m	white	On request

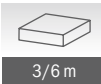

3/6 m

181 Copri profilo 25.4x25.4 Bar cover 25.4x25.4 / Abdeckprofil 25.4x25.4

Fit on 25.4x25.4 mm

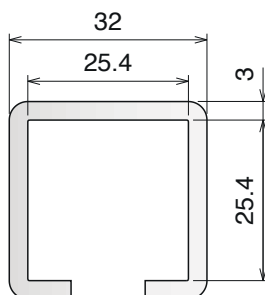
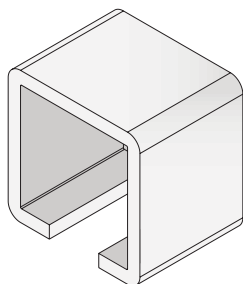

Part	Article-Nr.	L	Colour	Availability
181	18103C	3 m	white	Stock item
181	18103	6 m	white	On request



3/6 m

1052 Copri profilo 38.1x50.8 Bar cover 38.1x50.8 / Abdeckprofil 38.1x50.8

Fit on 38.1x50.8 mm

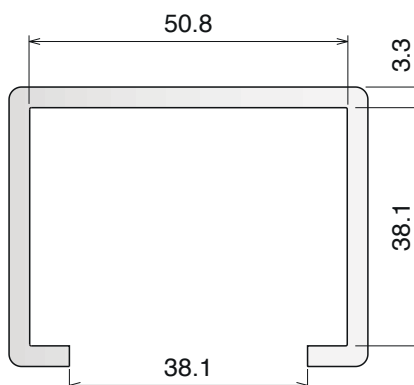
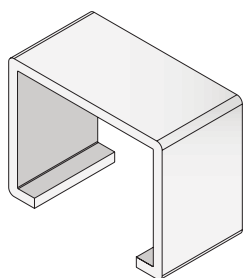

Part	Article-Nr.	L	Colour	Availability
1052	105203C	3 m	white	Stock item
1052	105203	6 m	white	On request



3/6 m

Material:

Polyethylene UHMW-PE with molecular density 5,600,000 g/mol
 Linear expansion coefficient: $1.1 \times 10^{-4} \text{ } ^\circ\text{F}^{-1}$ ($2 \times 10^{-4} \text{ } ^\circ\text{C}^{-1}$)
 Operating temperature: -40 to 176°F (-40 to +80°C)

1000-1001-1002-1003-1004

Guide estruse / Extruded profiles / Extrudiertes Profil

1000 Copri profilo 1.5 mm Bar cap 1.5 mm / Abdeckprofil 1.5 mm

Fit on 1.5 mm

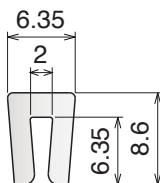
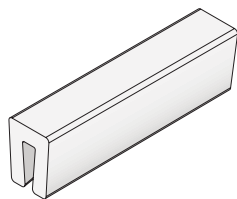

Part	Article-Nr.	L	Colour	Availability
1000	100003-30	30 m	white	On request



1001 Copri profilo 1.5 mm Bar cap 1.5 mm / Abdeckprofil 1.5 mm

Fit on 1.5 mm

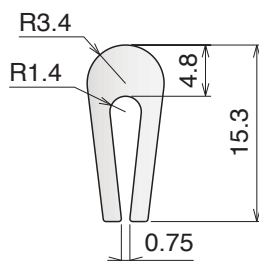
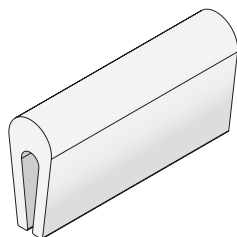

Part	Article-Nr.	L	Colour	Availability
1001	100103-30	30 m	white	On request



1002 Copri profilo 3 mm Bar cap 3 mm / Abdeckprofil 3 mm

Fit on 3 mm

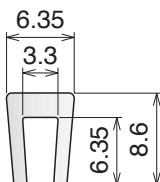
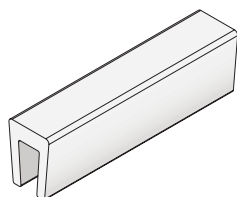

Part	Article-Nr.	L	Colour	Availability
1002	100203-30	30 m	white	On request



1003 Copri profilo 3 mm Bar cap 3 mm / Abdeckprofil 3 mm

Fit on 3 mm

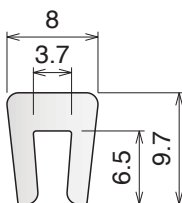
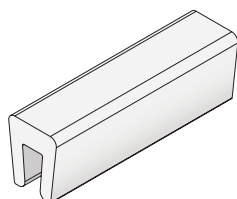

Part	Article-Nr.	L	Colour	Availability
1003	100303-30	30 m	white	On request



1004 Copri profilo 3 mm Bar cap 3 mm / Abdeckprofil 3 mm

Fit on 3 mm

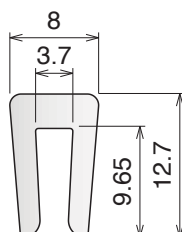
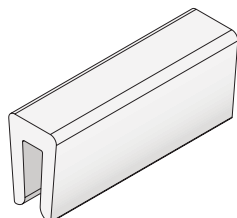

Part	Article-Nr.	L	Colour	Availability
1004	100403-30	30 m	white	On request



1006-153

Guide estruse / Extruded profiles / Extrudiertes Profil

Material:

Polyethylene UHMW-PE with molecular density 5,600,000 g/mol
 Linear expansion coefficient: $1.1 \times 10^{-4} \text{ } ^\circ\text{F}^{-1}$ ($2 \times 10^{-4} \text{ } ^\circ\text{C}^{-1}$)
 Operating temperature: -40 to 176°F (-40 to +80°C)

1006 Copri profilo 5 mm Bar cap 5 mm / Abdeckprofil 5 mm

Fit on 5 mm

Part	Article-Nr.	L	Colour	Availability
1006	100603-30	30 m	white	On request

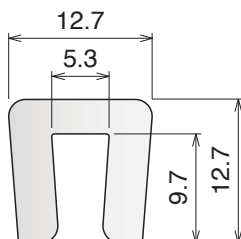
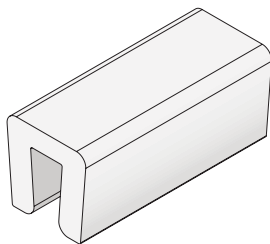

153 Copri profilo 5 mm Bar cap 5 mm / Abdeckprofil 5 mm

Fit on 4/5 mm

Part	Article-Nr.	L	Colour	Availability
153	15302	6 m	green	On request
153	15302C	3 m	green	On request
153	15303	6 m	white	On request
153	15303-30	30 m	white	Stock item
153	15300	6 m	BluLab	Stock item
153	15300-30	30 m	BluLab	Stock item
153	15300C	3 m	BluLab	On request

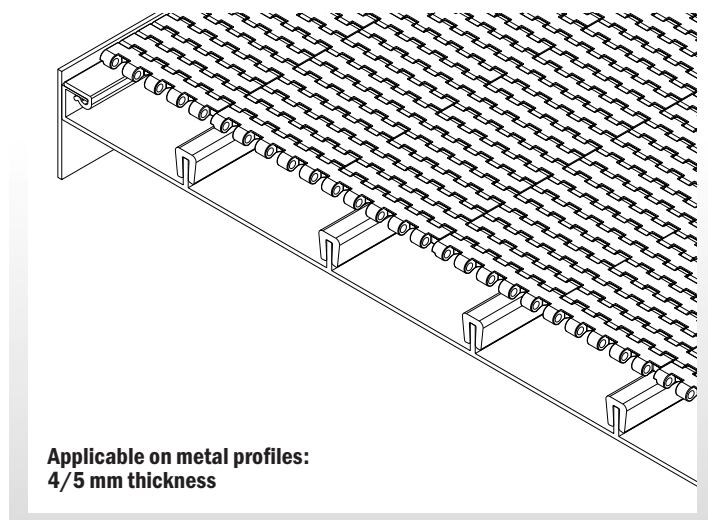
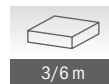
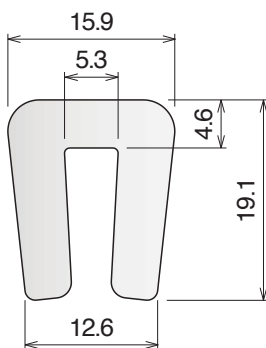
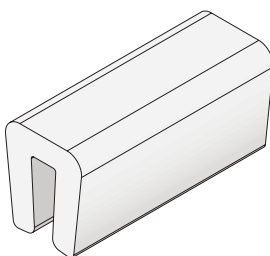

Material:

Polyethylene UHMW-PE with molecular density 5,600,000 g/mol
 Linear expansion coefficient: $1.1 \times 10^{-4} \text{ } ^\circ\text{F}^{-1}$ ($2 \times 10^{-4} \text{ } ^\circ\text{C}^{-1}$)
 Operating temperature: -40 to 176°F (-40 to +80°C)

1007

Copri profilo 5 mm
 Bar cap 5 mm / Abdeckprofil 5 mm

Fit on 5 mm

Part	Article-Nr.	L	Colour	Availability
------	-------------	---	--------	--------------

1007	100703	6 m	white	On request
1007	100703B	6 m	BluLub	On request

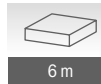
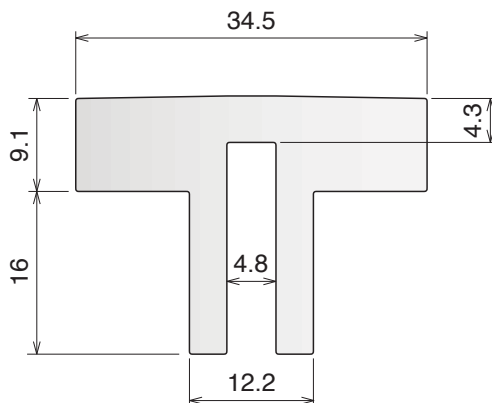
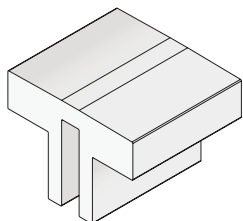

1008

Copri profilo 5 mm
 Bar cap 5 mm / Abdeckprofil 5 mm

Fit on 5 mm

Part	Article-Nr.	L	Colour	Availability
------	-------------	---	--------	--------------

1008	100803	6 m	white	On request
1008	100803B	6 m	BluLub	On request

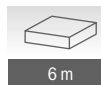
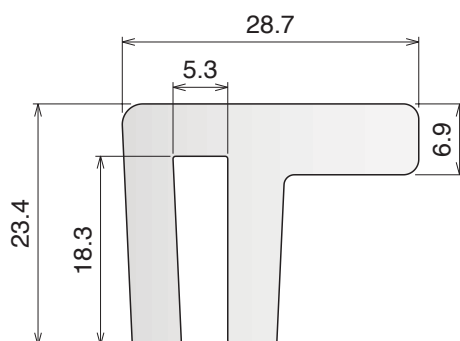
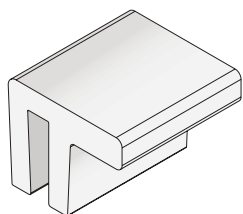

1009

Copri profilo 6 mm
 Bar cap 6 mm / Abdeckprofil 6 mm

Fit on 6 mm

Part	Article-Nr.	L	Colour	Availability
------	-------------	---	--------	--------------

1009	100903-30	30 m	white	On request
------	-----------	------	-------	------------

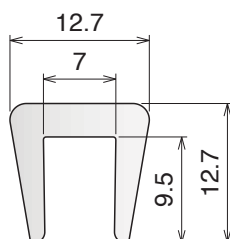
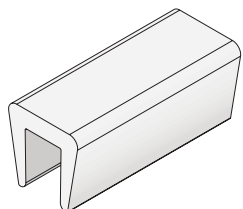

1010-1011-1012-1013

Guide estruse / Extruded profiles / Extrudiertes Profil

Material:

Polyethylene UHMW-PE with molecular density 5,600,000 g/mol
 Linear expansion coefficient: $1.1 \times 10^{-4} \text{ } ^\circ\text{F}^{-1}$ ($2 \times 10^{-4} \text{ } ^\circ\text{C}^{-1}$)
 Operating temperature: -40 to 176°F (-40 to +80°C)

1010 Copri profilo 6 mm Bar cap 6 mm / Abdeckprofil 6 mm

Fit on 6 mm

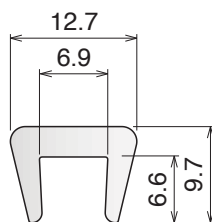
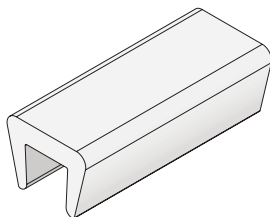

Part	Article-Nr.	L	Colour	Availability
1010	101003-30	30 m	white	On request



1011 Copri profilo 10 mm Bar cap 10 mm / Abdeckprofil 10 mm

Fit on 10 mm

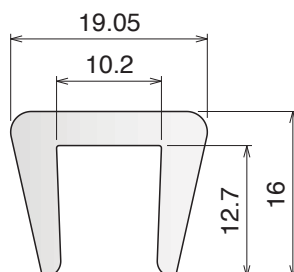
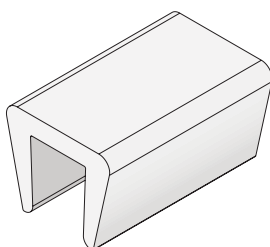

Part	Article-Nr.	L	Colour	Availability
1011	101103-30	30 m	white	On request
1011	101103-60	60 m	white	On request



1012 Copri profilo 12-13 mm Bar cap 12-13 mm / Abdeckprofil 12-13 mm

Fit on 12/13 mm

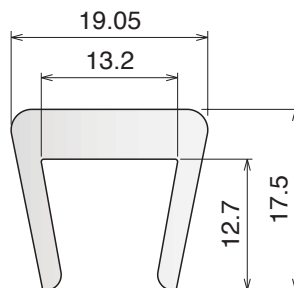
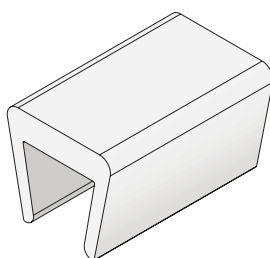

Part	Article-Nr.	L	Colour	Availability
1012	101203-30	30 m	white	On request



1013 Copri profilo 10 mm Bar cap 10 mm / Abdeckprofil 10 mm

Fit on 10 mm

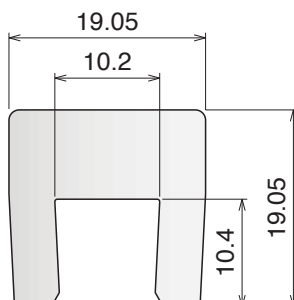
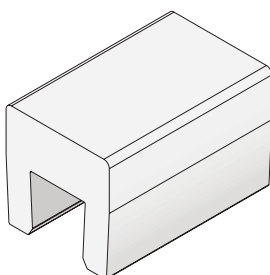

Part	Article-Nr.	L	Colour	Availability
1013	101303	6 m	white	On request



Material:

Polyethylene UHMW-PE with molecular density 5,600,000 g/mol
 Linear expansion coefficient: $1.1 \times 10^{-4} \text{ } ^\circ\text{F}^{-1}$ ($2 \times 10^{-4} \text{ } ^\circ\text{C}^{-1}$)
 Operating temperature: -40 to 176°F (-40 to +80°C)

1040

Guide estruse / Extruded profiles / Extrudiertes Profil

1040
Guide tappeto
Belt side guide / Seitentükuung für matterkette

Fit on 3 mm

Part	Article-Nr.	L	Colour	Availability
1040	104003C	3 m	white	On request
1040	104003	6 m	white	On request

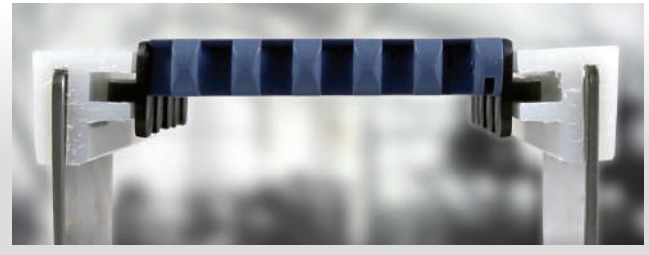
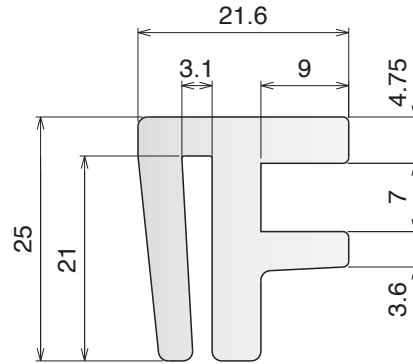
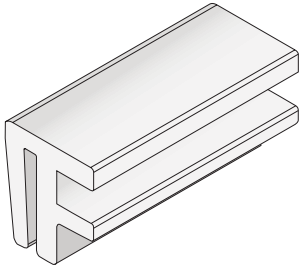

Applicable on metal profiles: 3 mm

119 Guida conica tonda Guide rail round / konische Führung rund

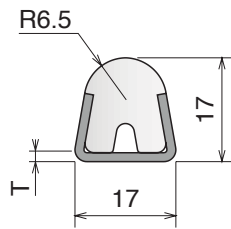
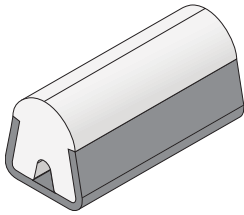

Part	Article-Nr.	L	T	Metal profile	Colour	Availability	Type
119	11963	3 m	1.9	AISI 304	white	On request	
119	11967	6 m	1.9	AISI 304	white	On request	
119	11963B	3 m	1.9	AISI 304	BluLub	On request	
119	11967B	6 m	1.9	AISI 304	BluLub	On request	
119	11901C	3 m	1.5	AISI 304	white	Stock item	
119	11901	6 m	1.5	AISI 304	white	Stock item	
119	11901BC	3 m	1.5	AISI 304	BluLub	Stock item	
119	11901B	6 m	1.5	AISI 304	BluLub	Stock item	

120 Guida conica semitonda Guide rail modified / konische Führung halbrund

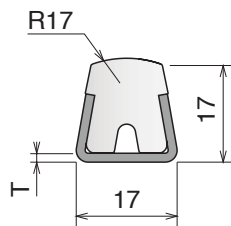
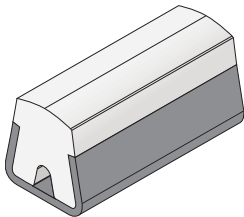

Part	Article-Nr.	L	T	Metal profile	Colour	Availability	Type
120	12063	3 m	1.9	AISI 304	white	On request	
120	12067	6 m	1.9	AISI 304	white	On request	
120	12063B	3 m	1.9	AISI 304	BluLub	On request	
120	12067B	6 m	1.9	AISI 304	BluLub	On request	
120	12001C	3 m	1.5	AISI 304	white	Stock item	
120	12001	6 m	1.5	AISI 304	white	Stock item	
120	12001BC	3 m	1.5	AISI 304	BluLub	Stock item	
120	12001B	6 m	1.5	AISI 304	BluLub	Stock item	

121 Guida conica piatta Guide rail flat / konische Führung flach

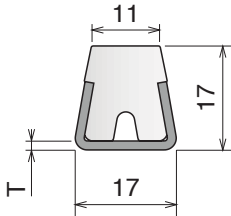
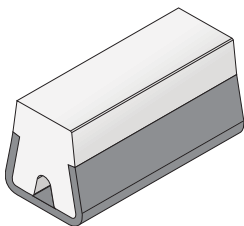

Part	Article-Nr.	L	T	Metal profile	Colour	Availability	Type
121	12163	3 m	1.9	AISI 304	white	On request	
121	12167	6 m	1.9	AISI 304	white	On request	
121	12163B	3 m	1.9	AISI 304	BluLub	On request	
121	12167B	6 m	1.9	AISI 304	BluLub	On request	
121	12101C	3 m	1.5	AISI 304	white	Stock item	
121	12101	6 m	1.5	AISI 304	white	Stock item	
121	12101BC	3 m	1.5	AISI 304	BluLub	Stock item	
121	12101B	6 m	1.5	AISI 304	BluLub	Stock item	

152 Guida conica 25° Guide rail 25° / konische Führung 25°

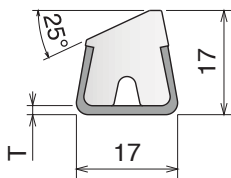
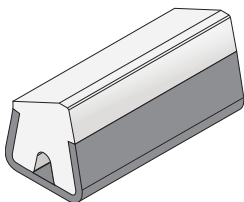

Part	Article-Nr.	L	T	Metal profile	Colour	Availability	Type
152	15263	3 m	1.9	AISI 304	white	On request	
152	15201C	3 m	1.5	AISI 304	white	Stock item	



3/6 m

1067 Guida conica H 18 Guide rail H 18 / konische Führung H 18

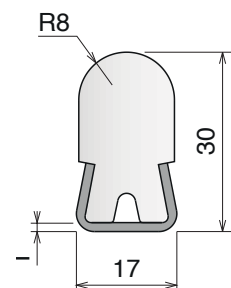
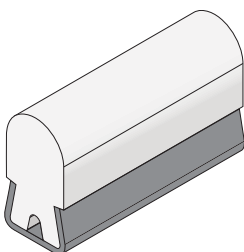

Part	Article-Nr.	L	T	Metal profile	Colour	Availability	Type
1067	106763	3 m	1.9	AISI 304	white	On request	
1067	106701C	3 m	1.5	AISI 304	white	On request	



3/6 m

Material:
Metal profile: Stainless steel
Plastic profile: UHMW-PE

122 Guida conica profilo a T 25,4 mm Guide rail T-shape 25,4 mm / konische Führung flach (T) 25,4 mm

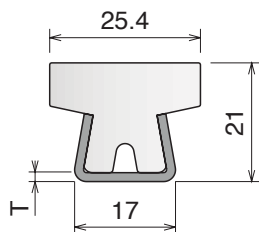
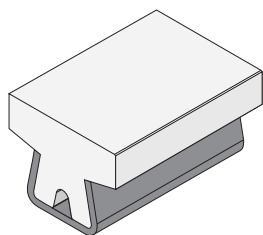

Part	Article-Nr.	L	T	Metal profile	Colour	Availability	Type
122	12263	3 m	1.9	AISI 304	white	On request	
122	12201C	3 m	1.5	AISI 304	white	Stock item	

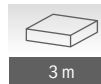

3 m

123 Guida conica profilo a T 31,75 mm Guide rail T-shape 31,75 mm / konische Führung flach (T) 31,75 mm

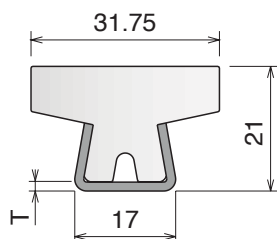
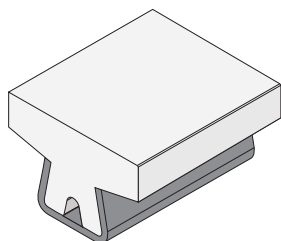

Part	Article-Nr.	L	T	Metal profile	Colour	Availability	Type
123	12363	3 m	1.9	AISI 304	white	On request	
123	12301C	3 m	1.5	AISI 304	white	Stock item	

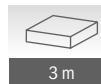

3 m

140 Guida conica profilo a T 25,4 mm Guide rail T-shape 25,4 mm / konische Führung flach (T) 25,4 mm

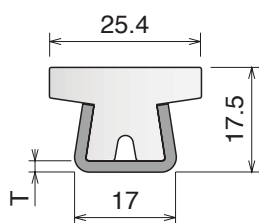
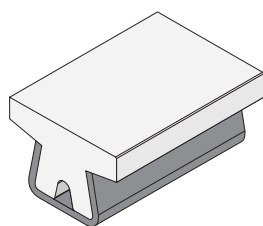

Part	Article-Nr.	L	T	Metal profile	Colour	Availability	Type
140	14063	3 m	1.9	AISI 304	white	On request	
140	14001C	3 m	1.5	AISI 304	white	Stock item	

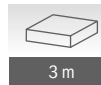

3 m

146 Guida conica profilo a T 31,75 mm Guide rail T-shape 31,75 mm / konische Führung flach (T) 31,75 mm

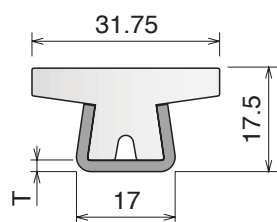
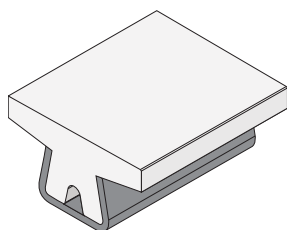

Part	Article-Nr.	L	T	Metal profile	Colour	Availability	Type
146	14663	3 m	1.9	AISI 304	white	On request	
146	14601C	3 m	1.5	AISI 304	white	Stock item	

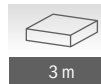

3 m

124 Guida conica profilo a T 40 mm Guide rail T-shape 40 mm / konische Führung flach (T) 40 mm

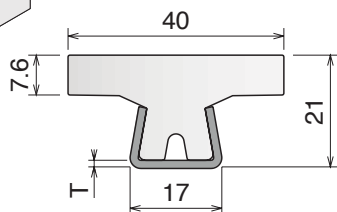
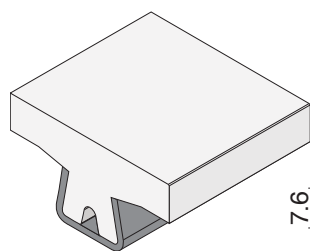

Part	Article-Nr.	L	T	Metal profile	Colour	Availability	Type
124	12463	3 m	1.9	AISI 304	white	On request	
124	12401C	3 m	1.5	AISI 304	white	Stock item	

3 m

143 Guida conica profilo a "T" 19,05 mm Guide rail T-shape 19,05 mm / konische Führung flach (T) 19,05 mm

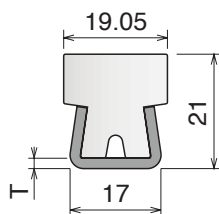
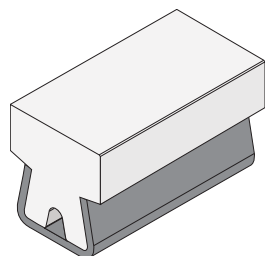

Part	Article-Nr.	L	T	Metal profile	Colour	Availability	Type
143	14363	3 m	1.9	AISI 304	white	On request	
143	14301C	3 m	1.5	AISI 304	white	Stock item	

3 m

141 Guida conica profilo a "T" 57,15 mm Guide rail T-shape 57,15 mm / konische Führung flach (T) 57,15 mm

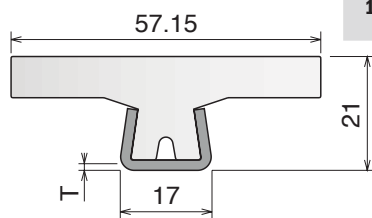
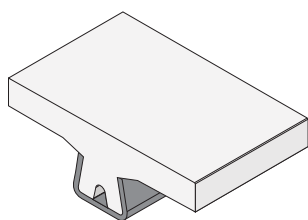

Part	Article-Nr.	L	T	Metal profile	Colour	Availability	Type
141	14163	3 m	1.9	AISI 304	white	On request	
141	14101C	3 m	1.5	AISI 304	white	Stock item	

3 m

142 Guida conica profilo a "T" 43,2 mm Guide rail T-shape 43,2 mm / konische Führung flach (T) 43,2 mm

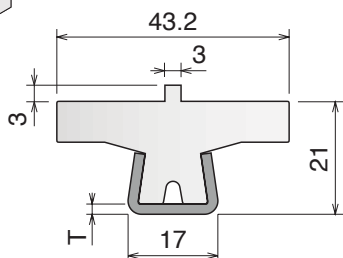
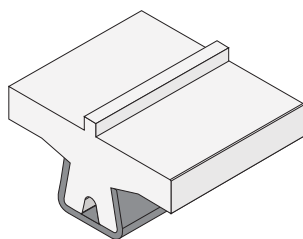

Part	Article-Nr.	L	T	Metal profile	Colour	Availability	Type
142	14263	3 m	1.9	AISI 304	white	On request	
142	14201C	3 m	1.5	AISI 304	white	Stock item	

3 m

Material:
Metal profile: Stainless steel
Plastic profile: UHMW-PE

125 Guida conica profilo a "L" 31,75 mm Guide rail L-shape 31,75 mm / konische Führung flach (L) 31,75 mm

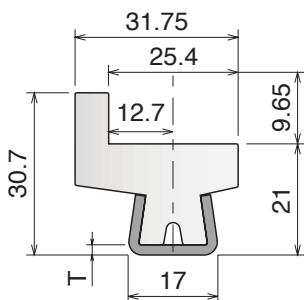
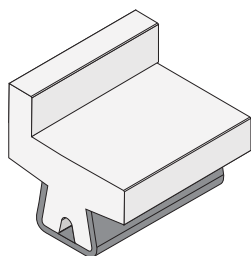

Part	Article-Nr.	L	T	Metal profile	Colour	Availability	Type
125	12563	3 m	1.9	AISI 304	white	On request	
125	12501C	3 m	1.5	AISI 304	white	Stock item	

144 Guida conica profilo a "L" 31,75 mm Guide rail L-shape 31,75 mm / konische Führung flach (L) 31,75 mm

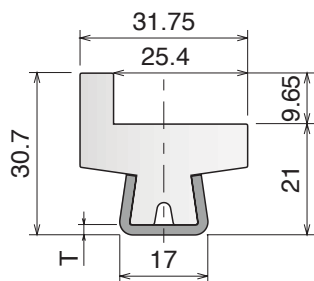
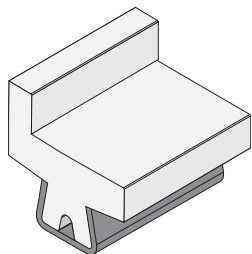

Part	Article-Nr.	L	T	Metal profile	Colour	Availability	Type
144	14463	3 m	1.9	AISI 304	white	On request	
144	14401C	3 m	1.5	AISI 304	white	Stock item	

184 Guida conica per catena Guide rail for chain / konische Führung

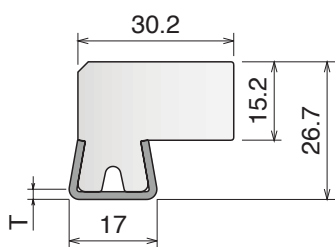
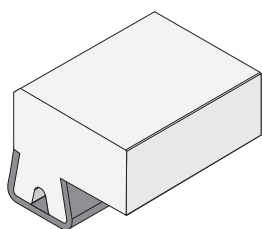

Part	Article-Nr.	L	T	Metal profile	Colour	Availability	Type
184	18463	3 m	1.9	AISI 304	white	On request	
184	18401C	3 m	1.5	AISI 304	white	Stock item	

145 Guida tappeto Belt side guide / Seitenführung für Mattenkette

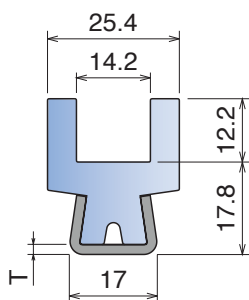
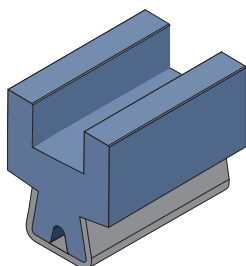

Part	Article-Nr.	L	T	Metal profile	Colour	Availability	Type
145	14563	3 m	1.9	AISI 304	BluLub	On request	
145	14503C	3 m	1.5	AISI 304	BluLub	Stock item	

Bendable profile, generally used with sideflexing belt 600 series

Material:

Polyethylene UHMW-PE with molecular density 5,600,000 g/mol
 Linear expansion coefficient: $1.1 \times 10^{-4} \text{ } ^\circ\text{F}^{-1}$ ($2 \times 10^{-4} \text{ } ^\circ\text{C}^{-1}$)
 Operating temperature: -40 to 176°F (-40 to +80°C)

130 Profilo in alluminio Aluminum rail for bottle guide / Aluminium profil

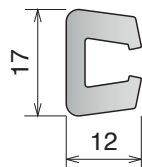
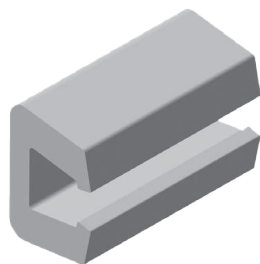

Type A

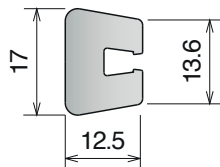

Type B

Part	Article-Nr.	L	Material	Type	Availability
130	13001C	3 m	Aluminium	A	Stock item
130	13001	6 m	Aluminium	A	On request
130	13002C	3 m	Aluminium	B	On request

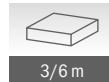

3/6 m

188 Profilo in alluminio Aluminum rail for bottle guide / Aluminium profil

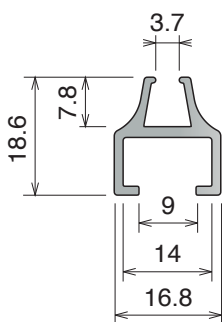
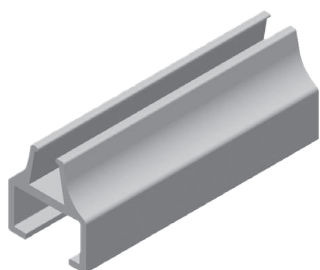

Part	Article-Nr.	L	Material	Availability
188	18801C	3 m	Aluminium	Stock item
188	18801	6 m	Aluminium	On request

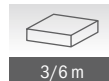

3/6 m

131 Profilo guida bottiglia Plastic rail for bottle guide / Flaschenführungsprofil

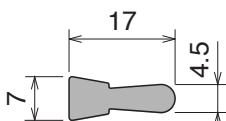
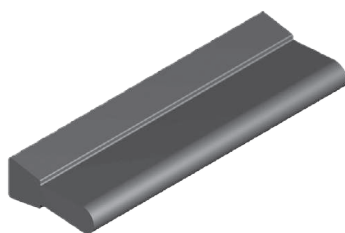

Type A

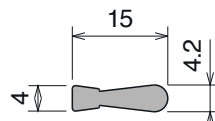

Type B

Part	Article-Nr.	Color	Type	Availability
131	13101B	BluLub	A	Stock item
131	13101	grey	A	Stock item
131	13102B	BluLub	B	On request
131	13102	grey	B	On request

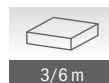

3/6 m

199 Macchina curvatrice Bending machine / Biegemaschine

Part	Article-Nr.
199	19999

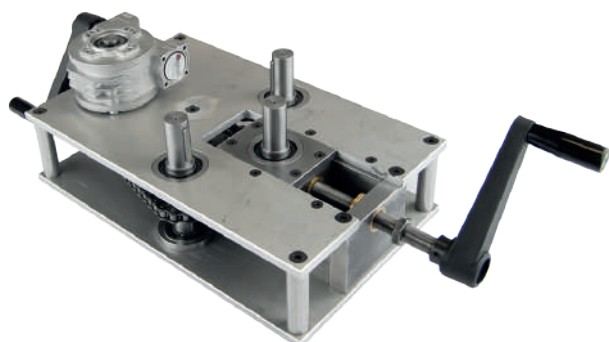

151 Rulli per macchina curvatrice
 Roller for bending machine / Rollen für Biegemaschine

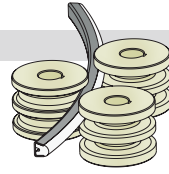

Internal curve



External curve

Part	Article-Nr.	Suitable for Part.
151	15101	119 - 120 - 121

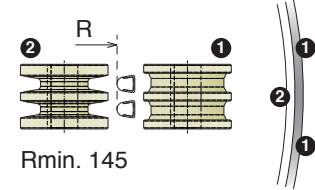
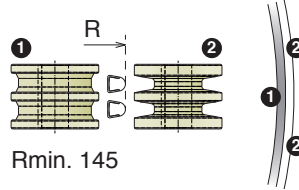

Part	Article-Nr.	Suitable for Part.
151	15102	122 - 123 - 124 - 142 - 140 - 146

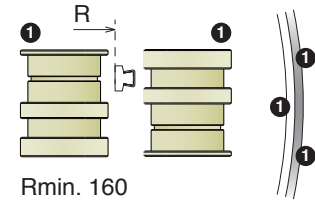
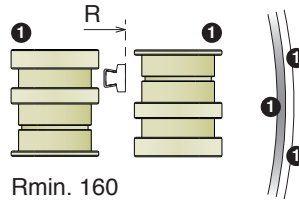
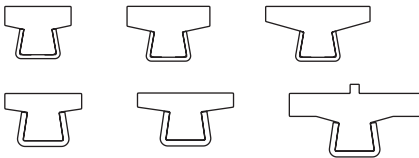

Part	Article-Nr.	Suitable for Part.
151	15103	141

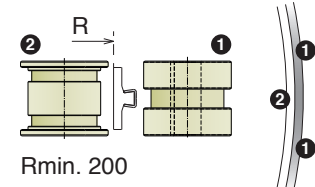
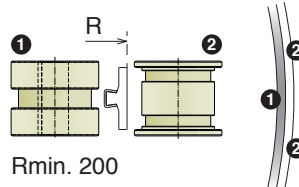
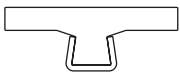

Part	Article-Nr.	Suitable for Part.
151	15104	144

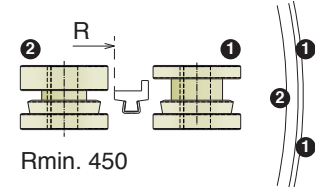
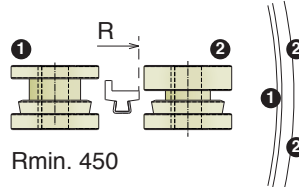
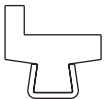

Part	Article-Nr.	Suitable for Part.
151	15105	for Ø8-Ø10-Ø12 - Ø1/2"-Ø5/8"

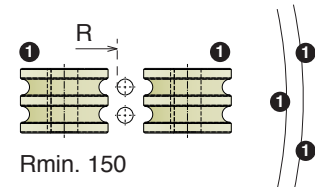
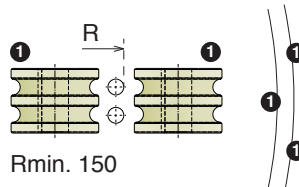
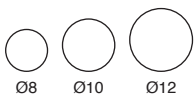

151

Rulli per macchina curvatrice
Roller for bending machine / Rollen für Biegemaschine

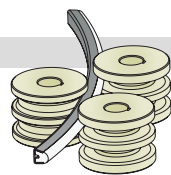

Internal curve

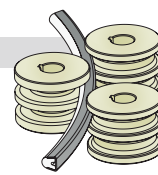

External curve

Part	Article-Nr.	Suitable for Part.
151	15109	358

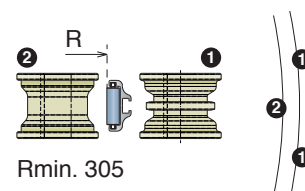
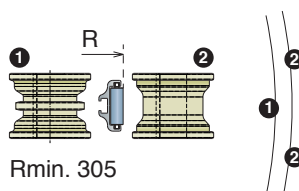

Part	Article-Nr.	Suitable for Part.
151	15110	360

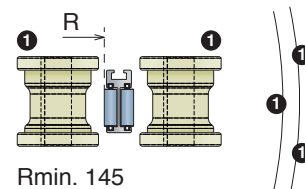
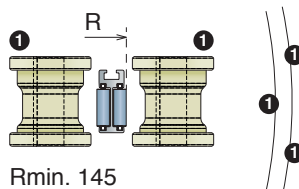

Part	Article-Nr.	Suitable for Part.
151	15106	359

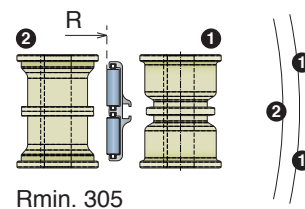
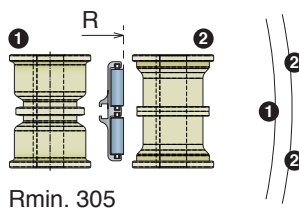
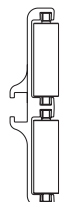

Part	Article-Nr.	Suitable for Part.
151	15107	361

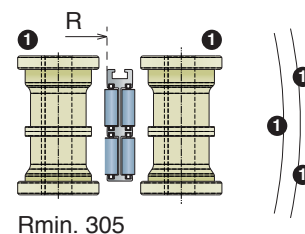
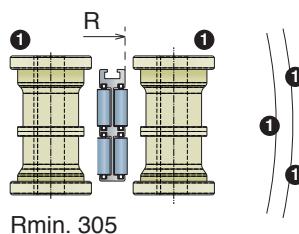
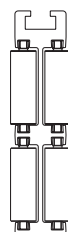

Part	Article-Nr.	Suitable for Part.
151	15108	117

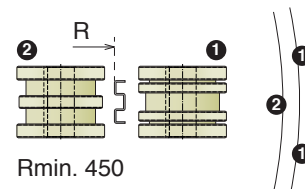
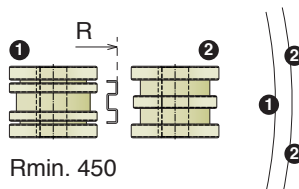

Material: Polyethylene UHMW-PE with molecular density 9,200,000 g/mo.
BluLub, new material with reduced coefficient of friction and higher wear resistance.
 BluLub complies with the code of Federal Regulations of FDA. Linear expansion coefficient:
 $1.1 \times 10^{-4} \text{ } ^\circ\text{F}^{-1}$ ($2 \times 10^{-4} \text{ } ^\circ\text{C}^{-1}$) Operating temperature: -40 to 176°F (-40 to +80°C)

170-168-169-1036-1037

Guide estruse / Extruded profiles / Extrudiertes Profil

170 Guida collo Neck guide / Nackenführung

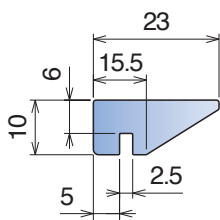
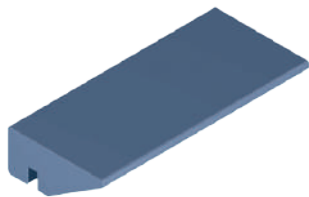

Part	Article-Nr.	L	Material	Availability
170	17001B	3 m	BluLub	Stock item
170	17002B	6 m	BluLub	On request
170	17000B	30 m	BluLub	On request

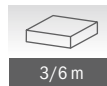

168 Guida collo Neck guide / Nackenführung

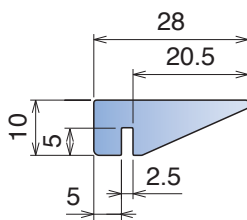
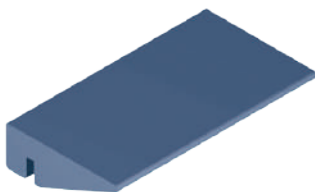

Part	Article-Nr.	L	Material	Availability
168	16801B	3 m	BluLub	Stock item
168	16802B	6 m	BluLub	On request
168	16800B	30 m	BluLub	On request

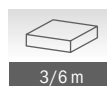

169 Guida collo Neck guide / Nackenführung

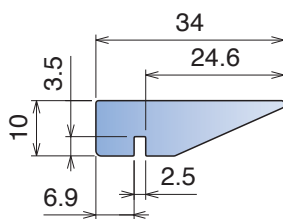
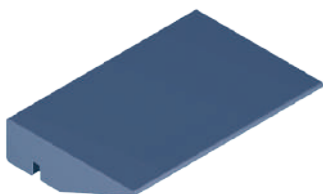

Part	Article-Nr.	L	Material	Availability
169	16901B	3 m	BluLub	Stock item
169	16902B	6 m	BluLub	On request
169	169003	30 m	BluLub	On request

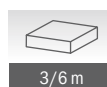
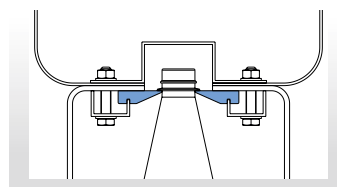

1036 Guida collo Neck guide / Nackenführung

Fit on 1.8-2 mm

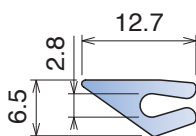
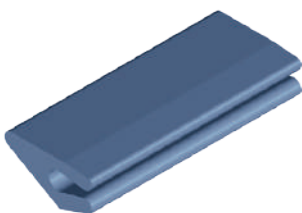

Part	Article-Nr.	L	Material	Availability
1036	103600B	30 m	BluLub	Stock item



1037 Guida collo Neck guide / Nackenführung

Fit on 3 mm

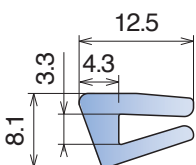
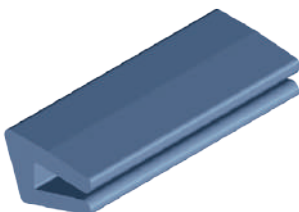

Part	Article-Nr.	L	Material	Availability
1037	103700B	30 m	BluLub	Stock item



167-171-172-173-192

Guide estruse / Extruded profiles / Extrudiertes Profil

Material: Polyethylene UHMW-PE with molecular density 9,200,000 g/mo. **BluLub**, new material with reduced coefficient of friction and higher wear resistance. BluLub complies with the code of Federal Regulations of FDA. Linear expansion coefficient: $1.1 \times 10^{-4} \text{ } ^\circ\text{F}^{-1}$ ($2 \times 10^{-4} \text{ } ^\circ\text{C}^{-1}$) Operating temperature: -40 to 176 °F (-40 to +80 °C)

167 Guida collo Neck guide / Nackenführung

Fit on 1.8-2 mm

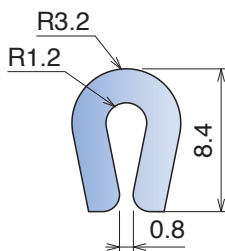

Part	Article-Nr.	L	Material	Availability
167	16700BC	3 m	BluLub	Stock item
167	16700B	6 m	BluLub	Stock item
167	16700B-30	30 m	BluLub	Stock item
167	16700B-75	75 m	BluLub	Stock item

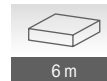
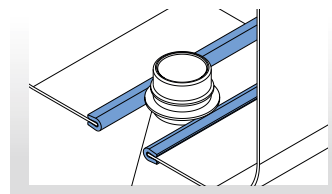

171 Guida collo Neck guide / Nackenführung

Fit on 3 mm

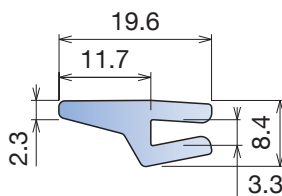
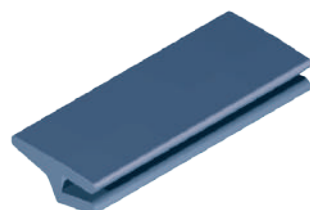

Part	Article-Nr.	L	Material	Availability
171	17100B	30 m	BluLub	Stock item



172 Guida collo Neck guide / Nackenführung

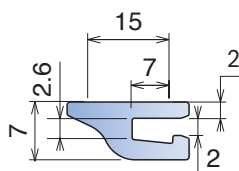
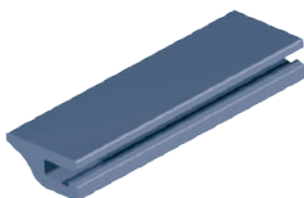

Part	Article-Nr.	L	Material	Availability
172	17200B	30 m	BluLub	Stock item



173 Guida collo Neck guide / Nackenführung

Fit on 1.8-2 mm

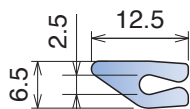
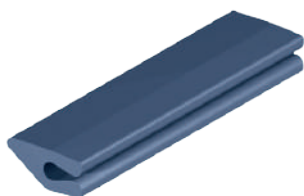

Part	Article-Nr.	L	Material	Availability
173	17300B	30 m	BluLub	Stock item



192 Guida collo Neck guide / Nackenführung

Fit on 1.8-2 mm

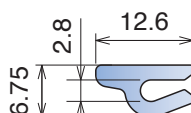
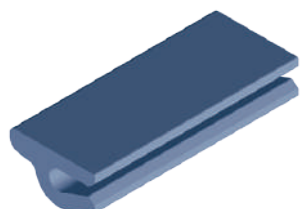

Part	Article-Nr.	L	Material	Availability
192	19200B	30 m	BluLub	Stock item



Material: Polyethylene UHMW-PE with molecular density 9,200,000 g/mo.
BluLub, new material with reduced coefficient of friction and higher wear resistance.
 BluLub complies with the code of Federal Regulations of FDA. Linear expansion coefficient:
 $1.1 \times 10^{-4} \text{ } ^\circ\text{F}^{-1}$ ($2 \times 10^{-4} \text{ } ^\circ\text{C}^{-1}$) Operating temperature: -40 to 176°F (-40 to +80°C)

1062-1068-1072-1073

Guide estruse / Extruded profiles / Extrudiertes Profil

1062 Guida collo Neck guide / Nackenführung

Fit on 1.8-2 mm

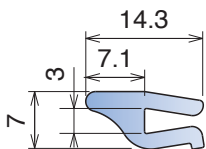
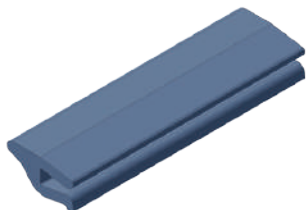

Part	Article-Nr.	L	Material	Availability
1062	106200B	30 m	BluLub	Stock item



1068 Guida collo Neck guide / Nackenführung

Fit on 1.8-2 mm

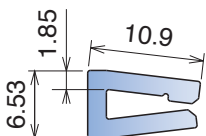
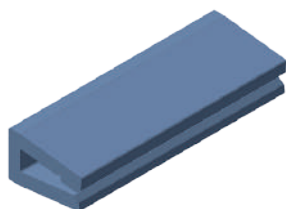

Part	Article-Nr.	L	Material	Availability
1068	106800B	30 m	BluLub	Stock item



1072 Guida collo Neck guide / Nackenführung

Fit on 1.8-2 mm

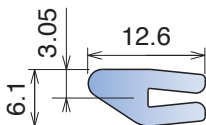
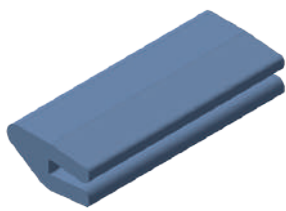

Part	Article-Nr.	L	Material	Availability
1072	107200B	30 m	BluLub	Stock item



1073 Guida collo Neck guide / Nackenführung

Fit on 1.8-2 mm

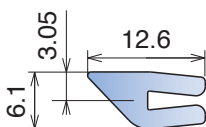
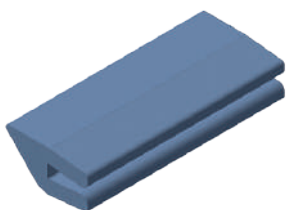

Part	Article-Nr.	L	Material	Availability
1073	107300B	30 m	BluLub	Stock item



Material:

Polyethylene UHMW-PE with molecular density 9,200,000 g/mol
 Linear expansion coefficient: $1.1 \times 10^{-4} \text{ } ^\circ\text{F}^{-1}$ ($2 \times 10^{-4} \text{ } ^\circ\text{C}^{-1}$)
 Operating temperature: -40 to 176°F (-40 to +80°C)

163 Profilo 25 mm per guida in alluminio Profile 25 mm for aluminum guide / C-Profil f. Aluminiumprofil

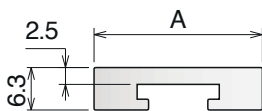
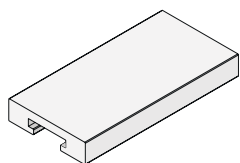

Part	Article-Nr.	A	L	Colour	Availability
163	16303C	25,4	3 m	white	Stock item
163	16303	25,4	6 m	white	On request
163	16313C	31,75	3 m	white	Stock item
163	16313	31,75	6 m	white	On request
163	16323C	35,0	3 m	white	Stock item
163	16323	35,0	6 m	white	On request
163	16324C	38,1	3 m	white	Stock item
163	16324	38,1	6 m	white	On request

160 Profilo 20 mm per guida in alluminio Profile 20 mm for aluminum guide / C-Profil f. Aluminiumprofil

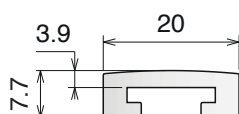
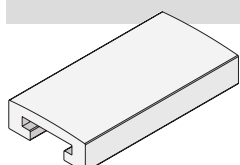

Part	Article-Nr.	L	Colour	Availability
160	16003C	3 m	white	Stock item
160	16003	6 m	white	On request

161 Profilo 20 mm per guida in alluminio Profile 20 mm for aluminum guide / C-Profil f. Aluminiumprofil

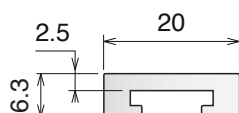
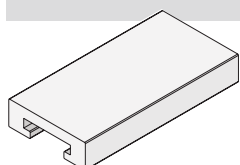

Part	Article-Nr.	L	Colour	Availability
161	16103C	3 m	white	Stock item
161	16103	6 m	white	On request

162 Profilo tondo per guida in alluminio Round profile for aluminum guide / Pilzprofil f. Aluminiumprofil

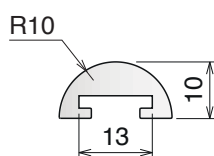
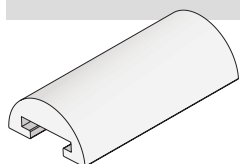

Part	Article-Nr.	L	Colour	Availability
162	16202C	3 m	green	Stock item
162	16202	6 m	green	On request
162	16203C	3 m	white	Stock item
162	16203	6 m	white	On request

164 Guida in alluminio Aluminum guide / Aluminiumprofil

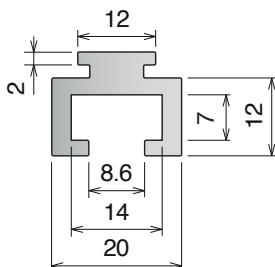
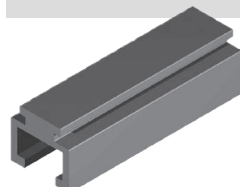

Part	Article-Nr.	L	Material	Availability
164	16401C	3 m	Aluminium	Stock item
164	16401	6 m	Aluminium	On request

Fixing screw:
 M8 hex.head
 or **PART 362**

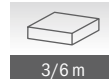

165 Guida in alluminio Aluminum guide / Aluminiumprofil

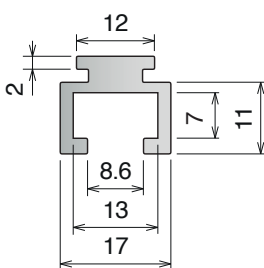
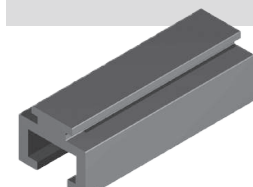

Part	Article-Nr.	L	Material	Availability
165	16501C	3 m	Aluminium	Stock item
165	16501	6 m	Aluminium	On request

Fixing screw:
 M8 hex.head
 or **PART 362**

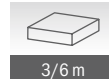

Material: Polyethylene UHMW-PE with molecular density 9,200,000 g/mo.
BluLub, new material with reduced coefficient of friction and higher wear resistance.
 BluLub complies with the code of Federal Regulations of FDA. Linear expansion coefficient:
 $1.1 \times 10^{-4} \text{ } ^\circ\text{F}^{-1}$ ($2 \times 10^{-4} \text{ } ^\circ\text{C}^{-1}$) Operating temperature: -40 to 176°F (-40 to +80°C)

154 Guida laterale Side guide rail / Seitenführungen

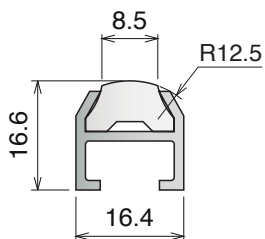
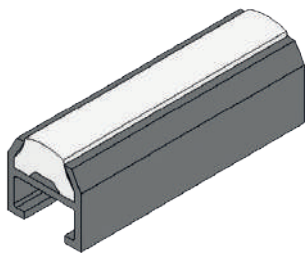

Part	Article-Nr.	L	Colour	Availability
154	15401C	3 m	white	Stock item
154	15401	6 m	white	On request
154	15401BC	3 m	BluLub	Stock item
154	15401B	6 m	BluLub	On request

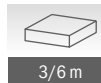

3/6 m

155 Guida laterale Side guide rail / Seitenführungen

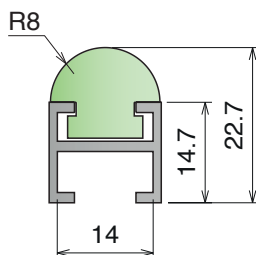
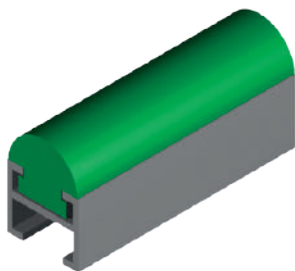

Part	Article-Nr.	L	Colour	Availability
155	15501C	3 m	green	Stock item
155	15501	6 m	green	On request

Fixing screw:
M8 hex. head
or PART 362

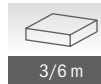

3/6 m

134 Guida standard Standard guide rail / Seitenführung

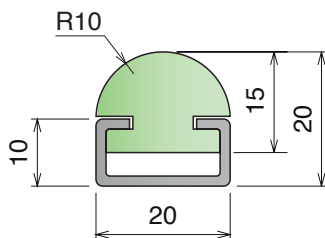
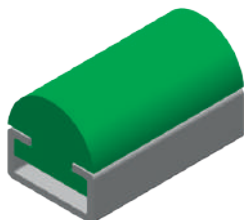

Part	Article-Nr.	L	Colour	Availability
134	13401C	3 m	green	Stock item
134	13401	6 m	green	On request

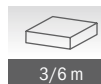

3/6 m

Material:

Polyethylene UHMW-PE with molecular density 9,200,000 g/mol
 Linear expansion coefficient: $1.1 \times 10^{-4} \text{ } ^\circ\text{F}^{-1}$ ($2 \times 10^{-4} \text{ } ^\circ\text{C}^{-1}$)
 Operating temperature: -40 to 176°F (-40 to +80°C)

1041 Profilo "C" C-Profile / C-Profil

Fit on 5x25 mm

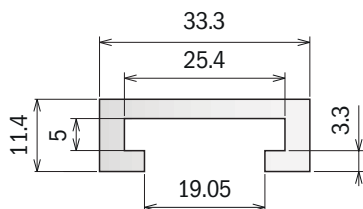
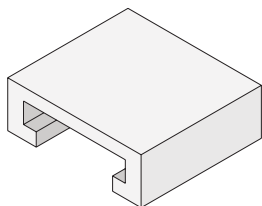

Part	Article-Nr.	L	Colour	Availability
1041	104103C	3 m	white	On request
1041	104103	6 m	white	On request

**NORTH
AMERICA
STANDARD**

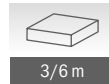

1042 Profilo "C" C-Profile / C-Profil

Fit on 6x50 mm

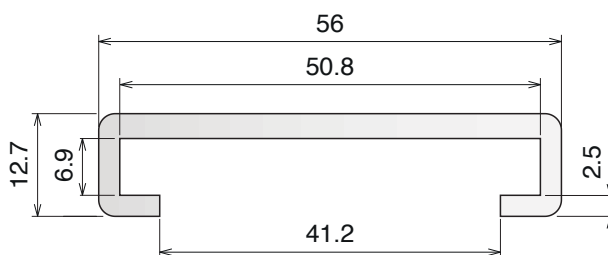
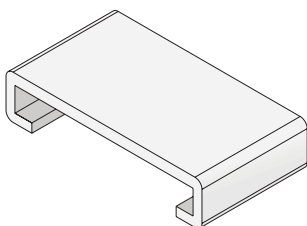

Part	Article-Nr.	L	Colour	Availability
1042	104203C	3 m	white	On request
1042	104203	6 m	white	On request

**NORTH
AMERICA
STANDARD**

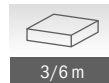

1043 Profilo "C" C-Profile / C-Profil

Fit on 6x50 mm

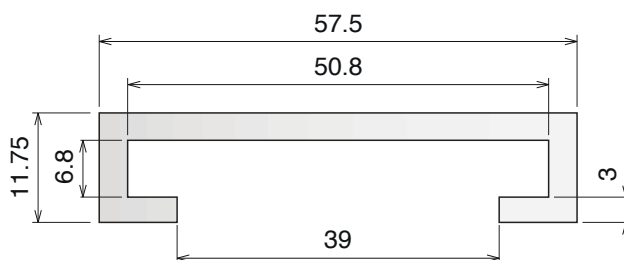
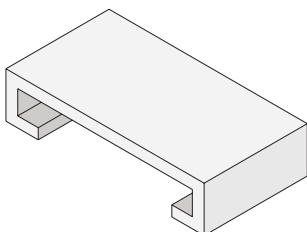

Part	Article-Nr.	L	Colour	Availability
1043	104303C	3 m	white	On request
1043	104303	6 m	white	On request

**NORTH
AMERICA
STANDARD**

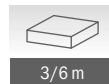

Material:

Polyethylene UHMW-PE with molecular density 9,200,000 g/mol
 Linear expansion coefficient: $1.1 \times 10^{-4} \text{ } ^\circ\text{F}^{-1}$ ($2 \times 10^{-4} \text{ } ^\circ\text{C}^{-1}$)
 Operating temperature: -40 to 176°F (-40 to +80°C)

1044-1045-1053-1054

Guide estruse / Extruded profiles / Extrudiertes Profil

1044 Profilo "C" C-Profile / C-Profil

Fit on 12.7x38.1 mm

Part	Article-Nr.	L	Colour	Availability
1044	104403C	3 m	white	On request
1044	104403	6 m	white	On request

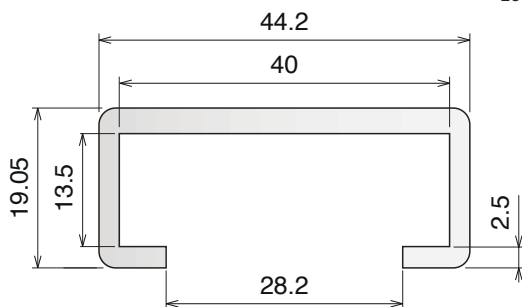
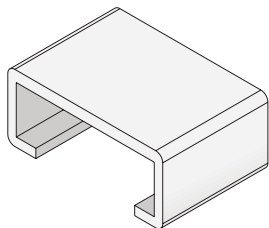

NORTH AMERICA STANDARD

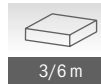

1045 Profilo "C" C-Profile / C-Profil

Fit on 12.7x50.8 mm

Part	Article-Nr.	L	Colour	Availability
1045	104503C	3 m	white	On request
1045	104503	6 m	white	On request

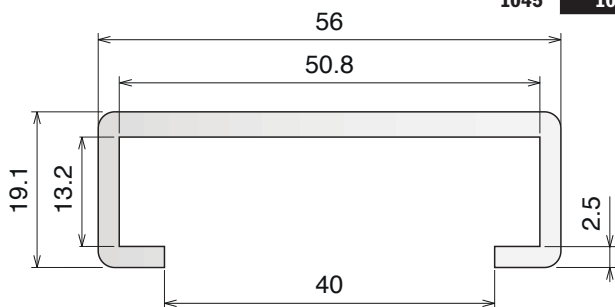
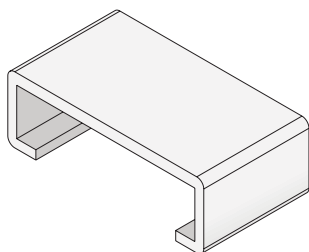

NORTH AMERICA STANDARD

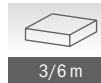

1053 Copri profilo Bar cover / Abdeckprofil

Fit on 6.35x38.1 mm

Part	Article-Nr.	L	Colour	Availability
1053	105303C	3 m	white	On request
1053	105303	6 m	white	On request

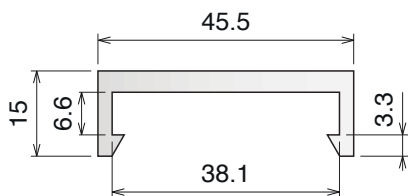
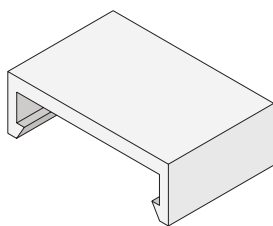

NORTH AMERICA STANDARD

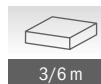

1054 Copri profilo Bar cover / Abdeckprofil

Fit on 6.35x38.1 mm

Part	Article-Nr.	L	Colour	Availability
1054	105403C	3 m	white	On request
1054	105403	6 m	white	On request

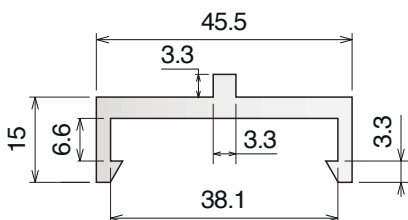
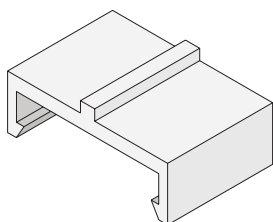

NORTH AMERICA STANDARD

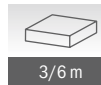

135-136

Guide estruse / Extruded profiles / Extrudiertes Profil

Material:

Polyethylene UHMW-PE with molecular density 9,200,000 g/mol
 Linear expansion coefficient: $1.1 \times 10^{-4} \text{ } ^\circ\text{F}^{-1}$ ($2 \times 10^{-4} \text{ } ^\circ\text{C}^{-1}$)
 Operating temperature: -40 to 176°F (-40 to +80°C)

135

Guida laterale H.78 mm
 Side guide H.78 mm / Seitenführung H.78 mm



Part	Article-Nr.	L	Colour	Availability
135	13501C	3 m	black	Stock item
135	13501	6 m	black	On request
135	13502C	3 m	blu	Stock item
135	13502	6 m	blu	On request



Used with:
PART 394
PART 331

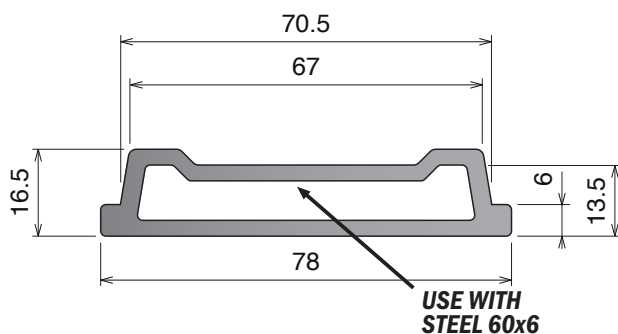
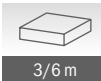

136

Guida laterale H.87 mm
 Side guide H.87 mm / Seitenführung H.87 mm

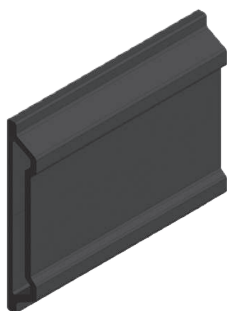

Part	Article-Nr.	L	Colour	Availability
136	13601C	3 m	black	Stock item
136	13601	6 m	black	On request
136	13602C	3 m	blu	Stock item
136	13602	6 m	blu	On request



Used with:
PART 394
PART 345

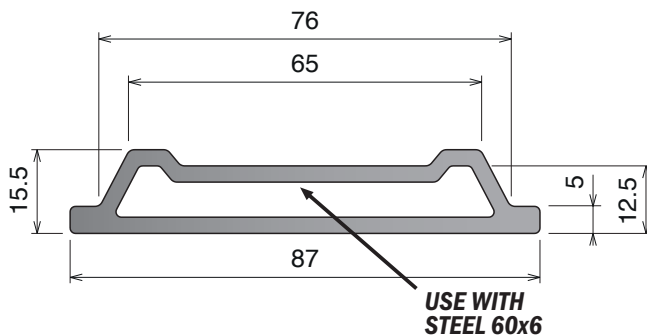

Material:

Polyethylene UHMW-PE with molecular density 5,600,000 g/mol
 Linear expansion coefficient: $1.1 \times 10^{-4} \text{ } ^\circ\text{F}^{-1}$ ($2 \times 10^{-4} \text{ } ^\circ\text{C}^{-1}$)
 Operating temperature: -40 to 176°F (-40 to +80°C)

137 Profilo "C"
 C-Profile / C-Profil

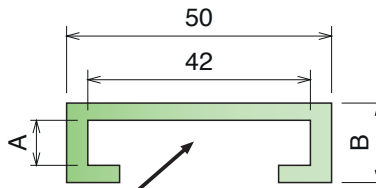
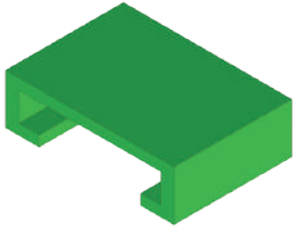

USE WITH STEEL
 40x8 or 40x10

Part	Article-Nr.	L	A	B	Colour	Availability
137	13701C	3 m	8,5	14	green	Stock item
137	13701	6 m	8,5	14	green	On request
137	13701BC	3 m	8,5	14	BluLub	Stock item
137	13701B	6 m	8,5	14	BluLub	On request
137	13702C	3 m	8,5	14	black	Stock item
137	13702	6 m	8,5	14	black	On request
137	13711C	3 m	10,5	16	green	Stock item
137	13711	6 m	10,5	16	green	On request
137	13711BC	3 m	10,5	16	BluLub	Stock item
137	13711B	6 m	10,5	16	BluLub	On request

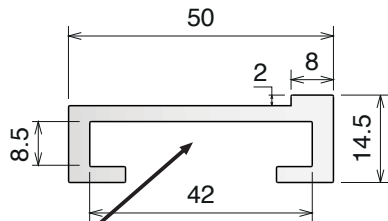
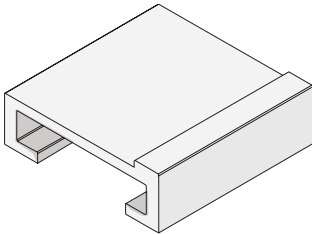

USE WITH STEEL
 40x8

Part	Article-Nr.	L	Colour	Availability
137	13720	6 m	white	On request



Material:

Acciaio inox / Stainless Steel / Edelstahl or
Alluminio / Aluminum / Aluminium

117 Profilo Omega M-Profile / M-Profil

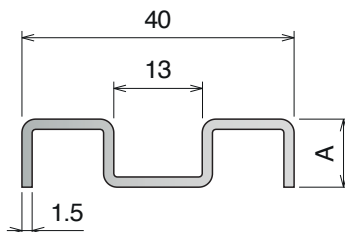
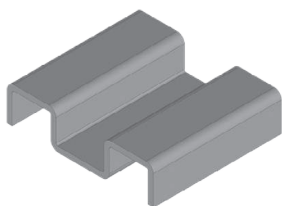

Part	Article-Nr.	L	A	Material	Availability
117	11701C	3 m	8	AISI 304	Stock item
117	11701	6 m	8	AISI 304	On request
117	11702C	3 m	10	AISI 304	Stock item
117	11702	6 m	10	AISI 304	On request
117	11703C	3 m	6	AISI 304	Stock item
117	11703	6 m	6	AISI 304	On request

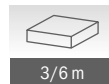

1055 Guida in acciaio inox Stainless steel guide / Edelstahlprofil

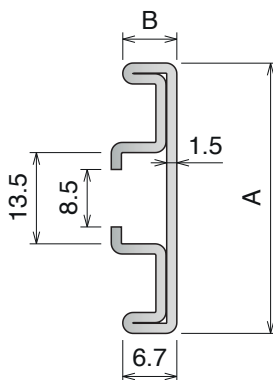
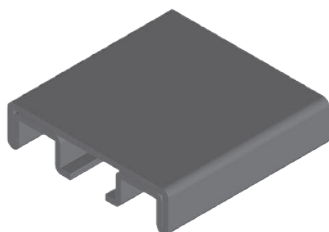

Part	Article-Nr.	L	A	B	Material	Availability
1055	105501C	3 m	40	8	AISI 304	Stock item
1055	105501	6 m	40	8	AISI 304	On request

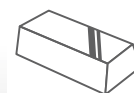

**Stainless steel
AISI 304**

40x8

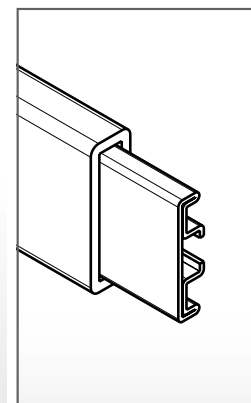

Used with part:

**13701C / 13701BC
18914C / 18914
18301C / 18301**

159 Guida in alluminio Aluminum guide / Aluminiumprofil

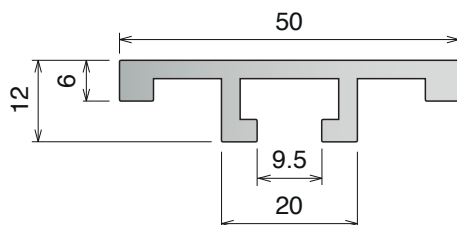
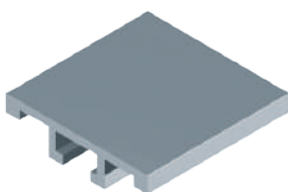

Part	Article-Nr.	L	Material	Availability
159	15901C	3 m	Aluminium	Stock item
159	15901	6 m	Aluminium	On request

Fixing screw:
M8 hex.head
or **PART 362**

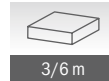

Material:

Polyethylene UHMW-PE with molecular density 5,600,000 g/mol
 Linear expansion coefficient: $1.1 \times 10^{-4} \text{ } ^\circ\text{F}^{-1}$ ($2 \times 10^{-4} \text{ } ^\circ\text{C}^{-1}$)
 Operating temperature: -40 to 176°F (-40 to +80°C)

1063

Guida laterale
 Side guide rail / Seitenführung

Part	Article-Nr.	L	For plate	Colour	Availability
1063	106301C	3 m	30x4	black	Stock item

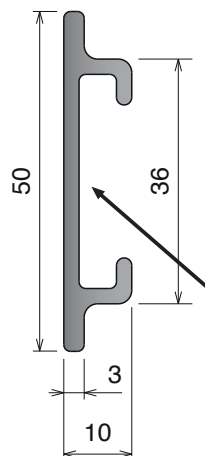
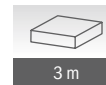
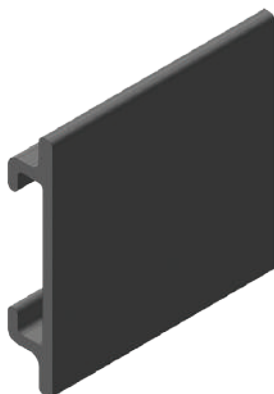

USE WITH
 STEEL 30x4

1064

Guida laterale
 Side guide rail / Seitenführung

Part	Article-Nr.	L	For plate	Colour	Availability
1064	106401C	3 m	55x4	black	Stock item

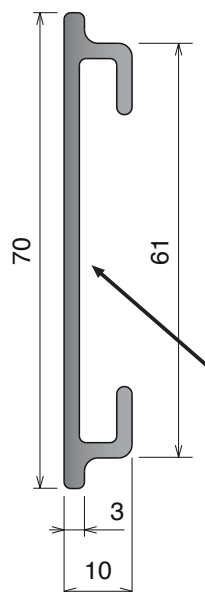
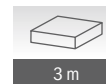
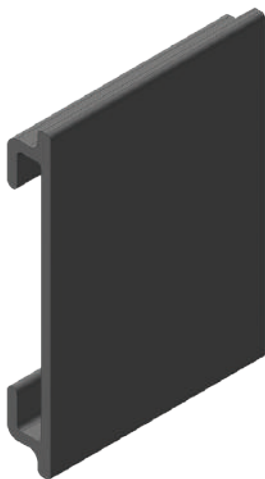

USE WITH
 STEEL 55x4

Material: Polyethylene HMW-PE
BluLub, new material with reduced coefficient of friction and higher wear resistance.
 BluLub complies with the code of Federal Regulations of FDA. Linear expansion coefficient:
 $1.1 \times 10^{-4} \text{ } ^\circ\text{F}^{-1}$ ($2 \times 10^{-4} \text{ } ^\circ\text{C}^{-1}$) Operating temperature: -40 to $176 \text{ } ^\circ\text{F}$ (-40 to $+80 \text{ } ^\circ\text{C}$)

158 Guida laterale Side guide rail / Seitenführung

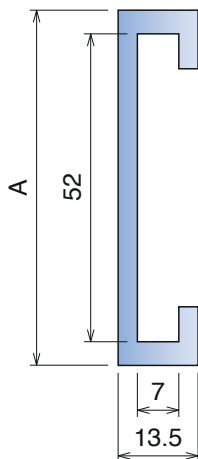

Part	Article-Nr.	L	A	Material	Availability
158	15800C	3 m	60	grey	Stock item
158	15800	6 m	60	grey	On request
158	15800BC	3 m	60	BluLub	Stock item
158	15800B	6 m	60	BluLub	On request

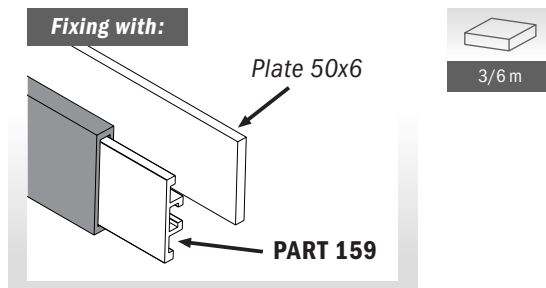

Guida laterale Side guide rail / Seitenführung

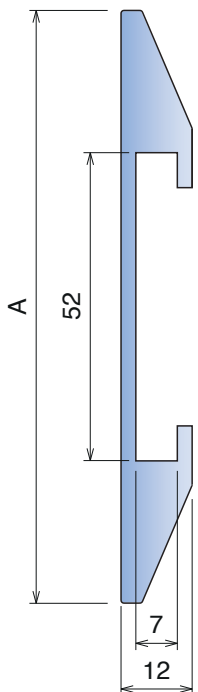

Part	Article-Nr.	L	A	Material	Availability
158	15801C	3 m	90	grey	On request
158	15801	6 m	90	grey	On request
158	15801BC	3 m	90	BluLub	Stock item
158	15801B	6 m	90	BluLub	On request
158	15802C	3 m	100	grey	On request
158	15802	6 m	100	grey	On request
158	15802BC	3 m	100	BluLub	Stock item
158	15802B	6 m	100	BluLub	On request
158	15803C	3 m	120	grey	On request
158	15803	6 m	120	grey	On request
158	15803BC	3 m	120	BluLub	Stock item
158	15803B	6 m	120	BluLub	On request

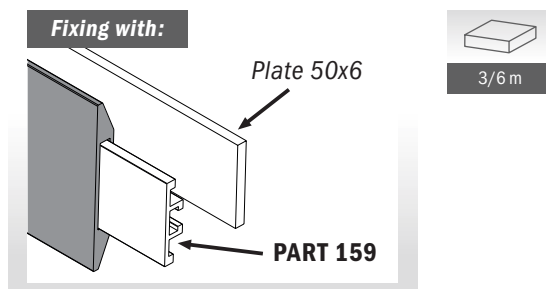

Material: Polyethylene HMW-PE
BluLub, new material with reduced coefficient of friction and higher wear resistance.
 BluLub complies with the code of Federal Regulations of FDA. Linear expansion coefficient:
 $1.1 \times 10^{-4} \text{ } ^\circ\text{F}^{-1}$ ($2 \times 10^{-4} \text{ } ^\circ\text{C}^{-1}$) Operating temperature: -40 to 176°F (-40 to $+80^\circ\text{C}$)

182 Guida laterale Side guide rail / Seitenführung

Part	Article-Nr.	L	For plate	Material	Availability
182	18204C	3 m	50x6	grey	On request
182	18214C	3 m	40x8	grey	On request
182	18200BC	3 m	50x6	BluLub	On request
182	18210BC	3 m	40x8	BluLub	On request

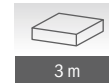
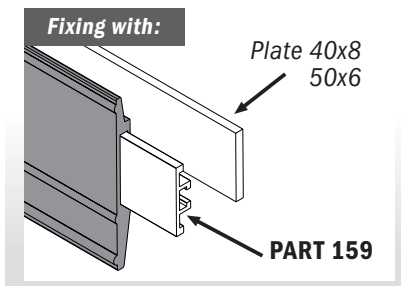
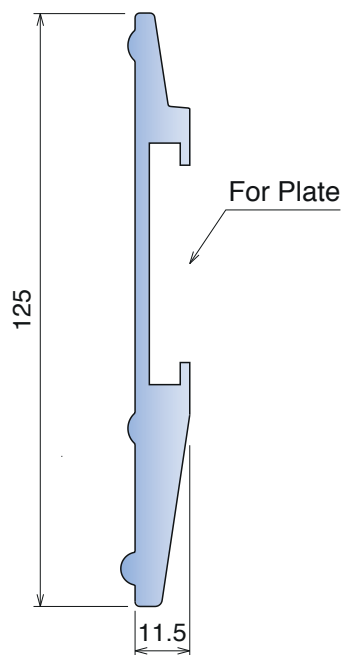
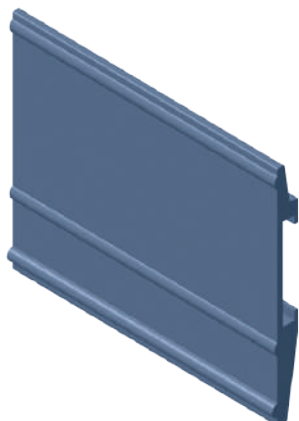

1065 Guida laterale Side guide rail / Seitenführung

Part	Article-Nr.	L	For plate	Material	Availability
1065	106504C	3 m	50x6	grey	On request
1065	106500BC	3 m	50x6	BluLub	On request

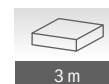
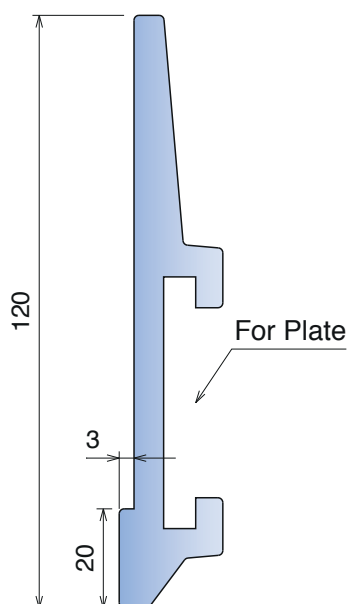
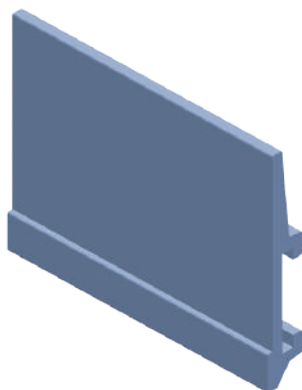

Material: Polyethylene HMW-PE
BluLub, new material with reduced coefficient of friction and higher wear resistance.
 BluLub complies with the code of Federal Regulations of FDA. Linear expansion coefficient:
 $1.1 \times 10^{-4} \text{ } ^\circ\text{F}^{-1}$ ($2 \times 10^{-4} \text{ } ^\circ\text{C}^{-1}$) Operating temperature: -40 to 176 °F (-40 to +80 °C)

189 Guida laterale Side guide rail / Seitenführung

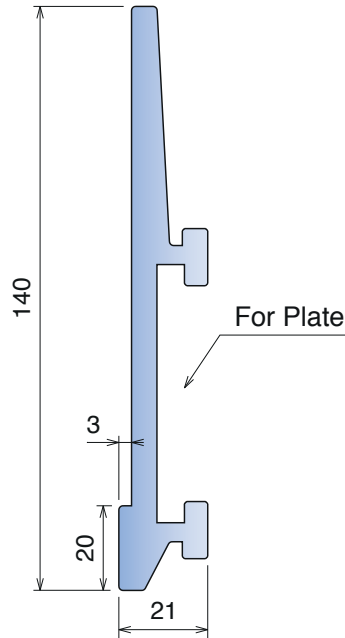
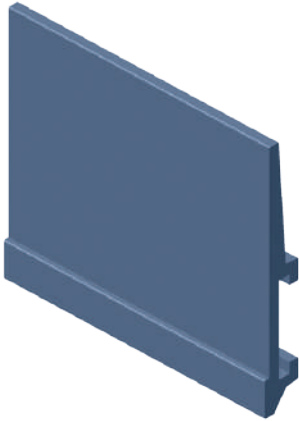

Part	Article-Nr.	L	For plate	Material	Availability
189	18904C	3 m	50x6	grey	On request
189	18900BC	3 m	50x6	BluLub	Stock item
189	18914C	3 m	40x8	grey	On request
189	18910BC	3 m	40x8	BluLub	Stock item

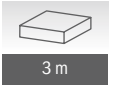
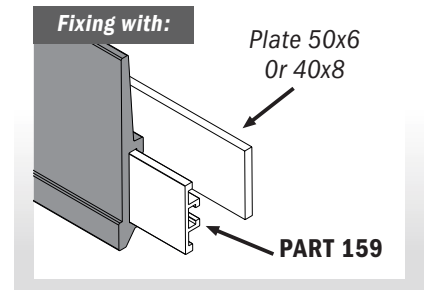

Guida laterale Side guide rail / Seitenführung

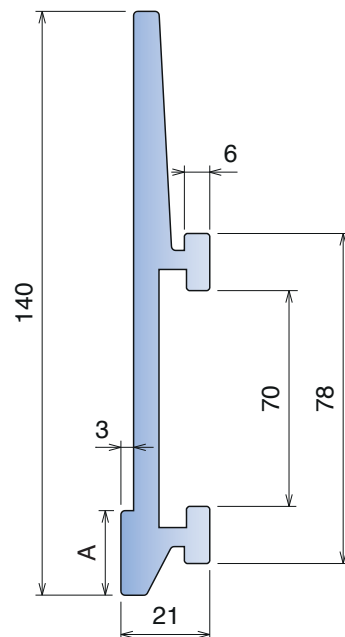
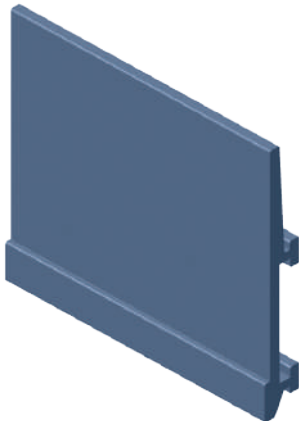

Part	Article-Nr.	L	A	For plate	Material	Availability
189	18924C	3 m	20	60x6	grey	Stock item
189	18920BC	3 m	20	60x6	BluLub	Stock item
189	18934C	3 m	40	60x6	grey	Stock item
189	18930BC	3 m	40	60x6	BluLub	Stock item
189	18944C	3 m	40	60x5	grey	Stock item
189	18940BC	3 m	40	60x5	BluLub	Stock item

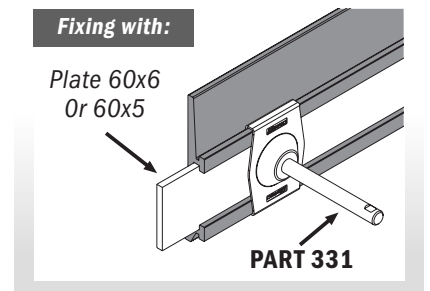

Material: Polyethylene HMW-PE
BluLub, new material with reduced coefficient of friction and higher wear resistance.
 BluLub complies with the code of Federal Regulations of FDA. Linear expansion coefficient:
 $1.1 \times 10^{-4} \text{ } ^\circ\text{F}^{-1}$ ($2 \times 10^{-4} \text{ } ^\circ\text{C}^{-1}$) Operating temperature: -40 to 176°F (-40 to +80°C)

193 Guida laterale Side guide rail / Seitenführung

Part	Article-Nr.	L	For plate	Material	Availability
193	19324C	3 m	60x6	grey	Stock item
193	19320BC	3 m	60x6		Stock item

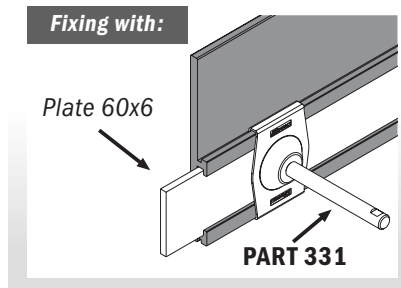
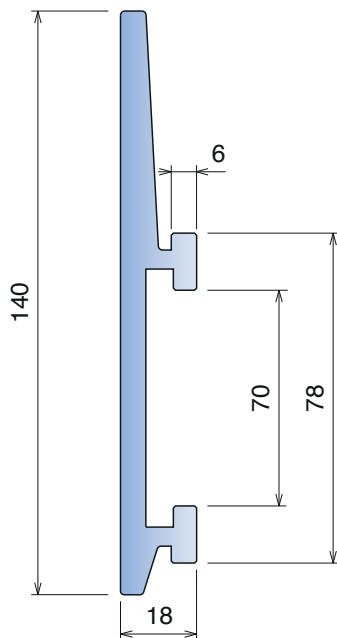
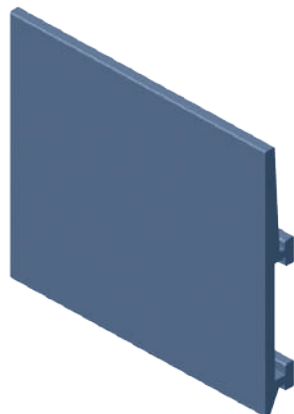

187 Guida laterale Side guide rail / Seitenführung

Part	Article-Nr.	L	A	For plate	Material	Availability
187	18724C	3 m	12	60x6	grey	Stock item
187	18720BC	3 m	12	60x6	BluLub	Stock item
187	18734C	3 m	20	60x6	grey	Stock item
187	18730BC	3 m	20	60x6	BluLub	Stock item
187	18744C	3 m	40	60x6	grey	Stock item
187	18740BC	3 m	40	60x6	BluLub	Stock item

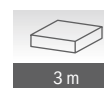
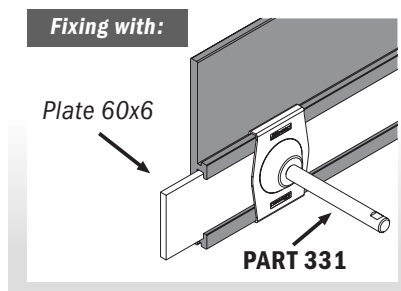
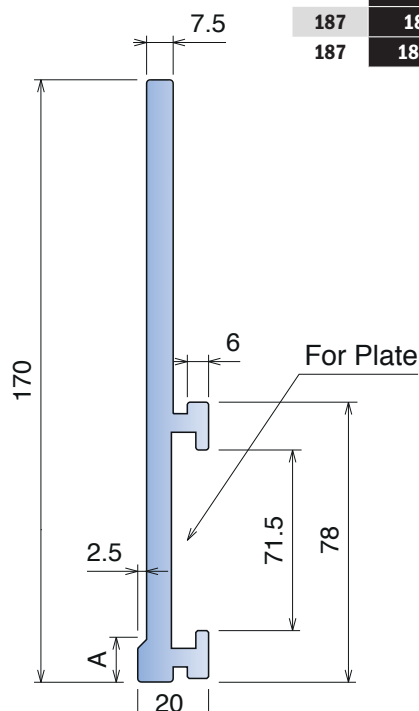
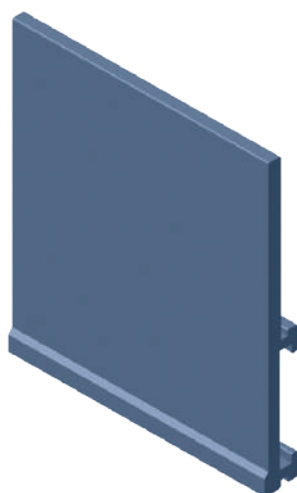

1056-1057

Guide estruse / Extruded profiles / Extrudiertes Profil

Material: Polyethylene HMW-PE

BluLub, new material with reduced coefficient of friction and higher wear resistance.

BluLub complies with the code of Federal Regulations of FDA. Linear expansion coefficient:

$1.1 \times 10^{-4} \text{ } ^\circ\text{F}^{-1}$ ($2 \times 10^{-4} \text{ } ^\circ\text{C}^{-1}$) Operating temperature: -40 to $176 \text{ } ^\circ\text{F}$ (-40 to $+80 \text{ } ^\circ\text{C}$)

1056

Guida laterale
Side guide rail / Seitenführung

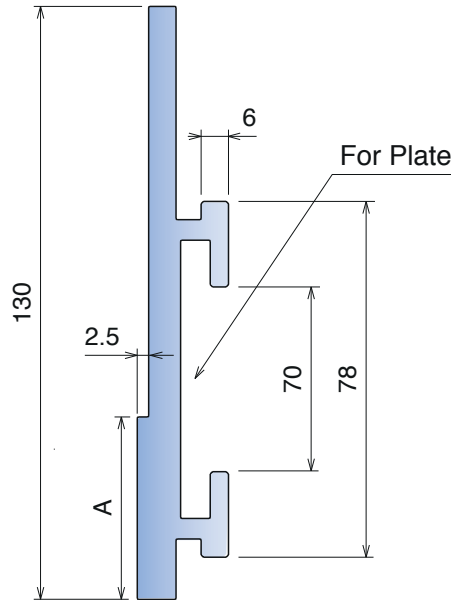
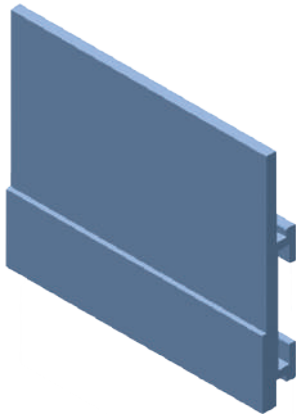

Fixing with:

Plate 60x6

PART 331



3 m

1057

Guida laterale
Side guide rail / Seitenführung

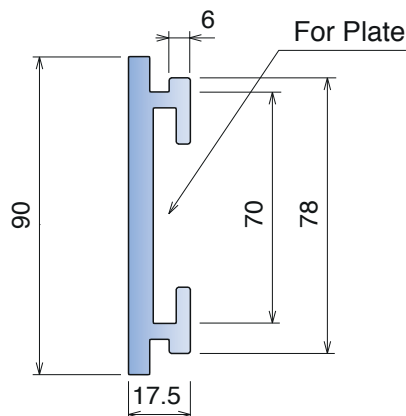
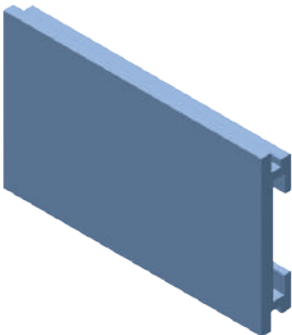

Fixing with:

Plate 60x6

PART 331



3 m

Part	Article-Nr.	L	A	For plate	Material	Availability
1056	105604C	3 m	10	60x6	grey	Stock item
1056	105600BC	3 m	10	60x6	BluLub	Stock item
1056	105634C	3 m	40	60x6	grey	Stock item
1056	105630BC	3 m	40	60x6	BluLub	Stock item

Part	Article-Nr.	L	For plate	Material	Availability
1057	105704C	3 m	60x6	grey	Stock item
1057	105700BC	3 m	60x6	BluLub	Stock item

Material: Polyethylene HMW-PE
BluLub, new material with reduced coefficient of friction and higher wear resistance.
 BluLub complies with the code of Federal Regulations of FDA. Linear expansion coefficient:
 $1.1 \times 10^{-4} \text{ } ^\circ\text{F}^{-1}$ ($2 \times 10^{-4} \text{ } ^\circ\text{C}^{-1}$) Operating temperature: -40 to 176°F (-40 to +80°C)

186 Guida laterale Side guide rail / Seitenführung

Part	Article-Nr.	L	For plate	Material	Availability
186	18604C	3 m	50x6	grey	On request
186	18600BC	3 m	50x6	BluLub	On request

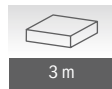
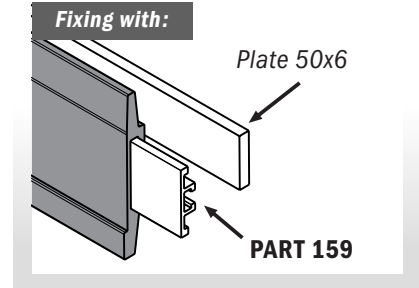
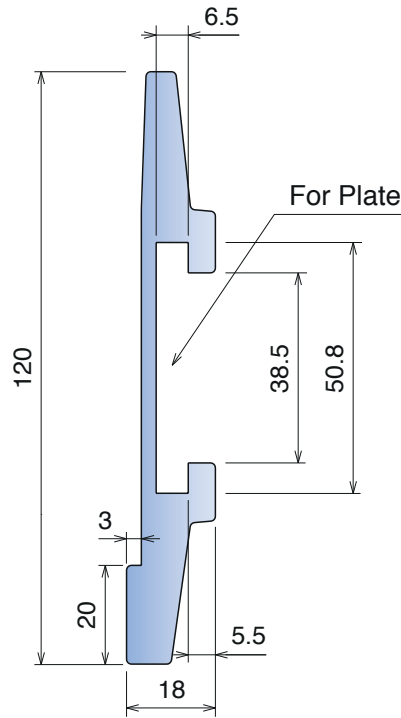
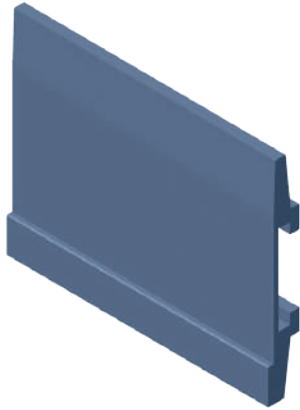

1061 Guida laterale Side guide rail / Seitenführung

Part	Article-Nr.	L	For plate	Material	Availability
1061	106104C	3 m	60x6	grey	On request
1061	106104BC	3 m	60x6	BluLub	On request

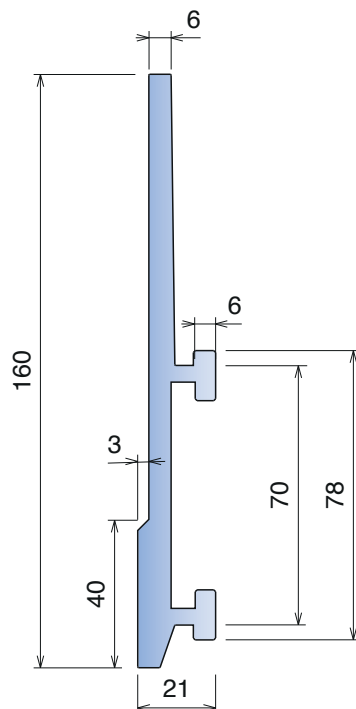
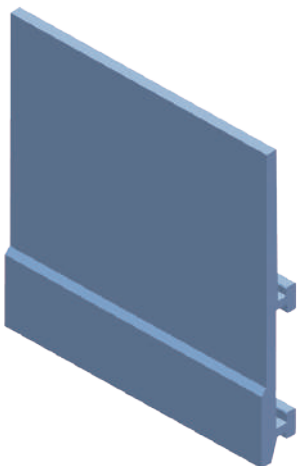

Material: Polyethylene UHMW-PE with molecular density 9,200,000 g/mo.
BluLub, new material with reduced coefficient of friction and higher wear resistance.
 BluLub complies with the code of Federal Regulations of FDA. Linear expansion coefficient:
 $1.1 \times 10^{-4} \text{ } ^\circ\text{F}^{-1}$ ($2 \times 10^{-4} \text{ } ^\circ\text{C}^{-1}$) Operating temperature: -40 to 176°F (-40 to +80°C)

166 Profilo per rondini Round profile for steel rods / Clip-on Profil für Rundmaterial

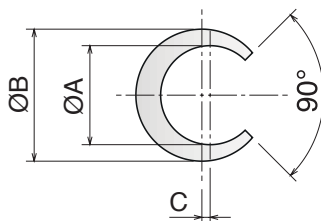
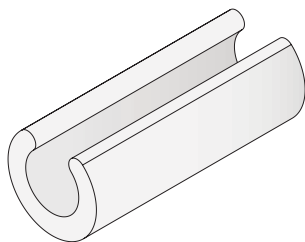

Part	Article-Nr.	A	B	C	Colour	Availability
166	16601	8	12	0,5	white	Stock item
166	16602	10	14	0,5	white	Stock item
166	16603	12	16	1	white	Stock item
166	16604	16	20	1,5	white	Stock item



30 m

1039 Profilo per mezzitondi Half round profile for steel rods / Halbmond Profil

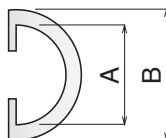
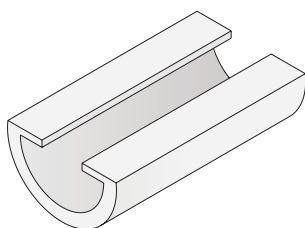

Part	Article-Nr.	L	A	B	Colour	Availability
1039	103923C	3 m	16	20	white	Stock item
1039	103923	6 m	16	20	white	On request
1039	103923-30	30 m	16	20	white	On request
1039	103923-60	60 m	16	20	white	On request



3/6 m



30/60 m

183 Guida laterale Side guide rail / Seitenführung

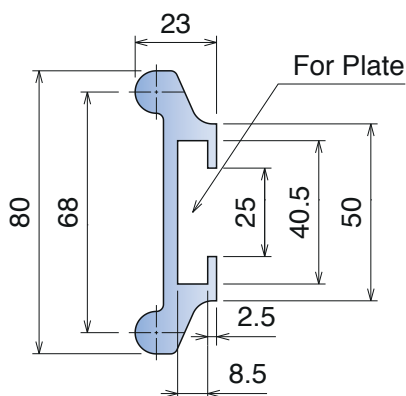
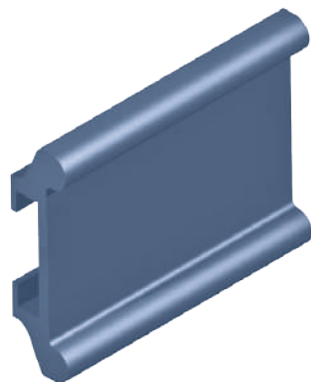

Part	Article-Nr.	L	Colour	Availability
183	18301C	3 m	black	Stock item
183	18301	6 m	black	On request
183	18301BC	3 m	BluLub	Stock item
183	18301B	6 m	BluLub	On request

Fixing with:

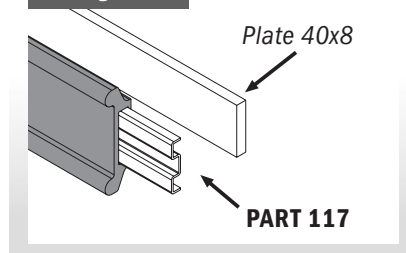

3/6 m

113

Pattino guida catena, centrale
 Central wear strip shoe / Zentraler Einlaufschuh

Part	Article-Nr.	Colour	Availability
113	11301	black	On request

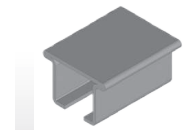
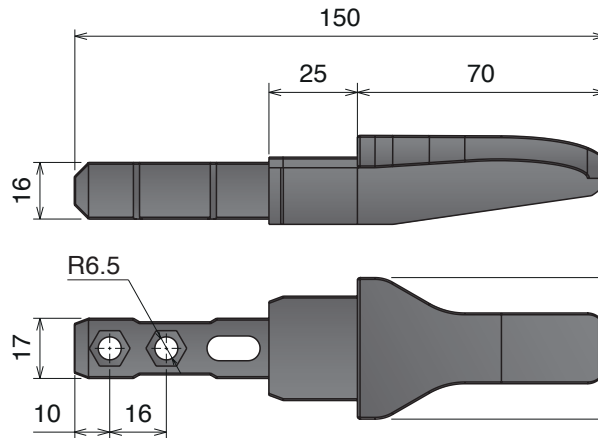

Used with
 SS Profile:
PART 112
 Pag 281

Part	Article-Nr.	Colour	Availability
113	11302	black	On request

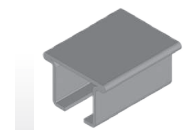
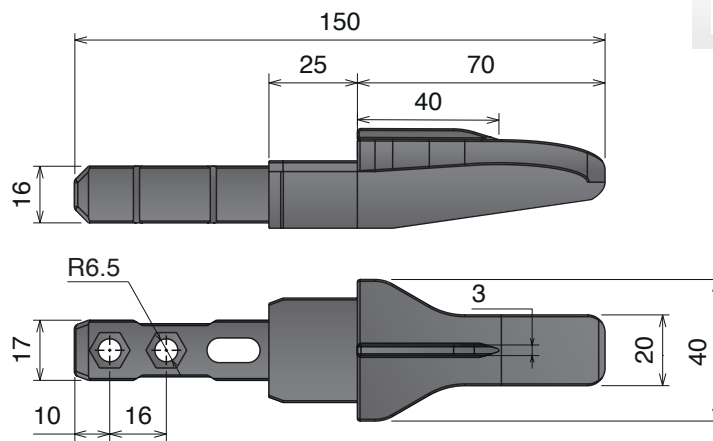

Used with
 SS Profile:
PART 112
 Pag 281

CON NERVATURA
WITH NOSE / MIT NASE

114

Blocchetto fissaggio
 Fixing clamp / Fixierblock

Part	Article-Nr.	A	B	C	Colour	Availability
114	11401	10	6,2	4,5	black	On request
114	11402	13	8,2	6	black	On request

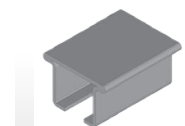
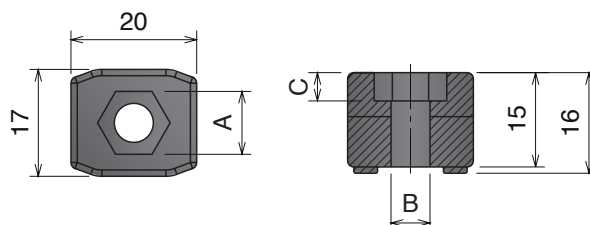

Used with
 SS Profile:
PART 112
 Pag 281

116 Pattino guida catena, laterale Side transfer guide shoe / seitlicher Tranferschuh



Part	Article-Nr.	Colour	Availability
116	11601	black	On request

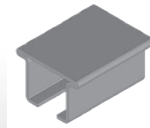

Used with
 SS Profile:
PART 112
 Pag 281

← LEFT VERSION

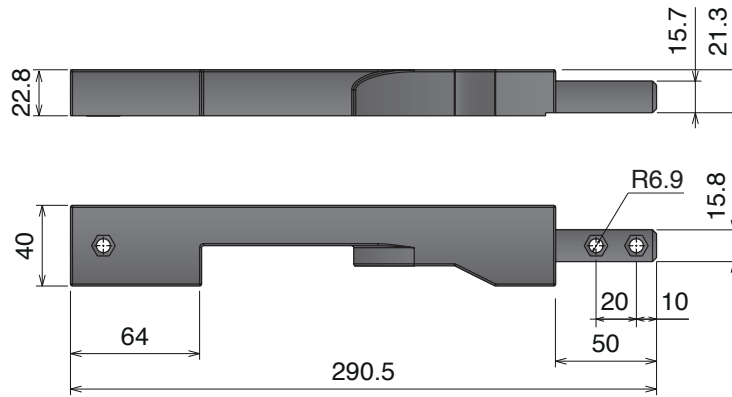

Part	Article-Nr.	Colour	Availability
116	11602	black	On request

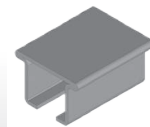

Used with
 SS Profile:
PART 112
 Pag 281

RIGHT VERSION →

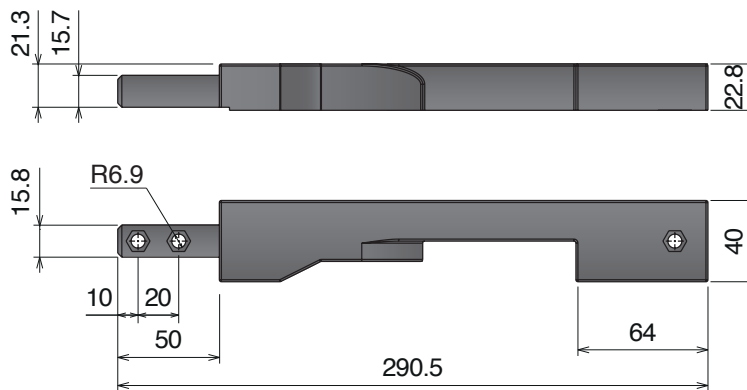

115 Blocchetto giunzione Connecting element / Verbindungselement



Part	Article-Nr.	A	B	C	Colour	Availability
115	11501	10	6,2	4,5	black	On request
115	11502	13	8,2	6	black	On request

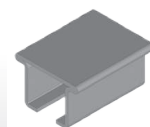

Used with
 SS Profile:
PART 112
 Pag 281

