

Serie Light

SR250L/LI/LE Nylon Cable Chain

Inner height (D) 17 mm

Single link construction.

Non-openable version (SR250L).

Version with openable frames from inner radius (SR250LI) or from outer radius (SR250LE).

Vertical separators available.

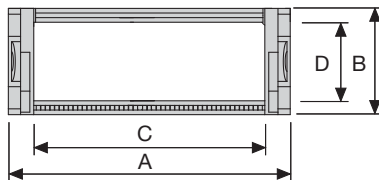

SR250L

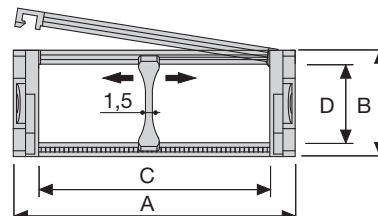

SR250LI/LE

Separator

- Unassembled	Part.no S250L
- Assembled	Part.no S250LMC

Technical characteristics when self-supported

Speed	10 m/s
Acceleration	50 m/s ²

For higher requirements please consult our technical dept.

A	B	C	D	R	Weight/m	Chain
mm	mm	mm	mm	mm	kg	Part Number
26	23	15	17	028-038-045-060-075-100	0,34	SR250L(LI)(LE)015□□□*
36	23	25	17	028-038-045-060-075-100	0,37	SR250L(LI)(LE)025□□□*
46	23	35	17	028-038-045-060-075-100	0,40	SR250L(LI)(LE)035□□□*
61	23	50	17	028-038-045-060-075-100	0,43	SR250L(LI)(LE)050□□□*

*Complete the code by inserting the value of the radius (R): Ex. SR250LI035□□□□

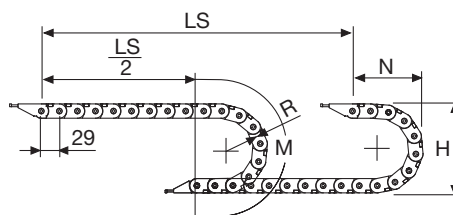

Length of chain (L)

Half travel distance ($\frac{LS}{2}$)
plus length of curve (M)

$$L = \frac{LS}{2} + M$$

R	H	N	M
mm	mm	mm	mm
028	79	68,5	146
038	99	78,5	177
045	113	85,5	199
060	143	100,5	246
075	173	115,5	294
100	223	140,5	372

SR250L

Non-openable



SR250LI

Frames openable from inner radius



SR250LE

Frames openable from outer radius



Self-Supporting Capacity Diagram

The maximum length of the self-supporting capacity ($\frac{LS}{2}$) in relationship to the weight of the cables and hoses contained per linear metre.

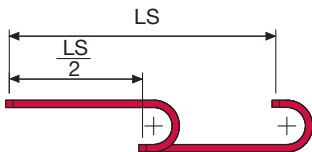
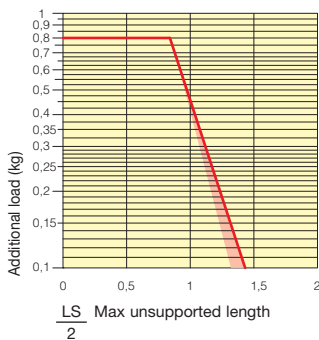

The red marking in the diagram area considers the difference of weight between various widths of chain.

For applications with $\frac{LS}{2}$ and weights not included in the area of the diagram showing self-supporting capacity, verify the possible use of support rollers (see page 30).

End Brackets

The end brackets set allows the two ends of the chain to be attached to the equipment. End brackets are equipped with tiewrap clamps.

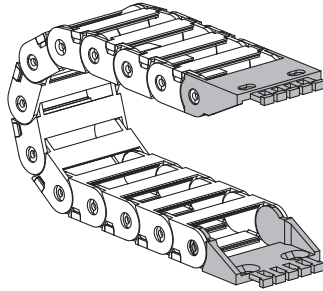
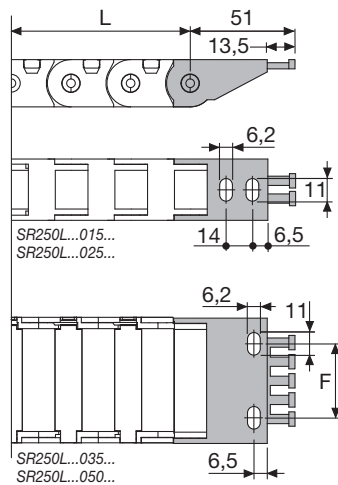

Fig. A
Chain fixed outside the radius. (Fig A)
See end brackets mounting variations page 31..



Chain Type	F1 mm
SR250L...035...	21
SR250L...050...	36

Nylon Type Part Numbers

Complete Set Assembled	
Chain	End Brackets
Type	Set
SR250L	AN250L□□□*KM□**

Complete Set Unassembled	
Chain	End Brackets
Type	Set
SR250L	AN250L□□□*K□**

* Inner width (C)
** 1=Pos.1; 2=Pos.2; 3=Pos.3
5=Pos.5; 6=Pos.6

Serie Light

SR250L SR250LI SR250LE

Nylon Cable Chain

3

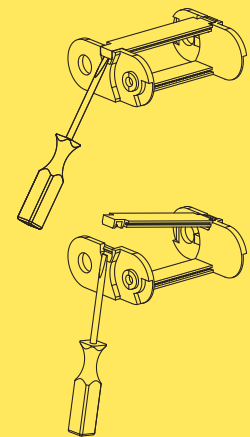

How to open the cover.

For further information please consult Brevetti Stendalto's Technical Office